

Influence of microstructure and surface finishing on the hard anodizing of diecast Al-Si-Cu alloys

D. Caliarì, G. Timelli, T. Salata, G. Cavagnini, S. Maestri, A. Manfredini

The effect of microstructure and surface finishing on the hard anodizing of diecast Al-Si-Cu alloys is reported. The anodic oxide layer obtained from diecast AlSi9Cu3(Fe), AlSi11Cu2(Fe) and AlSi12Cu1(Fe) alloys has been analysed. Diecast plates have been anodized in as-diecast condition and after milling process. Metallographic and image analysis techniques have been used to quantitatively examine the variations of the oxide layer in terms of thickness and morphology. The final quality of the hard-anodized surfaces, in terms of colouration defects, has been evaluated by means of a surface quality index. The results indicate how the thickness of the anodic layer is strongly influenced both by the initial Cu content in the alloy and the local eutectic fraction in the substrate before anodizing. The anodizing response seems to be more related to the amount of α -Al phase than the size of eutectic Si particles when these are relatively fine. The diecast AlSi12Cu1(Fe) alloy shows the best response to anodizing mainly due to the reduced Cu level if compared to the other diecast alloys. The anodic layer obtained on a substrate containing lower eutectic fraction is generally thicker and shows lower colouration defects.

KEYWORDS: HARD ANODIZING – HIGH-PRESSURE DIE-CASTING – AL-SI-CU ALLOYS
– MICROSTRUCTURE – COLOURATION DEFECTS.

INTRODUCTION

Aluminium foundry alloys are among the most interesting materials being adopted for weight reduction, especially in the automotive sector. An increasing number of parts such as steering gearboxes or structural components are being manufactured from aluminium alloys by high-pressure die-casting (HPDC), which is a competitive and high-production rate foundry technology, suitable for complex shaped-castings.

Typical Al alloys used in HPDC are hypoeutectic Al-Si, Al-Si-Cu and Al-Mg-Si casting alloys, in order to provide castability, strength resistance and ductility [1]. Even if the selection of the alloy composition can be optimised according to the specific design and casting conditions of the component, it is important to find a compromise between mechanical properties and reasonable material cost.

Secondary Al foundry alloys show lower cost than primary ones, but present small amount of a lot of elements and impurities, with wider composition tolerance limits respect to primary alloys. These characteristics are a consequence of the recycling process and can have negative effects on the surface characteristics and final quality of the components [2].

Anodizing treatment is one of the most important surface processes for Al alloys. It is generally used to produce decorative and protective oxide layer over the surface of cast components. Anodizing is an electrolytic passivation used for increasing the thickness of the natural Al oxide layer on the surface through a direct electric current [3]. Two types of anodizing process are

known, which are generally referred as normal anodizing and hard anodizing. The latter is suitable for increasing the corrosion resistance in highly corrosive environment, and for improving both surface hardness and wear resistance.

The initial chemical composition of the alloy, the presence of defects on casting surface, complex intermetallic phases and eutectic segregations in diecast components can significantly affect the growth of the anodic oxide layer during the anodizing process. It is known that eutectic Si and intermetallic particles, such as Mg₂Si, β -Al₅FeSi, α -Al(Fe,Mn,Cr)Si, Al₂Cu phases, are very harmful for anodizing [3-5].

Secondary intermetallic compounds such as Cu- and Fe-bearing

Daniele Caliarì, Giulio Timelli*

University of Padova, Department of Management and Engineering,
Stradella S. Nicola, 3 I-36100 Vicenza, Italy.

*timelli@gest.unipd.it

**Tiziano Salata, Giuseppe Cavagnini,
Sergio Maestri, Andrea Manfredini**

Alfa Ossidazione srl, Via Dott. De Troya 65/67,
Borgosatollo (BS), Italy

particles become cathodic during anodizing [5,6]. This leads to form voids, porosity and trenches in the substrate and inside the oxide layer. The casting regions affected by surface Si segregation can show a thickness ranging from 0.7 to 1.1 mm [7]; this leads to a non-homogeneous distribution of the eutectic amount. Greater content of eutectic Si in the substrate may induce thinner oxide layers and surface damages, which appear as aesthetical defects on the casting surface such as coloured spots [8-9].

Furthermore, diecastings are near-net shape components, but they often require surface mechanical finishing such as milling, tumbling, vibratory treatment or blasting [10]. It seems that casting defects and surface inhomogeneity can be found mainly where the casting surface has not been mechanically machined or finished [5]. These processes can remove the surface segregation and many intermetallic compounds formed close to the casting surface.

The present work is focused on understanding the influence of the microstructure and surface finishing on the hard anodizing of diecast Al-Si-Cu-(Fe) based alloys. The anodic oxide layer formed on diecast AlSi9Cu3(Fe), AlSi11Cu2(Fe) and AlSi12Cu1(Fe)

alloys was analysed. The investigated surfaces were anodized both in as-diecast condition and after surface milling operation.

Experimental procedure

Alloys and diecasting process

Secondary AlSi9Cu3(Fe), AlSi11Cu2(Fe) and AlSi12Cu1(Fe) casting alloys (according to EN 1676:2010 designation) were supplied as commercial ingots and used as baselines. These are secondary Al alloy, which are among the most commonly used die-casting alloys in Europe [11].

The ingots were melted and held in a 300-kg gas fired crucible furnace and degassed with an argon-sulphur hexafluoride mixture (Ar/SF6 0.2%) to conform with established foundry practices. A detailed description of the treatments performed on the molten bath is described elsewhere [12]. The chemical compositions, measured on separately poured samples, are shown in Table 1. The alloys mainly differ from the Si and Cu amounts, which are typical alloying elements useful to increase the castability and the mechanical properties of the alloy, respectively.

Tab. 1 – Chemical compositions of the experimental alloys (wt.%).

Alloy	Si	Fe	Cu	Mn	Mg	Cr	Ni	Pb	Zn	Sn	Ti	Al
AlSi9Cu3(Fe)	8.23	0.80	2.82	0.26	0.25	0.08	0.08	0.08	0.89	0.03	0.04	bal.
AlSi11Cu2(Fe)	10.89	0.89	1.75	0.22	0.22	0.08	0.08	0.09	1.27	0.03	0.05	bal.
AlSi12Cu1(Fe)	10.51	0.72	0.94	0.23	0.24	0.04	0.08	0.05	0.35	0.02	0.04	bal.

Casting was carried out by using an Italtipresse IP300 cold chamber die-casting machine with a locking force of 2.9 MN. A multicavity die was used to produce high-pressure diecast specimens with geometry shown in Figure 1a. The die design and the process parameters were selected to minimize casting defects. The weight of the Al alloy diecasting was 0.9 kg, including the runners, gating and overflow system. Details of the casting procedure and die geometry are described in previous works [12,13].

The diecastings have been stored at room temperature for at least 5 months before being analysed and were, therefore, similar to a T1 condition. Generally, this temper designation applies

to products that are cooled from an elevated-temperature shaping process, like high-pressure die-casting, and for which mechanical properties have been stabilized by room-temperature aging.

This work only examined the diecast plate from the position indicated in Figure 1a. Each plate was cut in order to draw 60 x 60 mm₂ specimens (Figure 1b). The AlSi9Cu3(Fe) and AlSi11Cu2(Fe) alloy plates were 3-mm thick, whereas the AlSi12Cu1(Fe) alloy ones showed a thickness of 6 mm. A threaded hole was made in each specimen (see Figure 1b) to fix it in the anodizing racking system.

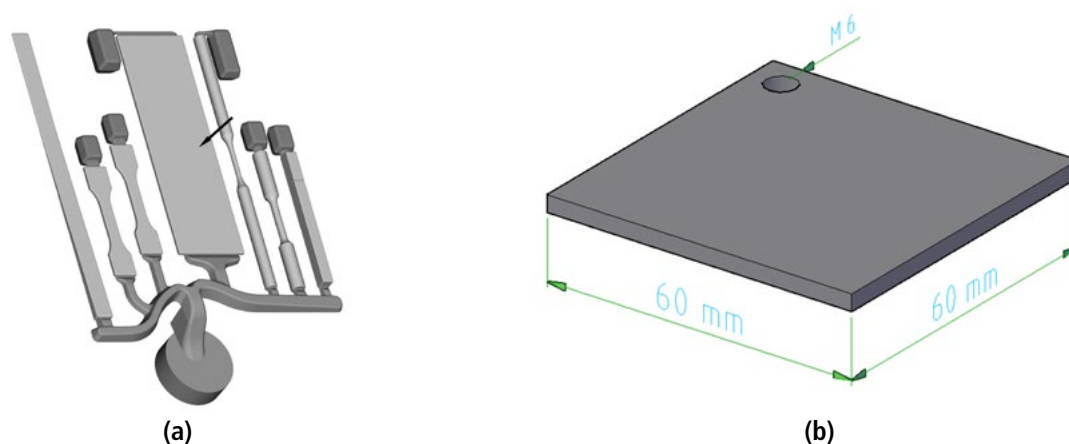

Fig. 1 – (a) Geometry of the die-casting, where the investigated plate is indicated by arrow; (b) dimensions of the drawn specimen that was hard-anodized and analysed in the present work.

Machining operation

A set of plates was studied in as-diecast condition, while a second set was mechanically milled to remove a surface layer of 1.0 ± 0.2 mm of material. In particular, the milling depth was set in order to remove the surface eutectic segregation typical of diecastings [14]. The milling operation was conducted using a vertical milling machine where the cutting tool used was 25 mm diameter with cutting high-speed steel (HSS) inserts. The depth of cut was set at 1 mm, while the feed rate and the spindle speed were 100 mm/min and 1000 rpm, respectively. The surface roughness R_a showed both by as-diecast and milled surfaces was 1.1 ± 0.2 μm .

Hard-anodizing parameters

The specimens were preliminary treated for hard-anodizing process by etching in a 5% NaOH solution and then cleaned with deionised water. The specimens were then anodised in a 220 g/l H_2SO_4 solution at 0°C with an electric current density of 250 A/m² for 80 minutes. A steady state was reached after 20 minutes. After anodising, the specimens were cleaned with

deionised water, sealed in a water solution of NiF_2 and CoF_2 at room temperature for 30 minutes. A set of 8 specimens was hard-anodized for each condition.

Evaluation of surface quality

Colouration defects as defined in Ref. [9] were evaluated on the surface of hard-anodized specimens. Only the surface of the plate in contact with the ejector side of the die was investigated.

A surface quality index was defined specifically to provide the final surface quality of hard-anodized specimens as function of the initial chemical composition of the alloy and surface finishing condition.

A 7 X7 grid was placed over the surface of the specimen, as shown in Figure 2, in order to count the sectors unaffected by colouration defects. The size of each grid square was 8 X 8 mm². The surface quality index was here defined as the ratio between the number of grid squares unaffected by coloured spots and the total of 49-unit squares.

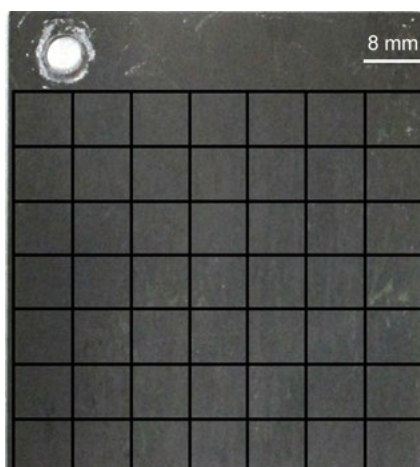

Fig. 2 – Grid placed over the specimen surface to measure the amount of colouration defects after hard anodizing.

Metallographic characterization

Samples drawn from the cross section of the plates were mechanically prepared to a 3- μm finish with diamond paste and, finally, polished with a commercial fine silica slurry. Microstructural analysis was carried out using an optical microscope (Leica DM 2500) and a field-emission gun scanning electron microscope (FEG-SEM, Quanta™ FEI 250) operating at 20 kV and coupled with energy-dispersive spectrometer (EDS, Edax). The polished specimens were also etched in a modified Murakami etchant (60 mL H₂O, 10 g NaOH, and 5 g K₃Fe(CN)₆) to quantitatively evaluate the eutectic fraction. At low magnification, the α -Al phase and the Al-Si eutectic and secondary intermetallic compounds appeared white and black, respectively, and, therefore, easily distinguishable by an image analyser.

Results and discussion

General microstructure

Typical microstructures obtained from the cross section of as-diecast and milled alloy plates are shown in Figure 3. The primary α -Al crystals and intermetallic compounds appear with light grey tone, while the Al-Si eutectic appears darker.

In most regions of the investigated plates, the diecast microstructure consists of primary α -Al grains with equiaxed morphology surrounded by Al-Si eutectic. Larger bright α -Al crystals can however be observed in a matrix of fine globular-rosette in-cavity solidified grains. Such crystals, generally known as externally solidified crystals (ESCs), mainly form in the shot sleeve or during the melt transfer from the holding furnace to the shot sleeve, and they are injected into the die

cavity during die filling [14].

The eutectic fraction measured in the different alloy substrates is listed in Table 2. It is known that diecast Al-Si based alloys alloy generally shows multiple segregation phenomena [15]; the main one is represented by eutectic increase from the casting centre to the surface. It is supposed that this phenomenon results from a combination of inverse segregation and exudation [15].

These are typical microstructural features observed in Al-Si based diecastings, which are related to the solidification phenomena affecting the skin of the casting in contact with the die surface [14, 16]. In general, the experimental AlSi9Cu3(Fe) and AlSi11Cu2(Fe) alloy specimens showed a progressive decrease of eutectic amount from the casting surface toward the centre. Therefore, the milling operation removed a surface layer of material affected by eutectic segregation and exposed a substrate with lower eutectic fraction (see Table 2).

On the contrary, the AlSi12Cu1(Fe) alloy specimens did not show any appreciable variation in terms of eutectic fraction between surface and centre. Thus, the effect of milling operation on microstructural variations can be neglected.

Smaller eutectic Si particles are revealed at the casting surface due to high cooling rate where, consequently, fine and fibrous particles form (Figures 3a-c). On the other hand, the eutectic Si shows coarser plate-like morphology at the centre of the specimens, typical of unmodified Al-Si alloys. This behaviour was revealed to be independent of the investigated alloy.

Milling operation removed a surface layer of material (1.0 ± 0.2 mm) and exposed surfaces with significantly coarser Si particles (Figures 3d-f).

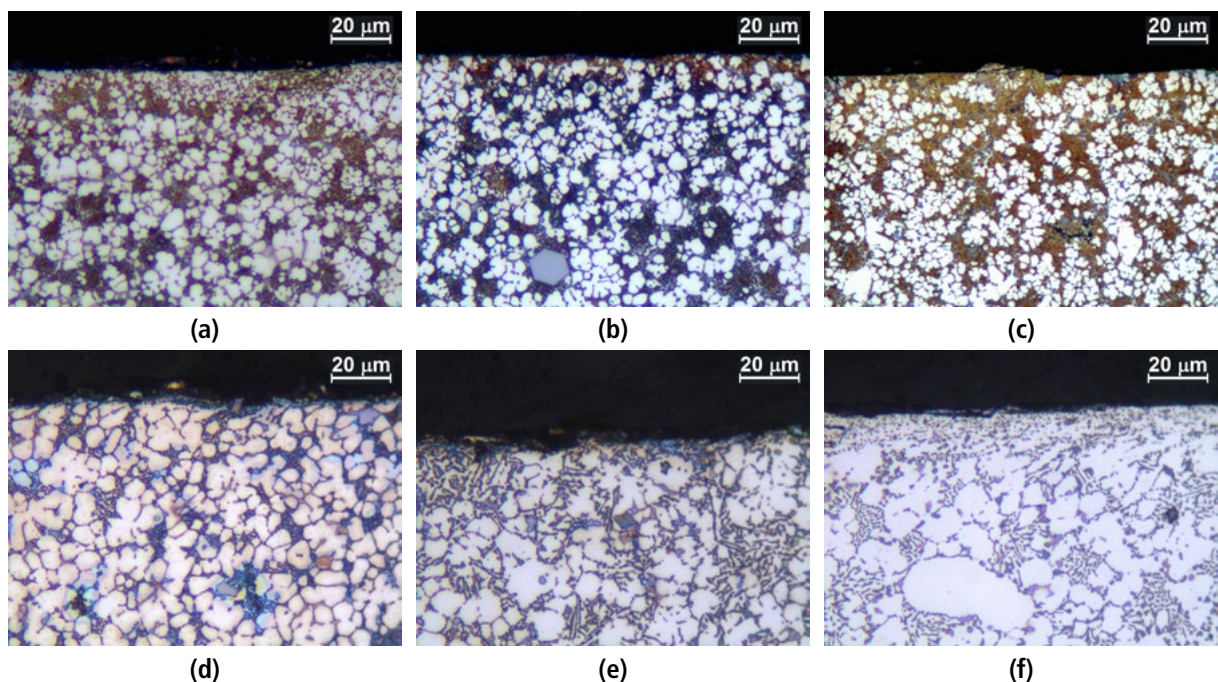

Fig. 3 – Typical etched microstructures of diecast (a,d) AlSi9Cu3(Fe), (b,e) AlSi11Cu2(Fe) and (c,f) AlSi12Cu1(Fe) alloys. The micrographs refer to (a,b,c) as-diecast and (d,e,f) milled surfaces.

Fig. 2 – Eutectic fraction measured in the cross section of as-diecast and milled alloy substrates.

Condition	AlSi9Cu3(Fe)	AlSi11Cu2(Fe) Cu	AlSi12Cu1(Fe)
As-diecast	0.47 ± 0.04	0.52 ± 0.04	0.52 ± 0.03
Milled	0.44 ± 0.02	0.48 ± 0.03	0.51 ± 0.02

Characterization of the anodic oxide film

Figures 4 and 5 show the variations of the anodic oxide layer as function of initial alloy composition and finishing condition. In general, the anodic layer appeared continuous and well bounded with the eutectic Si particles embedded inside the oxide layer, as shown by the EDS composition maps (Figure 6). The thickness of the oxide layer over the as-diecast substrates increases from AlSi9Cu3(Fe) alloy to AlSi11Cu2(Fe) alloy and AlSi12Cu1(Fe) alloy, i.e. by increasing the eutectic fraction and decreasing the initial Cu content. On the contrary, no significant differences in terms of oxide thickness were revealed after milling in the different alloy plates.

It is known that an Al alloy substrate without elemental segregation generally shows thicker and more compact anodic oxide layer [3-5,17,18]; on the contrary, greater Si and Cu contents

make the casting surface electrochemically heterogeneous and difficult to be anodized [19]. During the anodizing process the eutectic Si particles do not react and remain unchanged inside the anodic film [20], thus inducing a decreased oxidation velocity with respect to the region where only α -Al phase is present. This explains the greater thickness of the oxide layer in the milled surfaces, which show lower eutectic fraction and therefore greater amount of α -Al matrix.

On the other hand, the increased response to anodizing due to milling operation is less appreciable on as-diecast AlSi12Cu1(Fe) alloy. The difference in terms of eutectic fraction between milled and as-diecast surfaces was negligible in this alloy; furthermore, the AlSi12Cu1(Fe) alloy showed lower initial Cu content which makes the alloy suitable for anodizing.

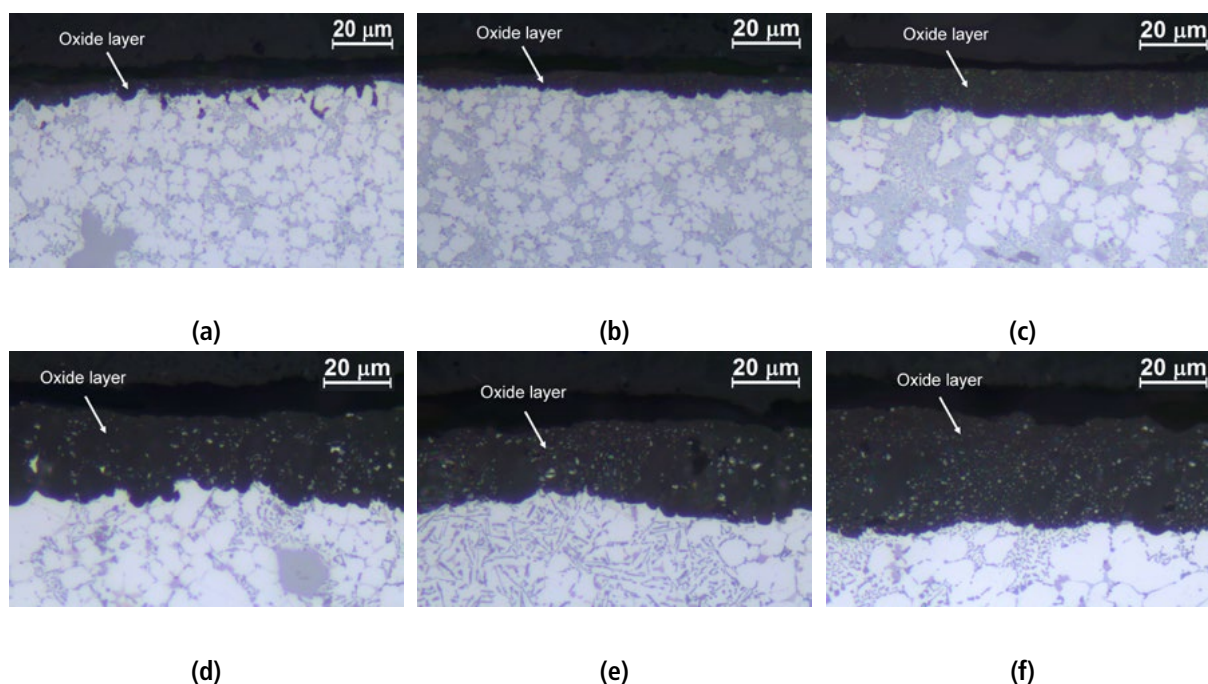

Fig. 4 – Anodic oxide layer formed on diecast (a,d) AlSi9Cu3(Fe), (b,e) AlSi11Cu2(Fe) and (c,f) AlSi12Cu1(Fe) alloy surfaces. The micrographs refer to the (a,b,c) as-diecast and (d,e,f) milled substrates.

All the investigated surfaces showed a size of the eutectic Si particles lower than 5 μm . It has been reported how this size is not deleterious for the growth and continuity of the anodic layer. The eutectic Si particles can be engulfed and embedded within the anodic layer, which appears thus continuous [5,20].

Particles with a size ranging between 5 and 20 μm can be also absorbed by the anodic layer but only with significant modifications of the oxidized film. Finally, Si particles greater than 20 μm produce clear damages and discontinuities of the oxide layer [20].

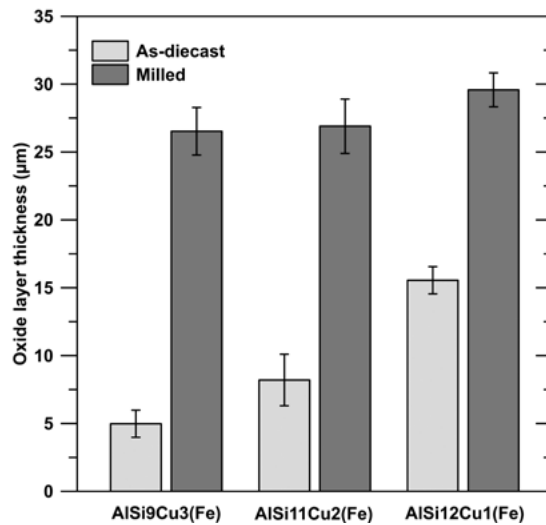
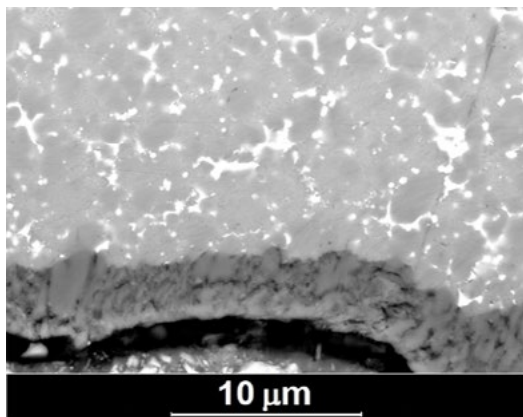

Fig. 5 – Thickness of the anodic oxide layer as function of the alloy composition and finishing condition. The scattering of data is depicted by vertical bars.

This also explains the thickest and continuous oxide layer over the AlSi12Cu1(Fe) alloy substrate, which showed fine eutectic Si particles as well as the AlSi9Cu3(Fe) and AlSi11Cu2(Fe) alloys, but lower Cu content. It is known how Cu is detrimental

for anodising even at low concentration; greater Cu content makes the casting surface electrochemically heterogeneous and difficult to be anodized.



(a)

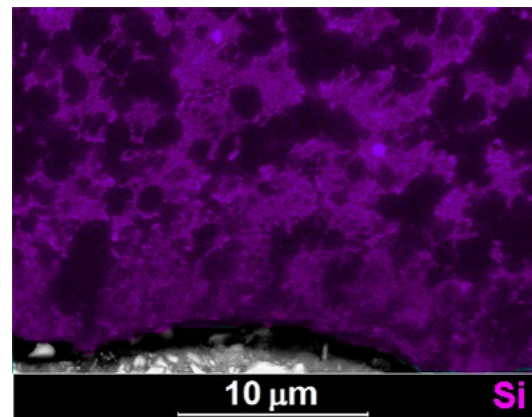

(b)

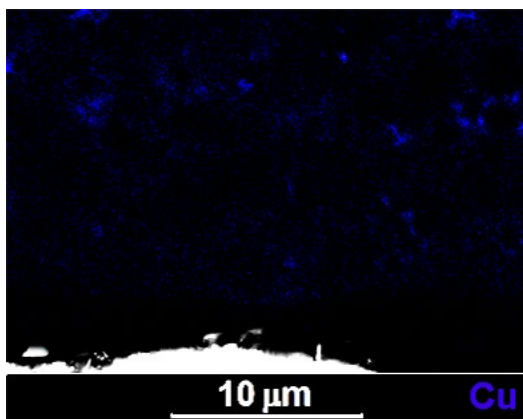

(c)

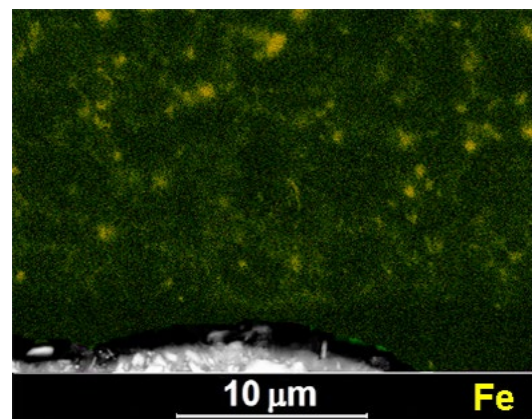

(d)

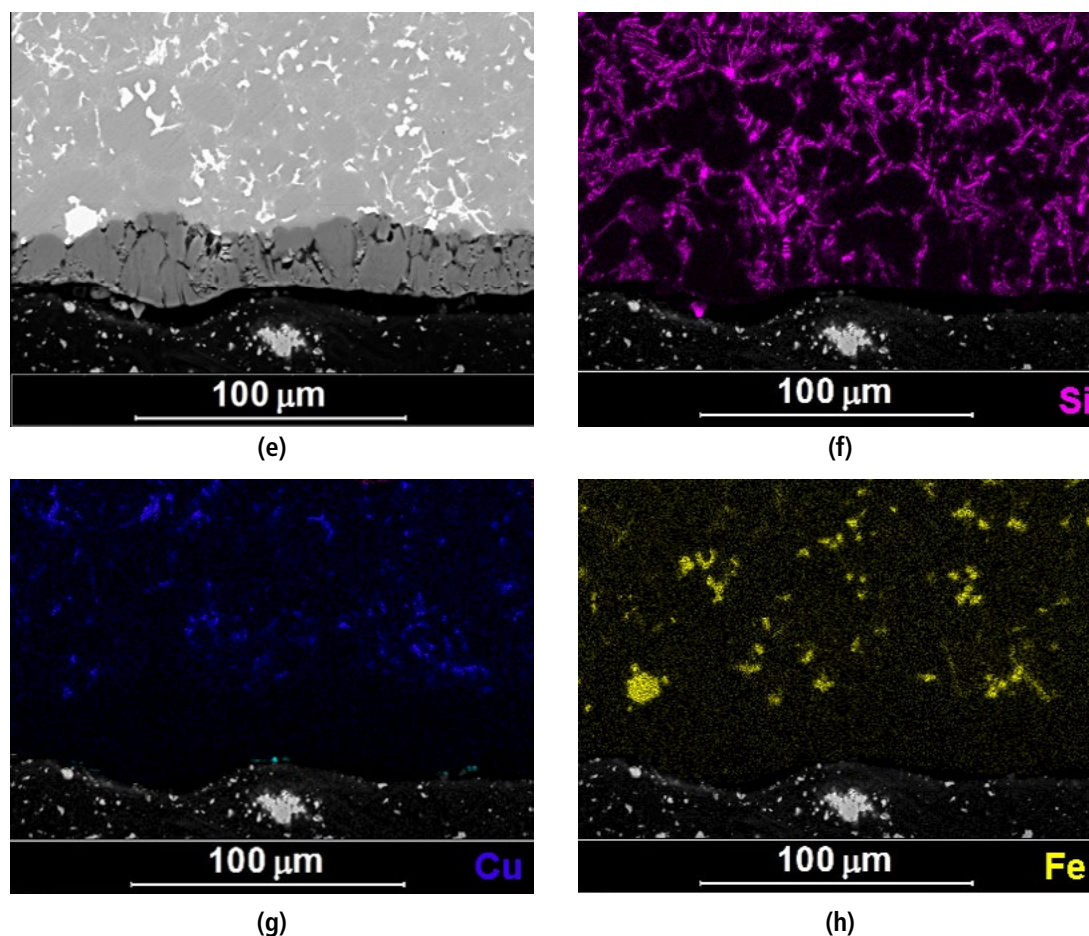

Fig. 6 – FEG-SEM micrographs of the anodic oxide layer with the corresponding EDS composition maps showing the distribution of Si, Cu and Fe elements in (a-d) as-diecast and (e-h) milled AlSi9Cu3(Fe) alloy surfaces.

No Cu- or Fe-bearing compounds were observed within the oxide layer as shown by the EDS composition maps (Figure 6). Saenz de Miera et al. [21] studied the effects of the Al-Cu-Fe intermetallic phases on the anodising response of Al alloys and observed the cathodic transformation of these intermetallics during the natural immersion. Thus, the α -Al matrix surrounding these particles dissolves faster; this results in trenches inside the substrate and around the particles, thus oxygen is extensively generated [3].

However, the initial presence of these intermetallics did not adversely affect the continuity of the anodic oxide layer in all the investigated conditions.

Surface quality evaluation

Figure 7 shows the variation of the previously defined surface quality index as function of the alloy composition and finishing condition.

The measured values for as-diecast plates increased by increasing the eutectic fraction and decreasing the initial Cu content (AlSi9Cu3(Fe) < AlSi11Cu2(Fe) < AlSi12Cu1(Fe)). It seems evident there exists a strict correlation between the presence of colouration defects and the thickness of the hard-anodic layer

obtained in as-diecast substrates. As described by Caliarì et al. [4], coloured spots may appear as surface defects in the anodized castings where the oxide layer is in a range between 3 and 8 μm; this behaviour is due to a poor response to anodizing of the substrate.

In general, Si particles do not react during anodizing, but part of them may oxidize; this leads to form gaseous oxygen and therefore voids inside the anodic layer. The presence of voids does not allow to produce a uniform anodic oxide growth and increases the probability to entrap contaminants. The latter may be already present on the surface of diecasting (e.g. oil, lubricant, powder), i.e. before the anodizing process, or inside the sulfuric anodizing solution [22].

Milled surfaces showed greater surface quality as shown in Figure 7; the lower eutectic fraction, i.e. lower Si content, respect to that measured in as-diecast substrates increased the aesthetic surface quality. Upon increasing the thickness of the oxide layer, the colouration defects of as-diecast plates reduced.

On the other side, the quality of the hard-anodized surfaces after milling operation increased with the sequence: AlSi9Cu3(Fe), AlSi11Cu2(Fe) and AlSi12Cu1(Fe). The oxide thickness resulted here almost constant.

Therefore, the amount of colouration defects is not only affected by the thickness of the anodic film, but also by the initial Cu content in the diecasting alloy, which is here minimum in the AlSi12Cu1(Fe) alloy (0.94 wt.%). This confirms how the Cu

level can significantly control the continuity of the anodic oxide film and induce colouration defects on the hard-anodized casting surface.

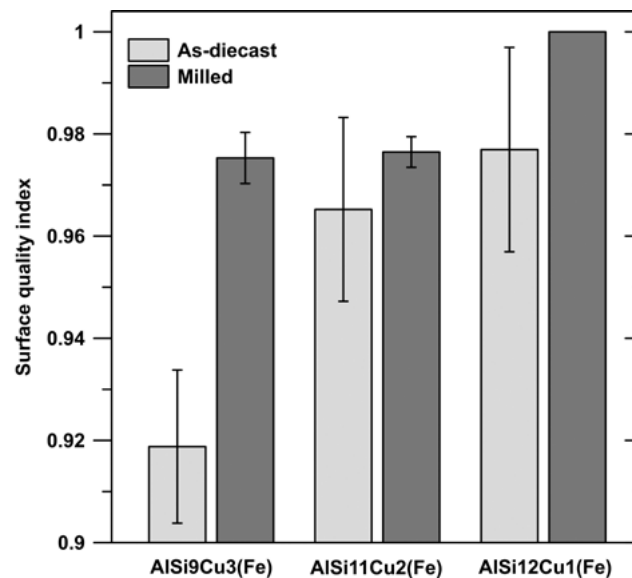

Fig. 7 – Variation of the surface quality of hard anodized surfaces in the different experimental conditions; the quality was evaluated by means of the surface quality index defined in §2.4.

CONCLUSIONS

The effects of the initial alloy composition and finishing conditions of the substrate on the hard-anodizing process in terms of oxide layer thickness and surface quality have been investigated. In particular, high-pressure die-cast AlSi9Cu3(Fe), AlSi11Cu2(Fe) and AlSi12Cu1(Fe) plates have been analysed. The following conclusions can be drawn.

- Lower the Cu amount, thicker the oxide layer will be, thus confirming that copper is detrimental for the anodic film growth even as a trace in the matrix. In particular, the AlSi12Cu1(Fe) substrate showed the best anodizing response among the investigated diecast alloys.
- Silicon particles showing sizes below 5 μm are not deleterious for the anodic layer growth and continuity.
- Milling operations which remove the surface macrosegregation lead to an increase in the anodizing response due to the lower amount of eutectic structure in contact with the sulphuric anodizing bath; this effect is more evident in AlSi9Cu3(Fe) alloy substrates.
- The aesthetical quality of the surface increases moving from AlSi9Cu3(Fe) to AlSi12Cu1(Fe) alloy, i.e. by decreasing Cu

amount.

- Milling surface operations increase the aesthetical quality of the anodic layer. This effect is related to the enhanced thickness of the oxide layer.
- An anodic layer containing entrapped Si particles is not always associated to the presence of surface defects.
- Among the investigated alloys, the AlSi12Cu1(Fe) alloy is suggested as suitable diecasting alloy when aesthetical requirements are demanded in industrial components, provided that the eutectic Si particles appear fine.
- When a great thickness of the oxide layer is demanded in hard anodized industrial applications, a milling operation is suggested in order to remove the surface layer of diecast material, provided that the eutectic Si particles appear fine in the machined substrate.

Acknowledgements

The authors would like to acknowledge Alfa Ossidazione Srl (Borgosatollo, Italy) for the financial and experimental supports to the research.

REFERENCES

- [1] D. Bosch, S. Pogatscher, M. Hummel, W. Fragner, P. J. Uggowitzer, M. Goken, H. W. Hoppel. Secondary Al-Si-Mg High-pressure Die Casting alloys with enhanced ductility, *Metall. Mater. Trans. A* 46 (2015) 1035-1045.
- [2] M.E. Schlesinger. *Aluminum Recycling*. 1st ed., Boca Raton, CRC Press, (2007) 176-192.
- [3] L. Chauke, H. Moller, U. A. Curle, G. Govender. Anodising of Al-Mg-Si-(Cu) alloys produced by R-HPDC, *Mater. Sci. Forum* 765 (2013) 658-662.
- [4] J. S. Shin, B. H. Kim, S. M. Lee, Effects of physical met treatments on microstructural evolution and anodizing characteristics of Al-Si casting alloys, *Mater. Sci. Forum* 695 (2011) 243-246.
- [5] D. Caliarì, G. Timelli, T. Salata, G. Cavagnini, S. Maestri. Surface defects of anodized HPDC Al alloy components, *Metall. Ital.* 108 (2016) 69-72.
- [6] F. Deflorian, S. Rossi, L. Maines, M. Fedel. Effect of metallic inclusions in the aluminum alloys anodising process, *Metall. Ital.* 100 (2008) 11-16.
- [7] S. Otarawanna, C.M. Gourlay, H.I. Laukli, A.K. Dahle. The thickness of defect bands in high-pressure die castings, *Mater. Character.* 60 (2009) 1432-1441.
- [8] ASTM B580-79. *Standard Specification for Anodic Oxide Coatings on Aluminum*, ASTM International, West Conshohocken, Philadelphia, PA, (2014) 1-3.
- [9] <http://www.defects.qualanod.net/index.html>
- [10] NADCA, *Product Specification Standards for Die Casting*, 9th edn. North American Die Casting Association, Arlington Heights, IL, (2015)
- [11] M. Conserva. StaCast Project - an update, *Diecasting & Foundry Techniques* 8 (2013) 28-29
- [12] G. Timelli, S. Ferraro, F. Grosselle, F. Bonollo, F. Voltazza, L. Capra. Mechanical and microstructural characterization of diecast aluminium alloys, *Metall. Ital.* 103 (2011) 5-17.
- [13] E. Zanini, S. Barison, L. Capra, G. Timelli, F. Voltazza. Microstructure and bending properties of die-casting alloys at various chromium contents, *Metall. Ital.* 104 (2012) 3-13.
- [14] G. Timelli, A. Fabrizi. The effects of microstructure heterogeneities and casting defects on the mechanical properties of high-pressure die-cast AlSi9Cu3(Fe) Alloys, *Metall. Mater. Trans. A*. 45 (2014) 5486-5498.
- [15] S. Otarawanna, C.M. Gourlay, H.I. Laukli, A.K. Dahle. Microstructure formation in AlSi4MgMn and AlMg5Si2Mn high-pressure die castings, *Metall. Mater. Trans. A* 40 (2009) 1645-1659.
- [16] S. Otarawanna, C.M. Gourlay, H.I. Laukli, A.K. Dahle. Formation of the surface layer in hypoeutectic Al-alloy high-pressure die castings, *Mater. Chem. Phys.* 130 (2011) 251-258.
- [17] J.S. Shin, B.H. Kim, S.M. Lee. A study on surface oxidation coating characteristics of Al-Si casting alloys, *Mater. Sci. Forum* 724 (2012) 173-177.
- [18] A. Forn, J.A. Picas, M.T. Baile, S. Menargues, V.G. Garcia. Anodic oxide layer formation on A357 aluminium alloy produced by thixocasting, *Solid. State Phenom.* 116-117 (2006) 80-83.
- [19] L.E. Fratila-Apachitei, J. Duszczuk, L. Katgerman. Vickers microhardness of AlSi(Cu) anodic oxide layers formed in H2SO4 at low temperature. *Surf. Coat. Tech.* 165 (2003) 309-315.
- [20] S. Ferlini, E. Costa, E. Ferri. Effetti del silicio nell'anodizzazione di leghe di alluminio, *Metall. Ital.* 98 (2006) 60-62.
- [21] M. Saenz de Miera, M. Curioni, P. Skeldon, G.E. Thompson. The behaviour of second phase particles during anodizing of aluminium alloys, *Corros. Sci.* 52 (2010) 2489-2497.
- [22] J. Runge, L. Chesterfield. The science of successfully anodizing die cast substrates, *Aluminium International Today* 6 (2010) 30-36.