

TAV. 1

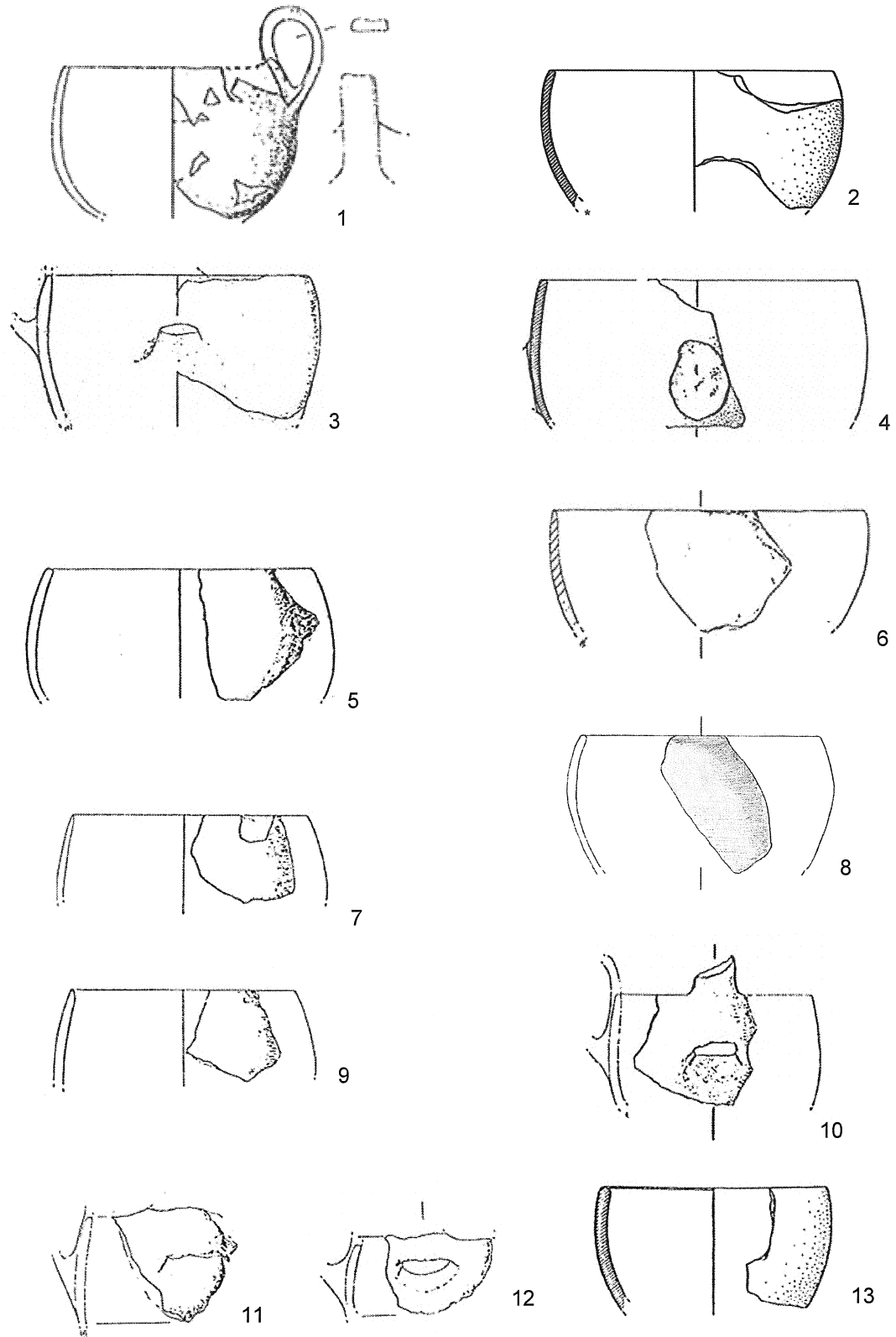

Tazze 1.1.a

TAV. 2

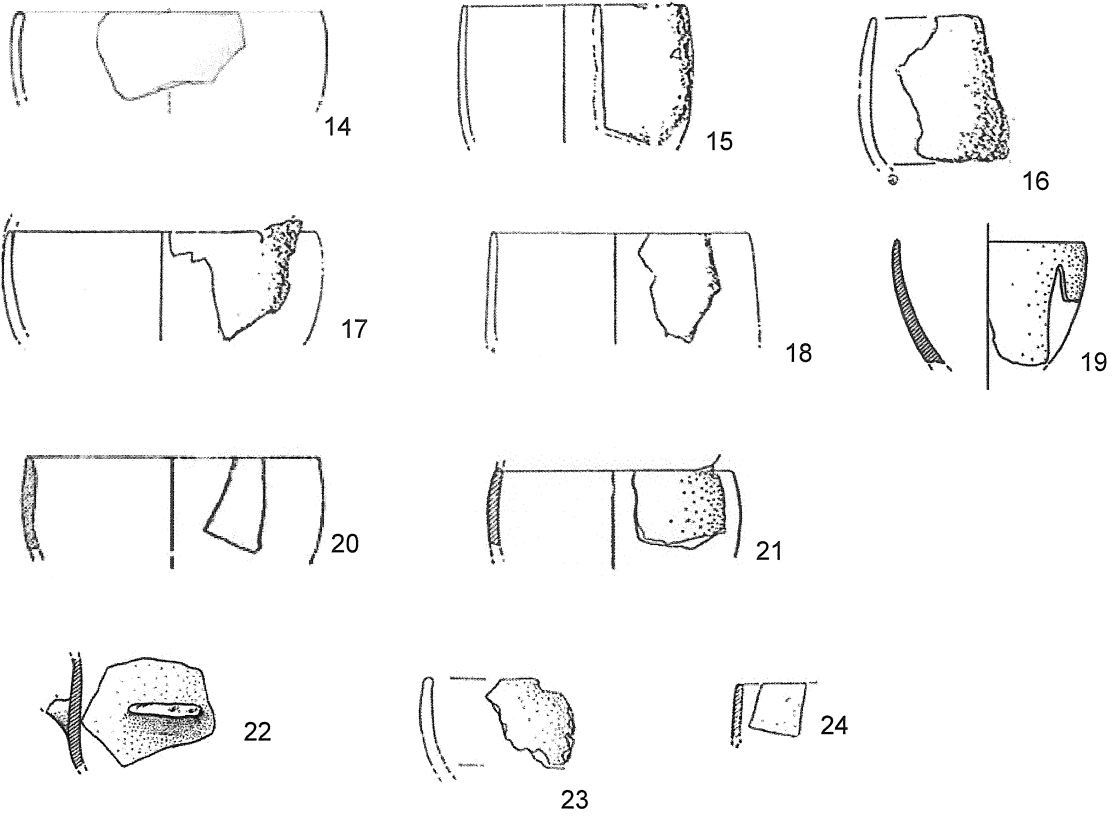

Tazze 1.1.a

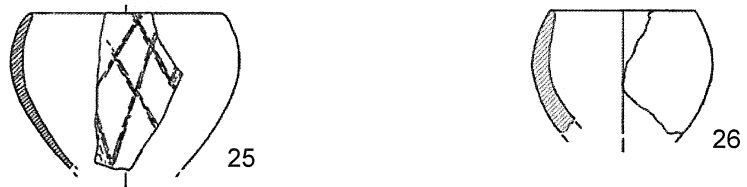

Tazze 1.1.b

TAV. 3



Tazze 2.1.a

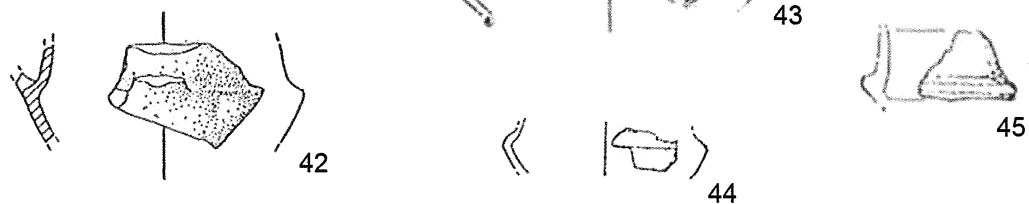
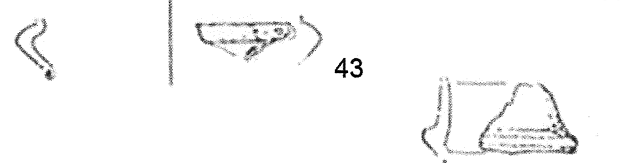
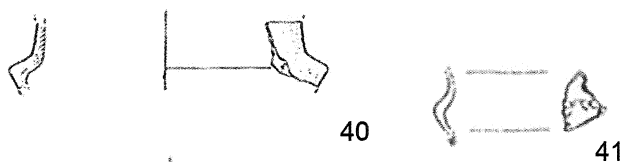
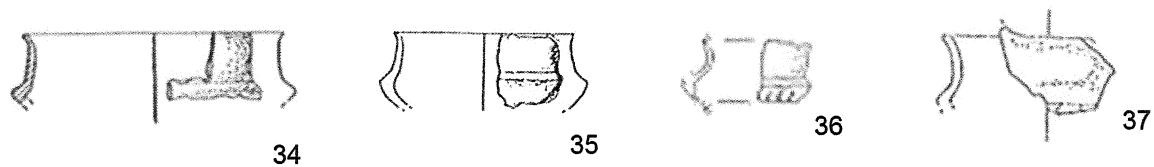
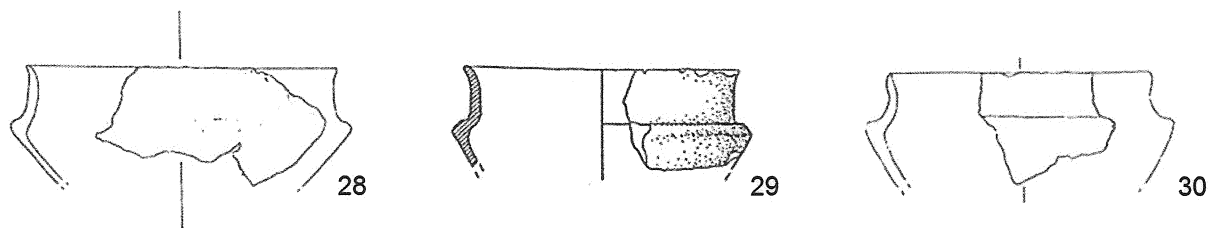

Tazze 2.1.b

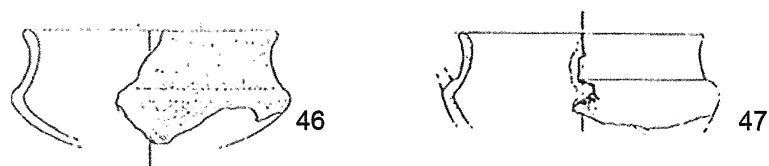

Tazze 2.1.c

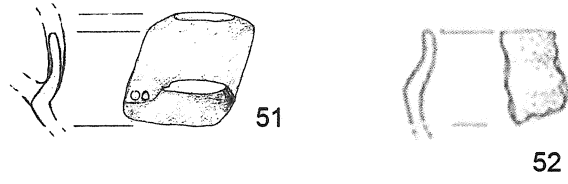

Tazze 3.1

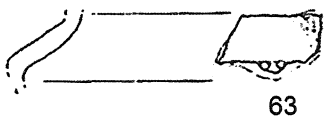
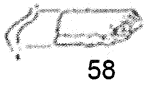
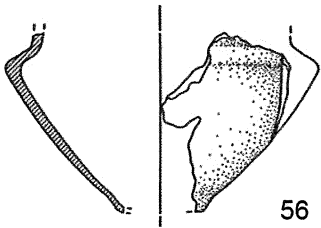
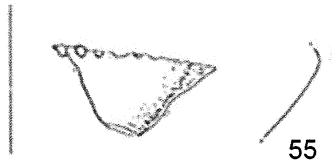
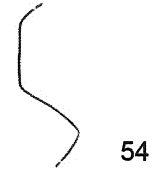
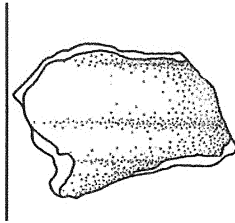
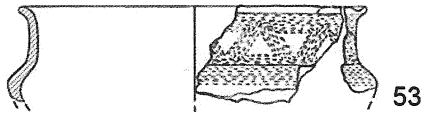

Tazze 3.2

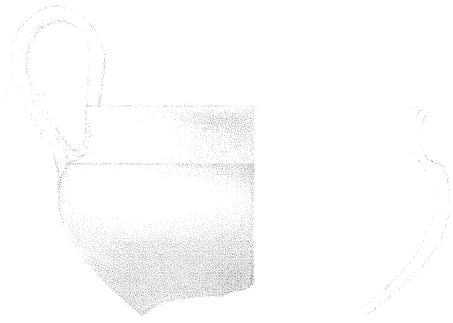

67

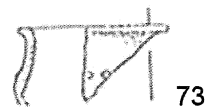
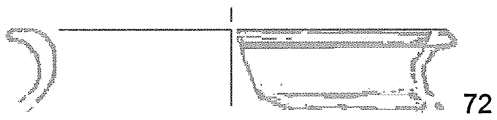
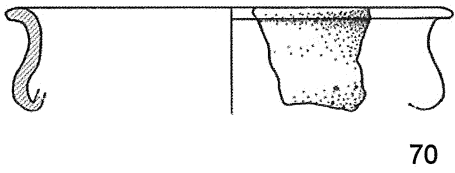
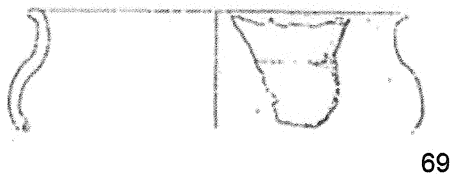
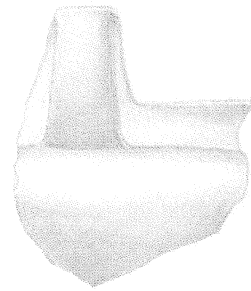

TAV. 6

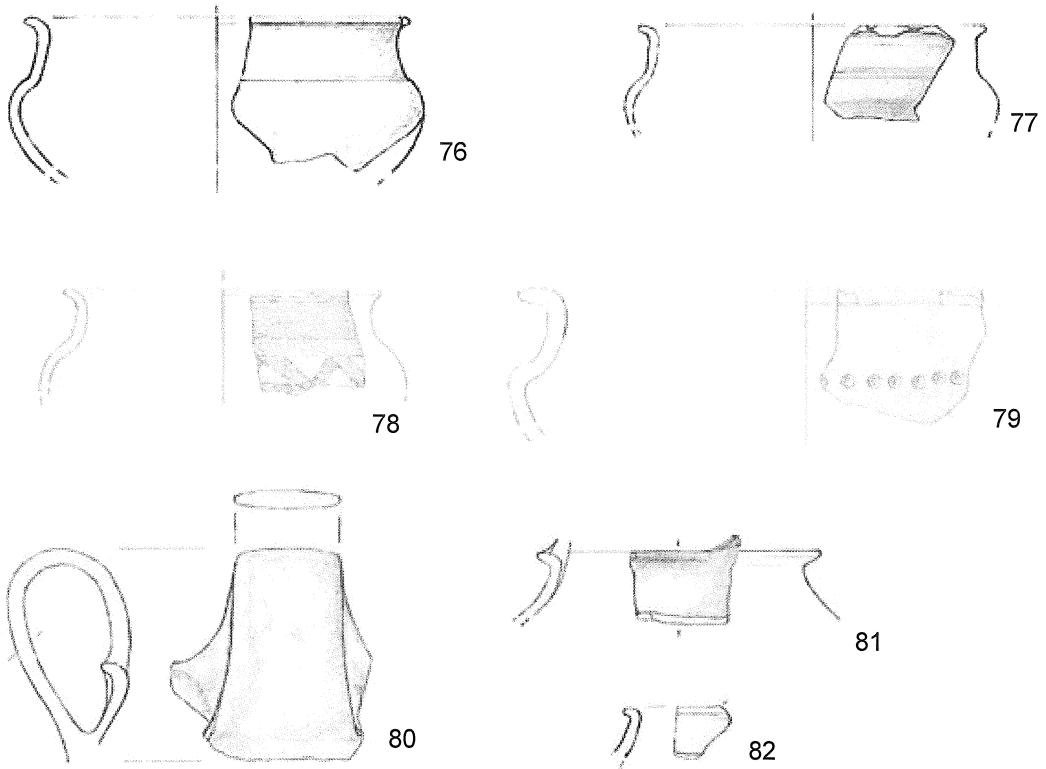

Tazze 3.3.b

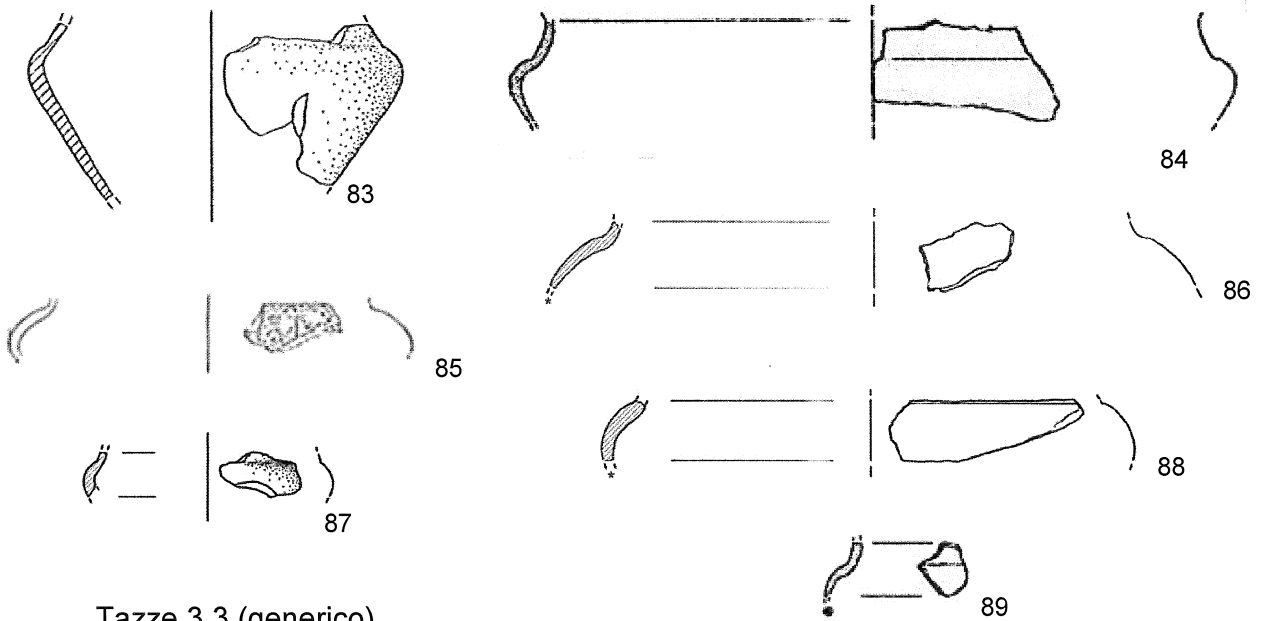

Tazze 3.3 (generico)

TAV. 7



Tazze 4.1

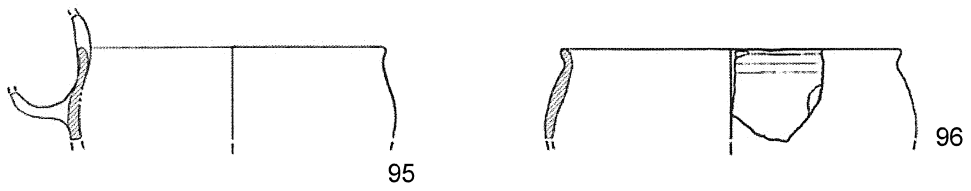
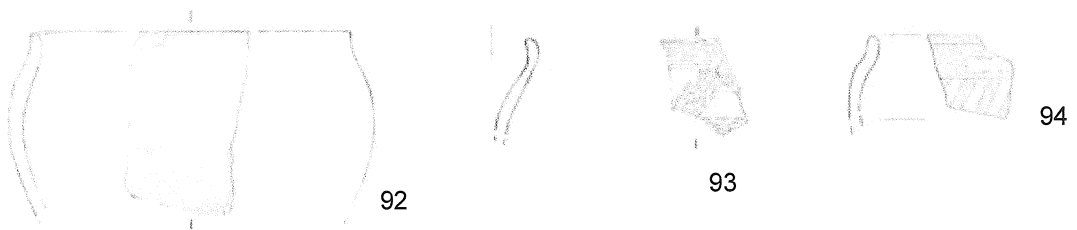

Tazze 4.2

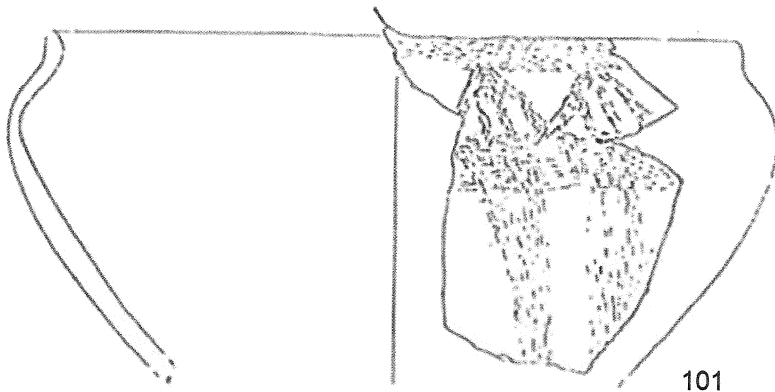

101

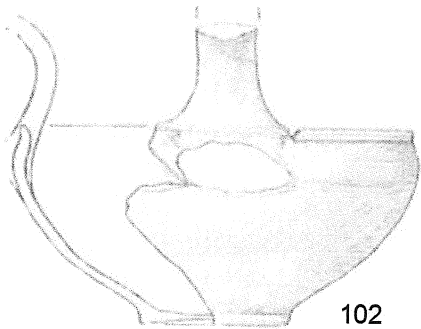

102



103

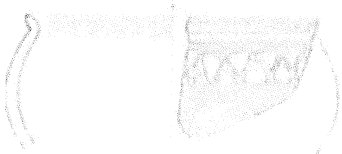

104

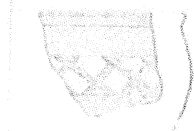

105

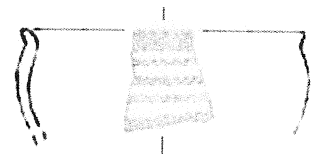

106



107



108



109



110

Tazze 4.3.a

TAV. 9

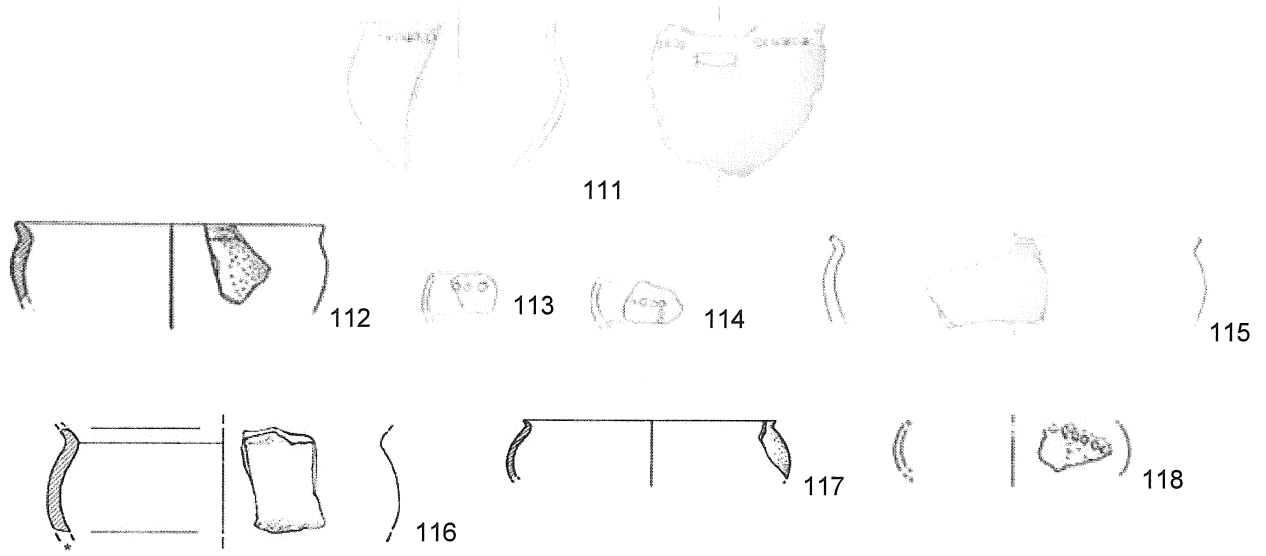

Tazze 4.3.b

100

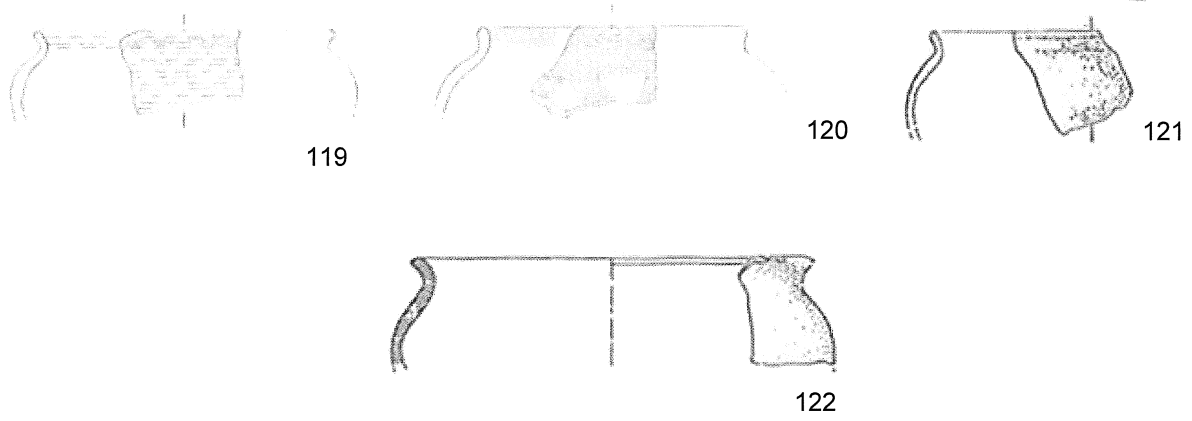

Tazze 4.3.c

TAV. 10

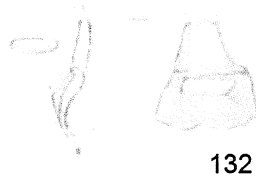
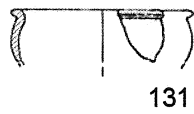
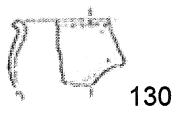
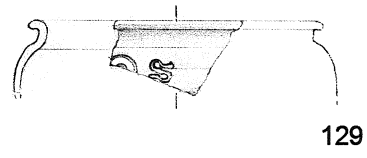
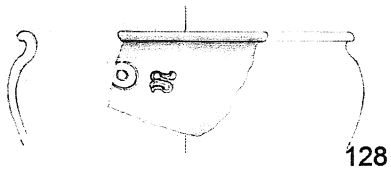
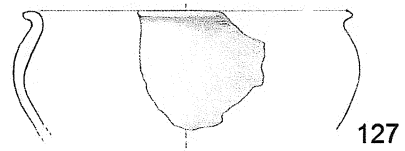
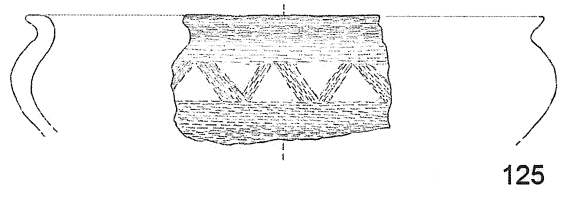
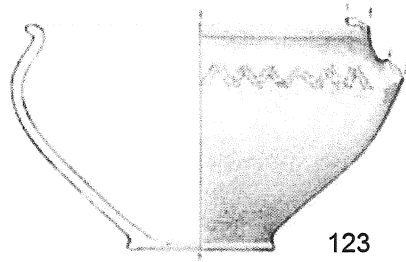

Tazze 4.3.d

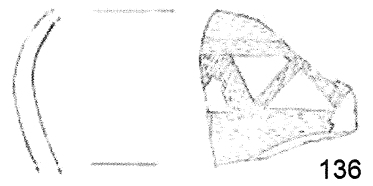
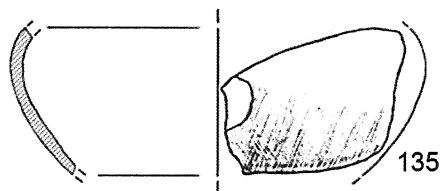

Tazze 4 (generico)



TAV. 11

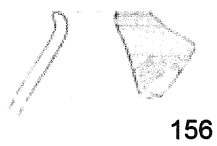
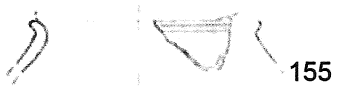
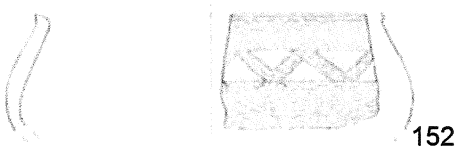
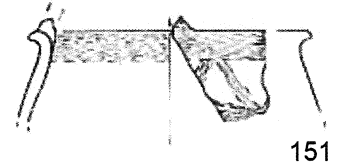
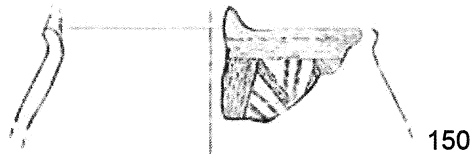
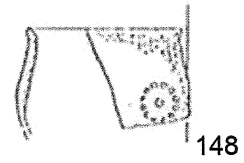
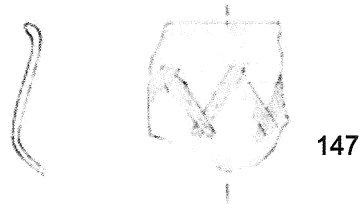
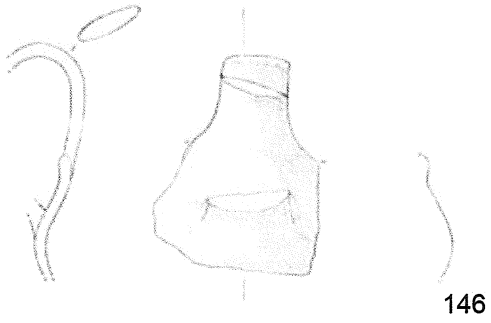
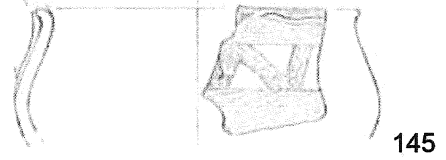
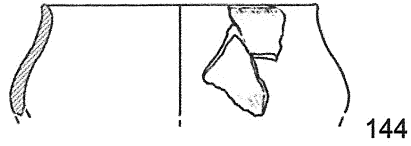
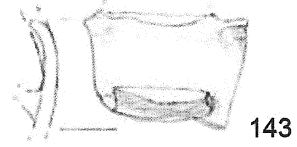
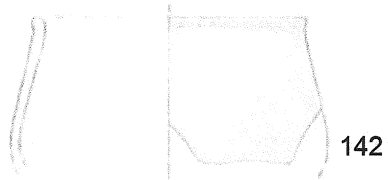
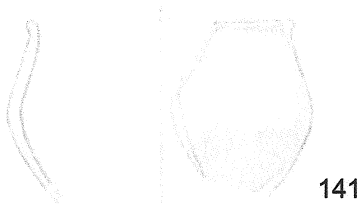
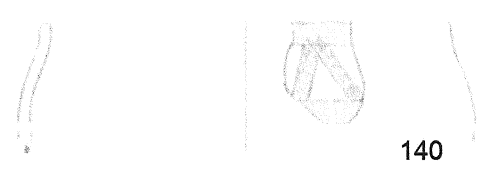
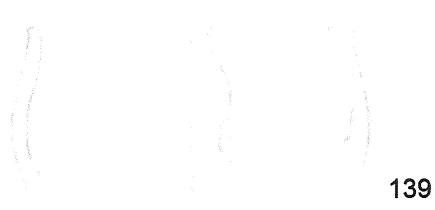

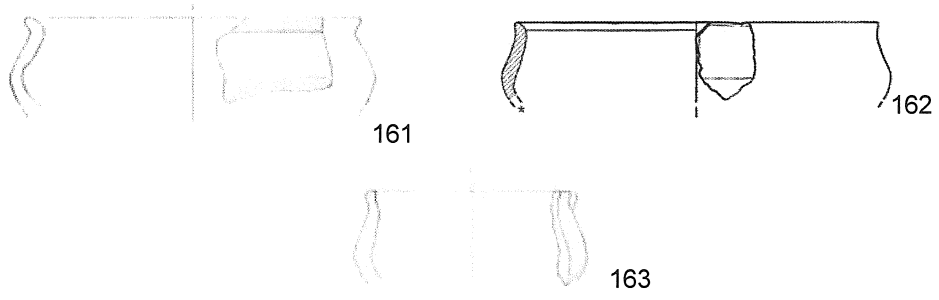

Tazze 5.2

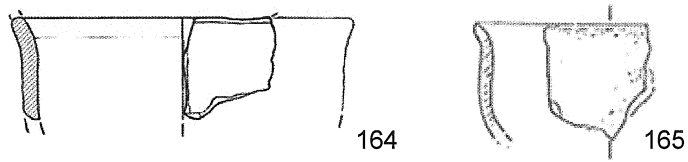

Tazze 5.3

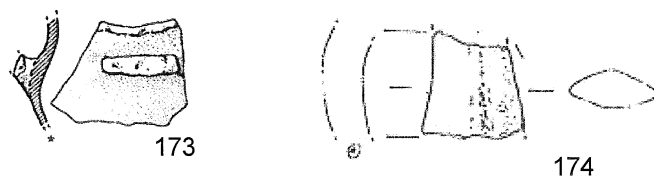
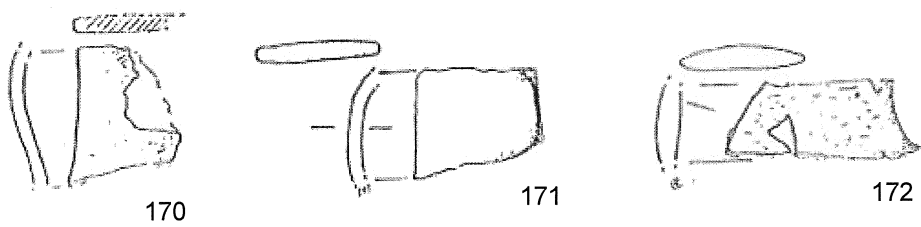
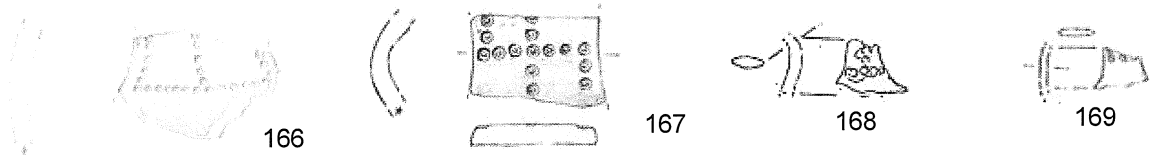

Anse di tazza

TAV. 13

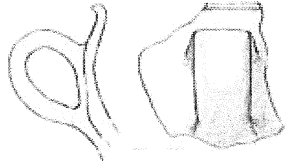

175

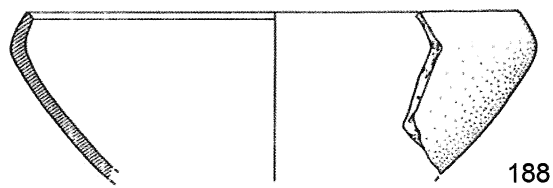
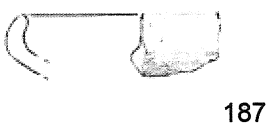
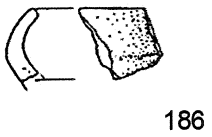
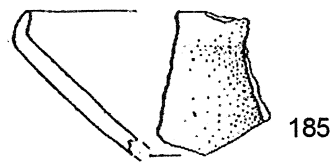
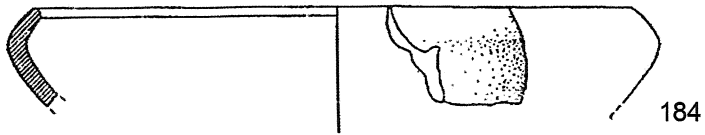
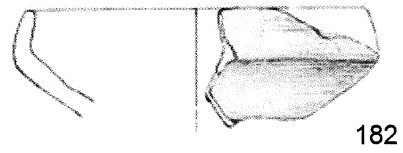
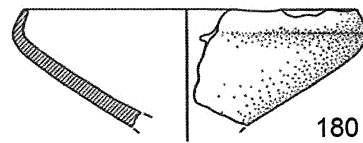
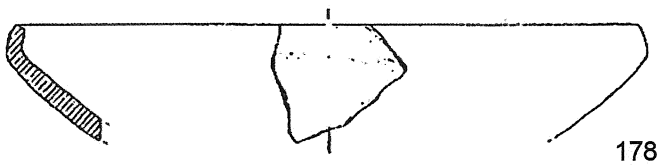
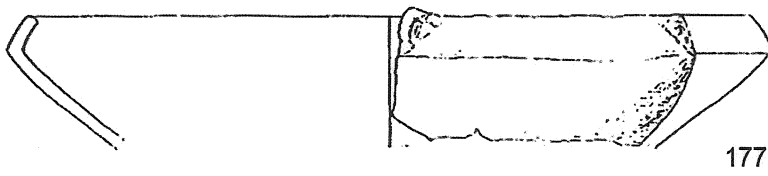
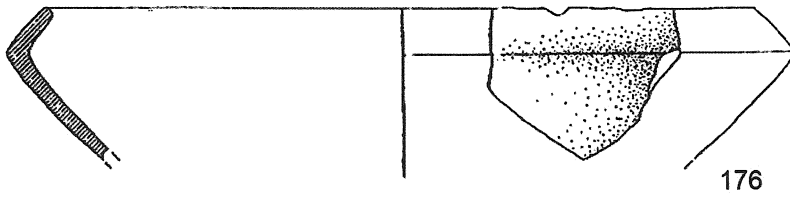

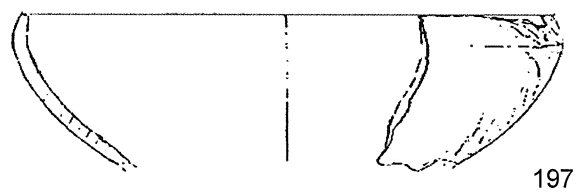
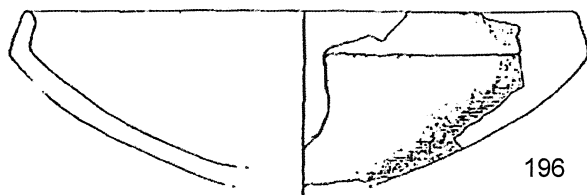
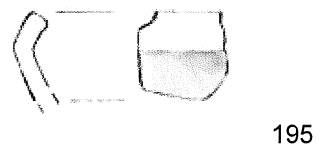
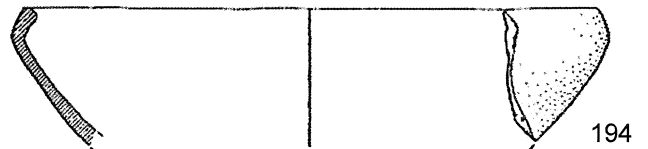
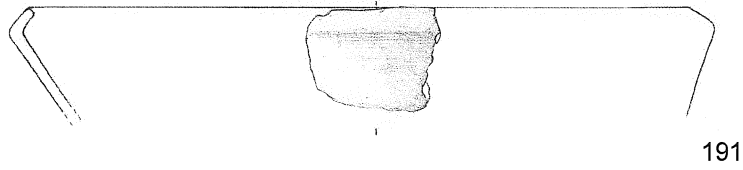
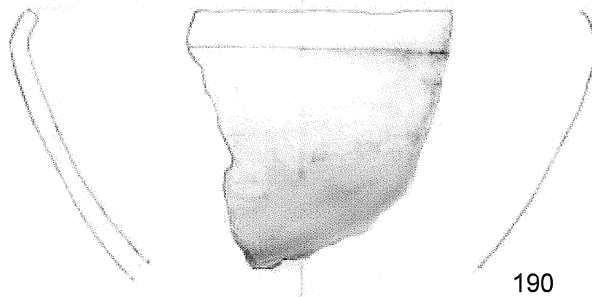
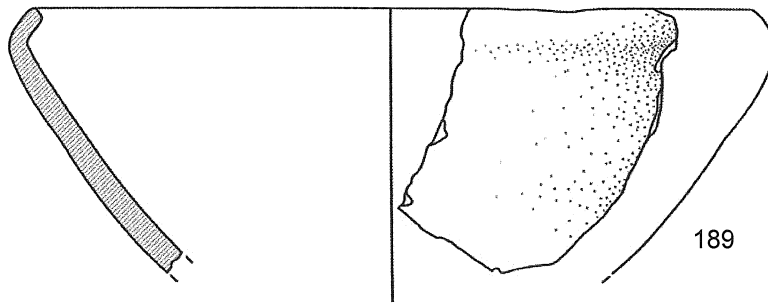

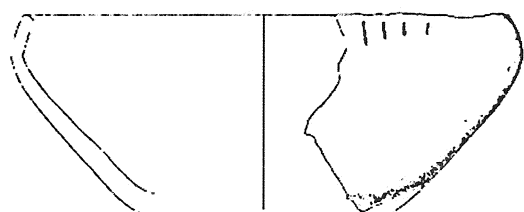

198

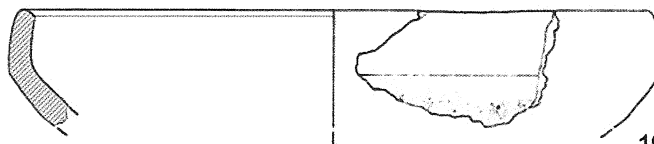

199

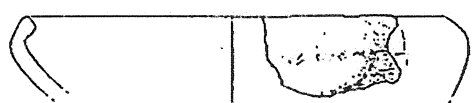

200



201



202

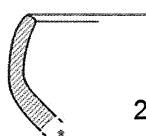

203

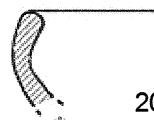

204

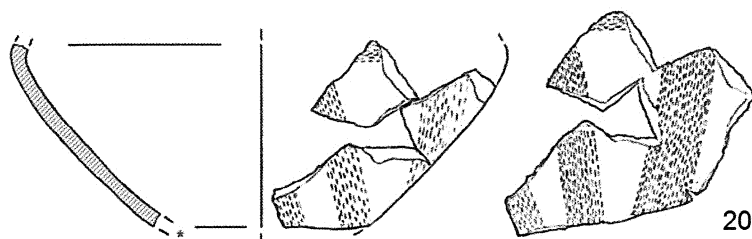

205

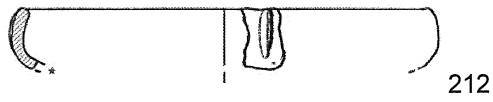
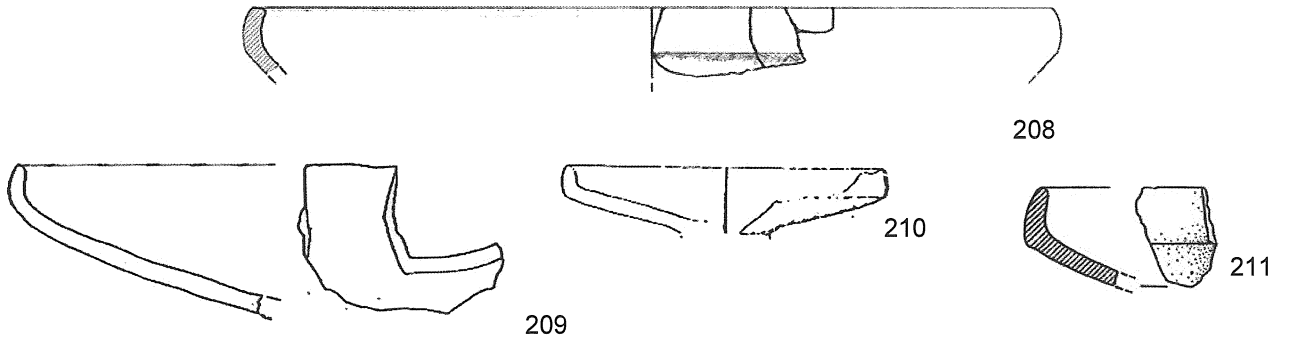
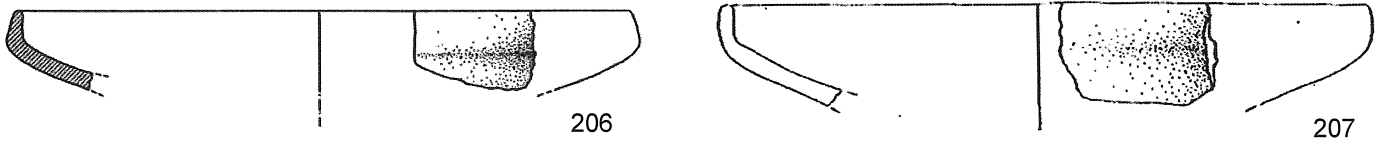

Variante

Coppe 1.3



Coppe 1.4

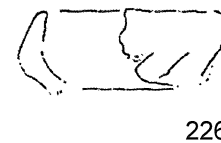
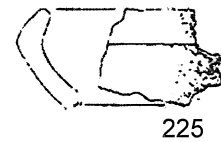
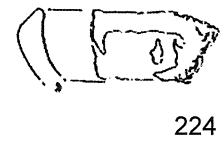
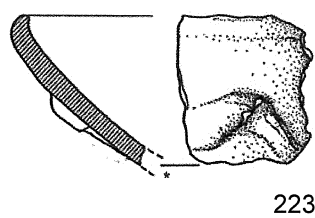
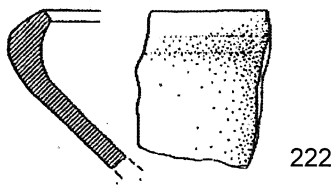
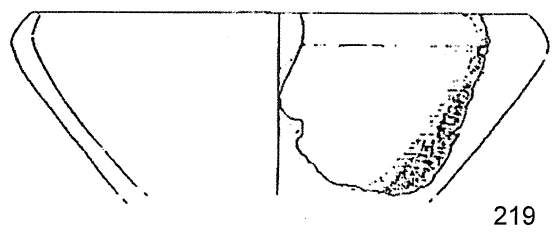
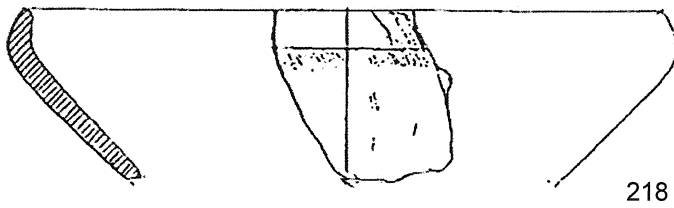
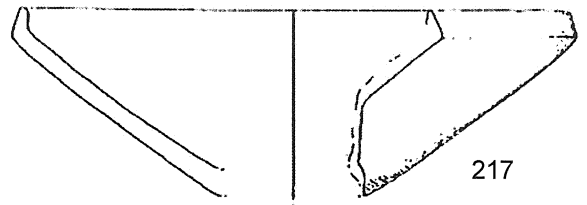
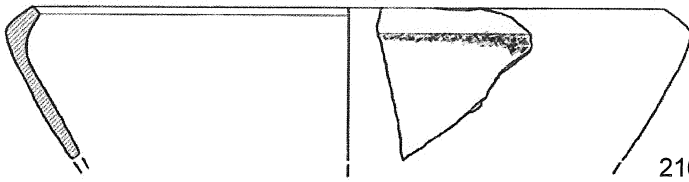
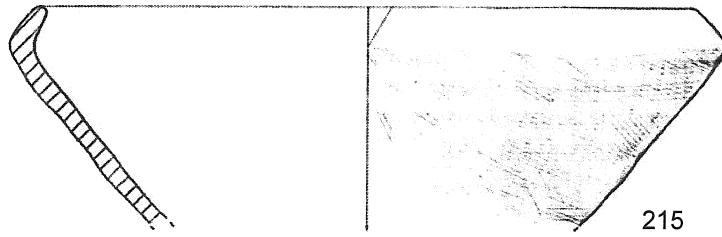
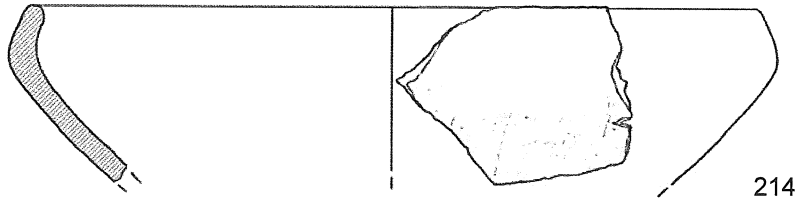

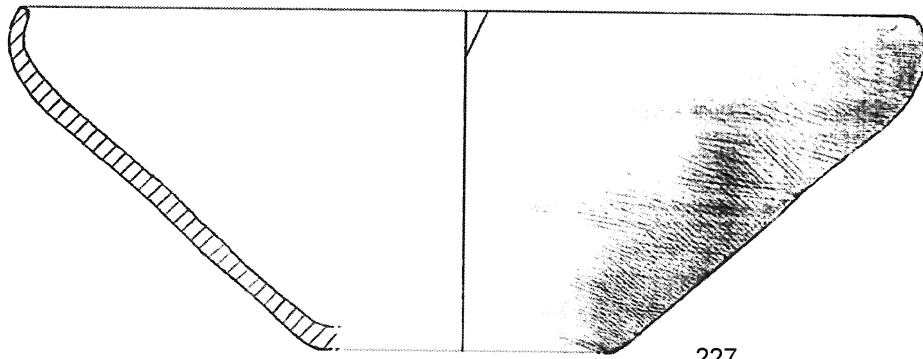

227

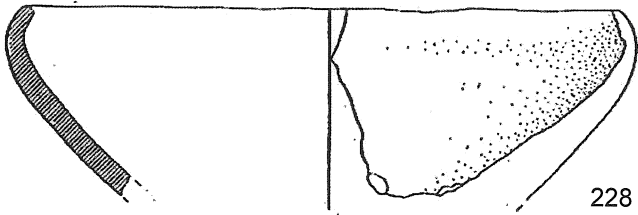

228

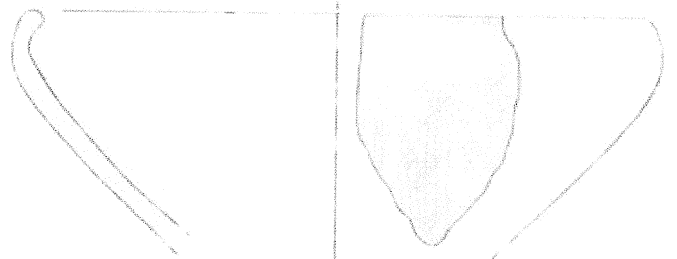

229

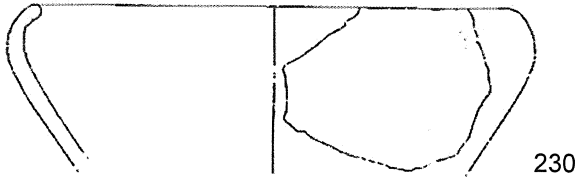

230

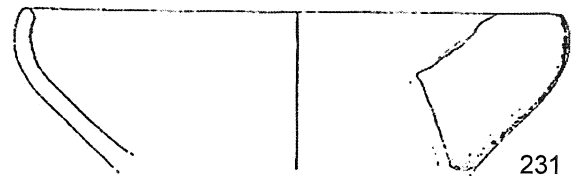

231



232

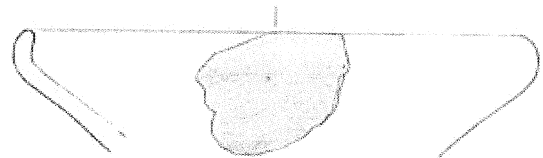

233

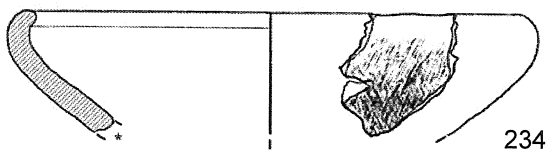

234

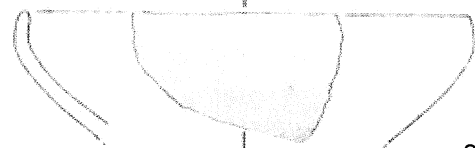

235



236



237

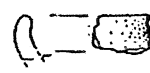

238

Coppe 2.1.a

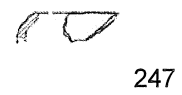
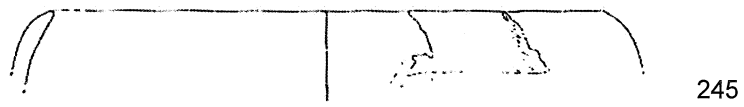
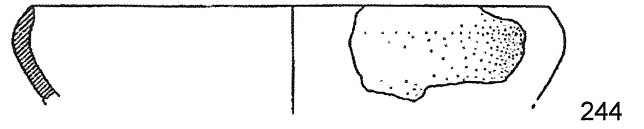
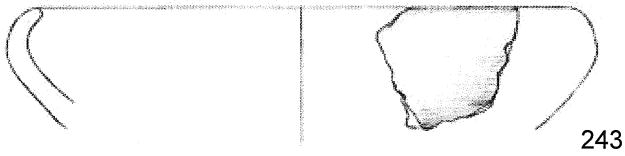
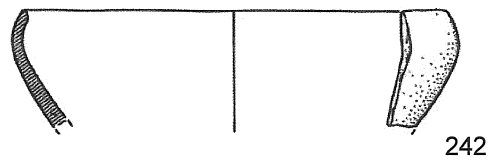
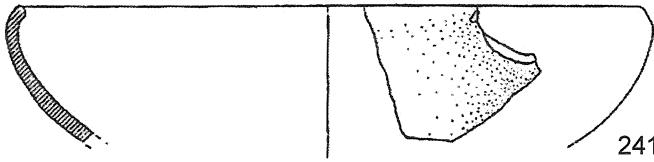
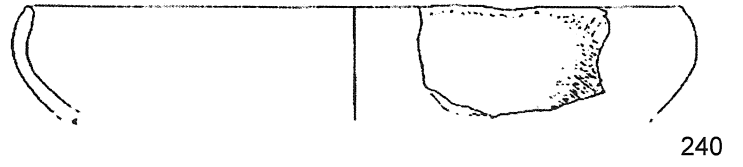
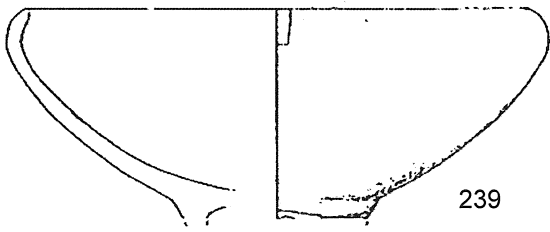

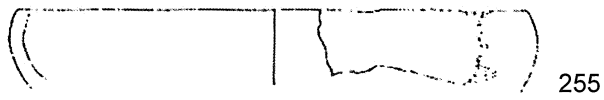
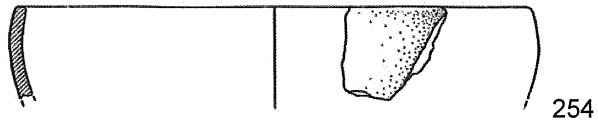
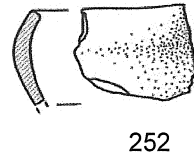
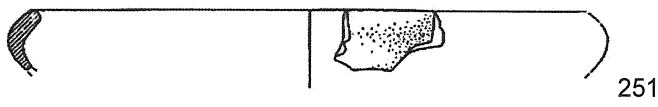
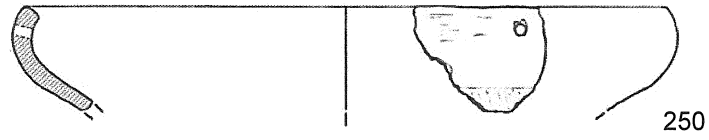
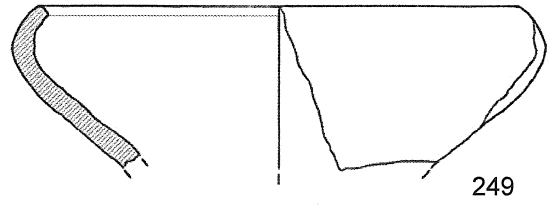
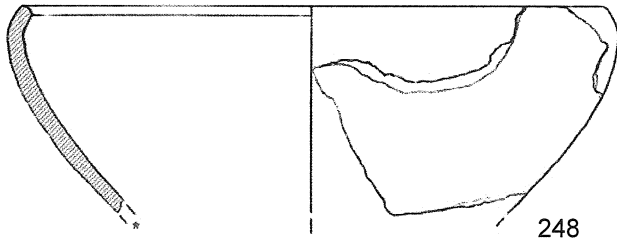

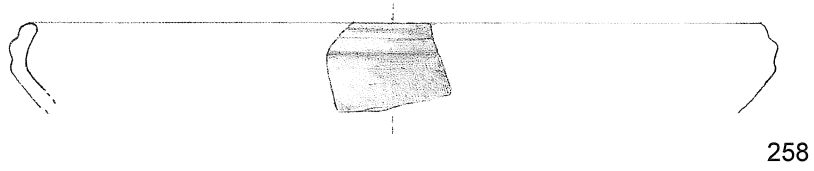
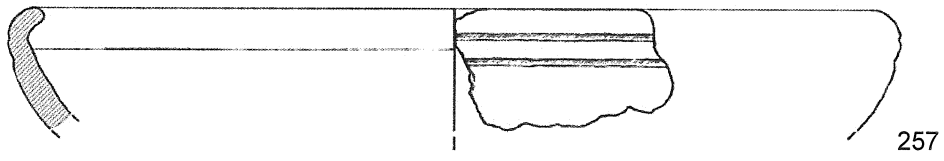

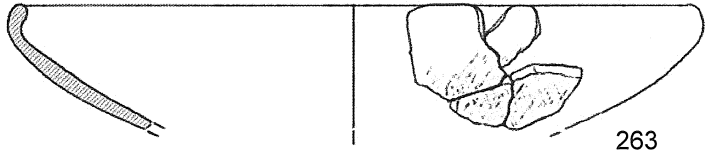

263

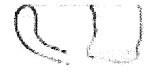

265

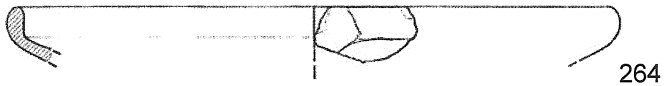

264

Coppe 2.2.b

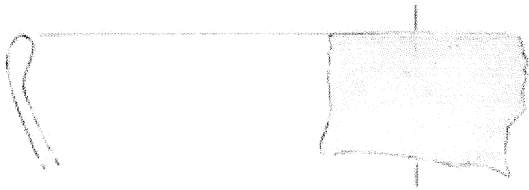

266



267



268

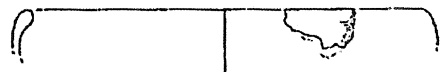

269

Coppe 2.2.c

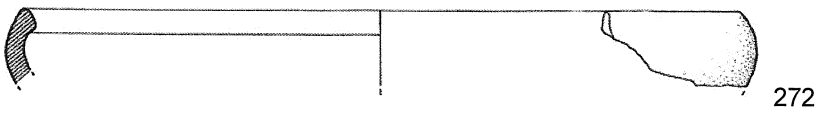
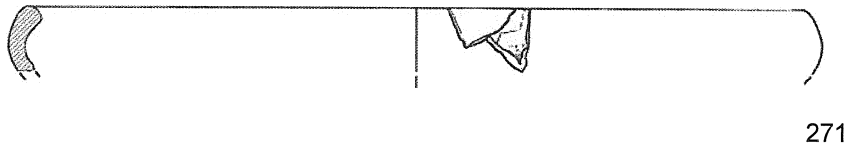
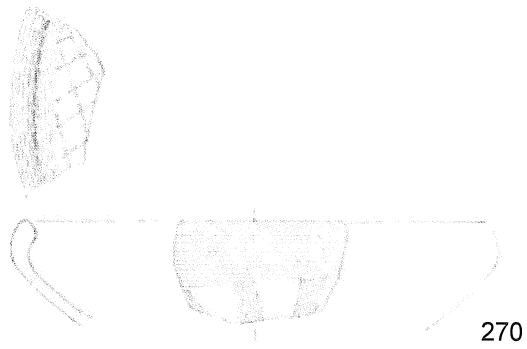



275



277

278

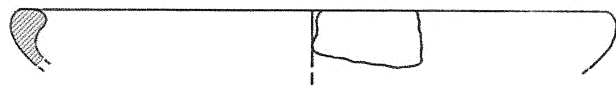

279

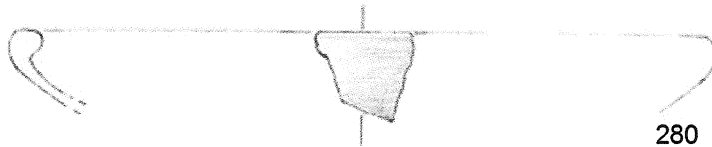

280

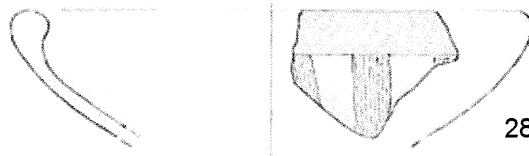

281

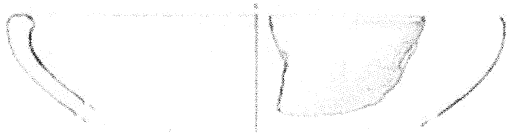

282



283

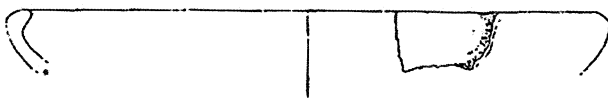

284



285



286



287

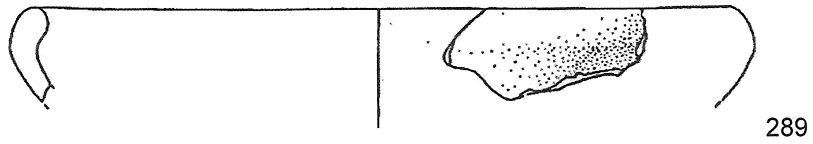
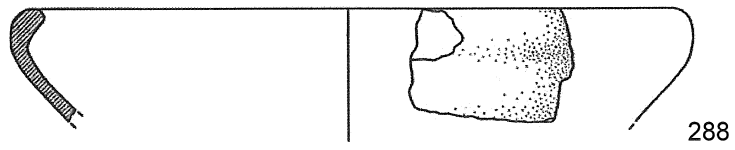

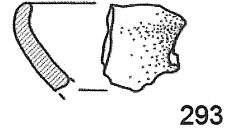
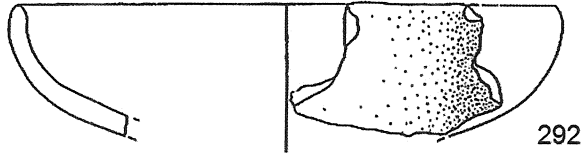

Coppe 2.3.a

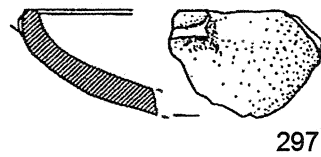
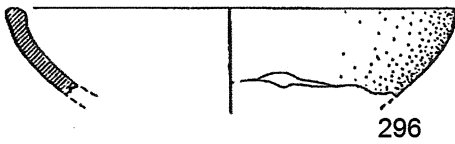
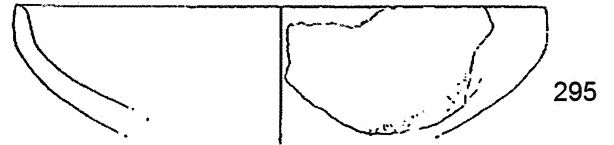
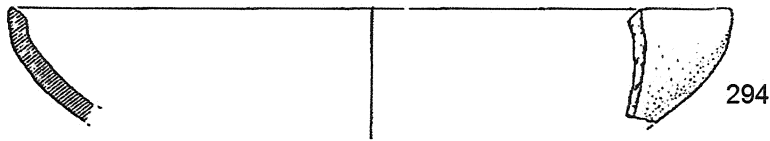

Coppe 2.3.b

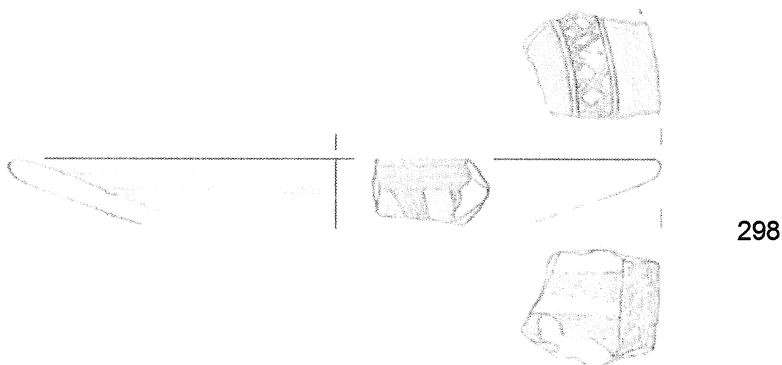

Coppe 3.1

TAV. 28

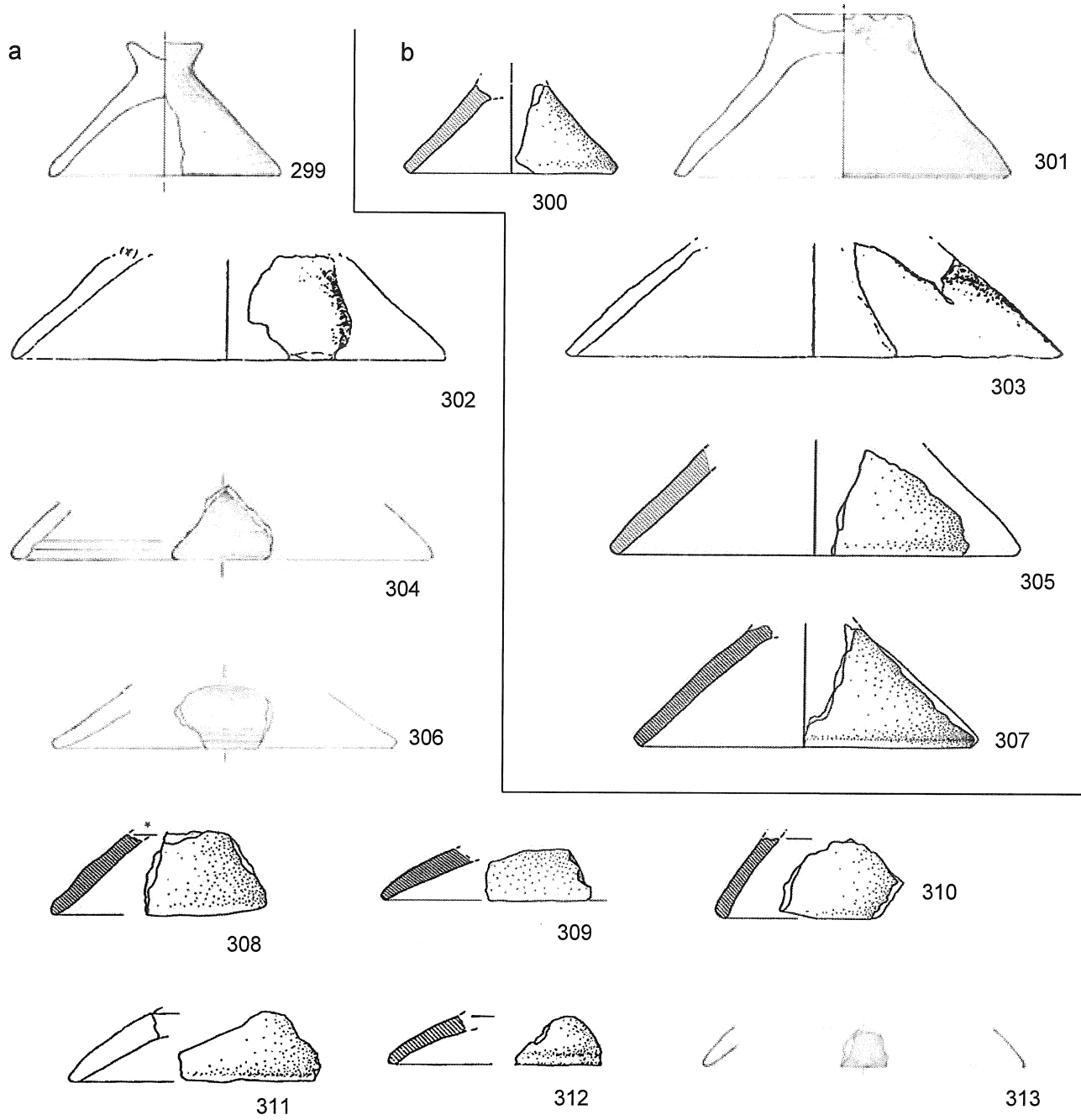

Coppe-coperchio 1.1 a, b



Variante

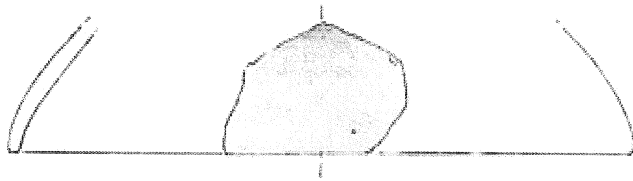

315

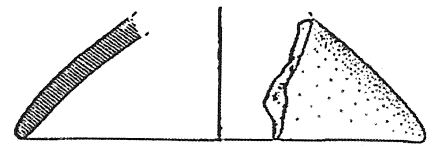

316

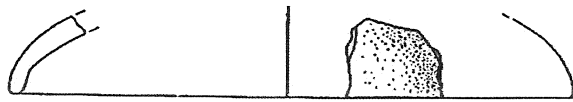

317



318

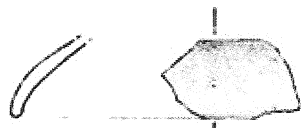

319

Coppe-coperchio 1.2.a

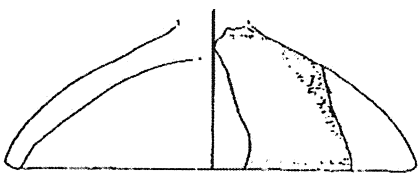

320

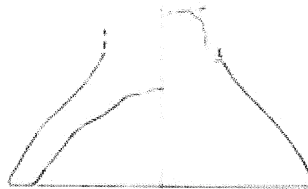

321

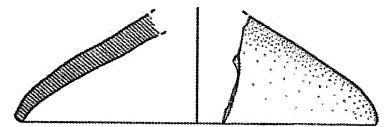

322



323

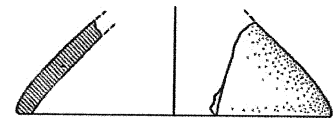

324



325

Coppe-coperchio 1.2.b

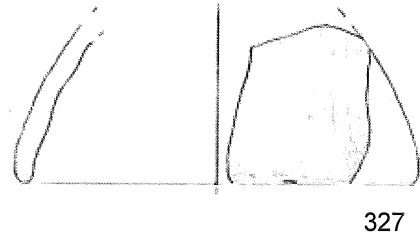
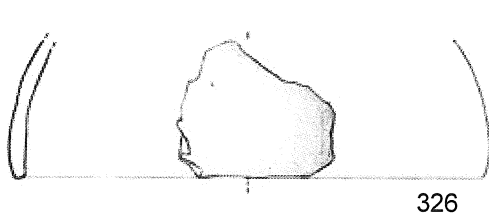

Coppe-coperchio 2.1.a

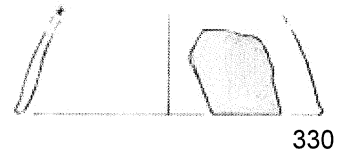
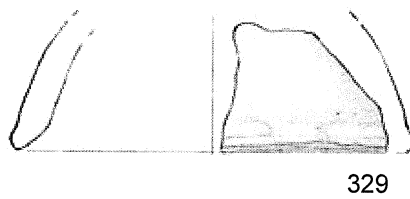
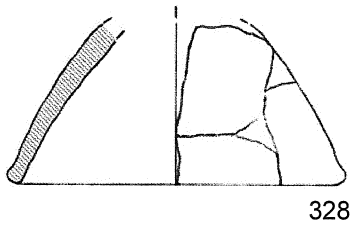

Coppe-coperchio 2.1.b

TAV. 31

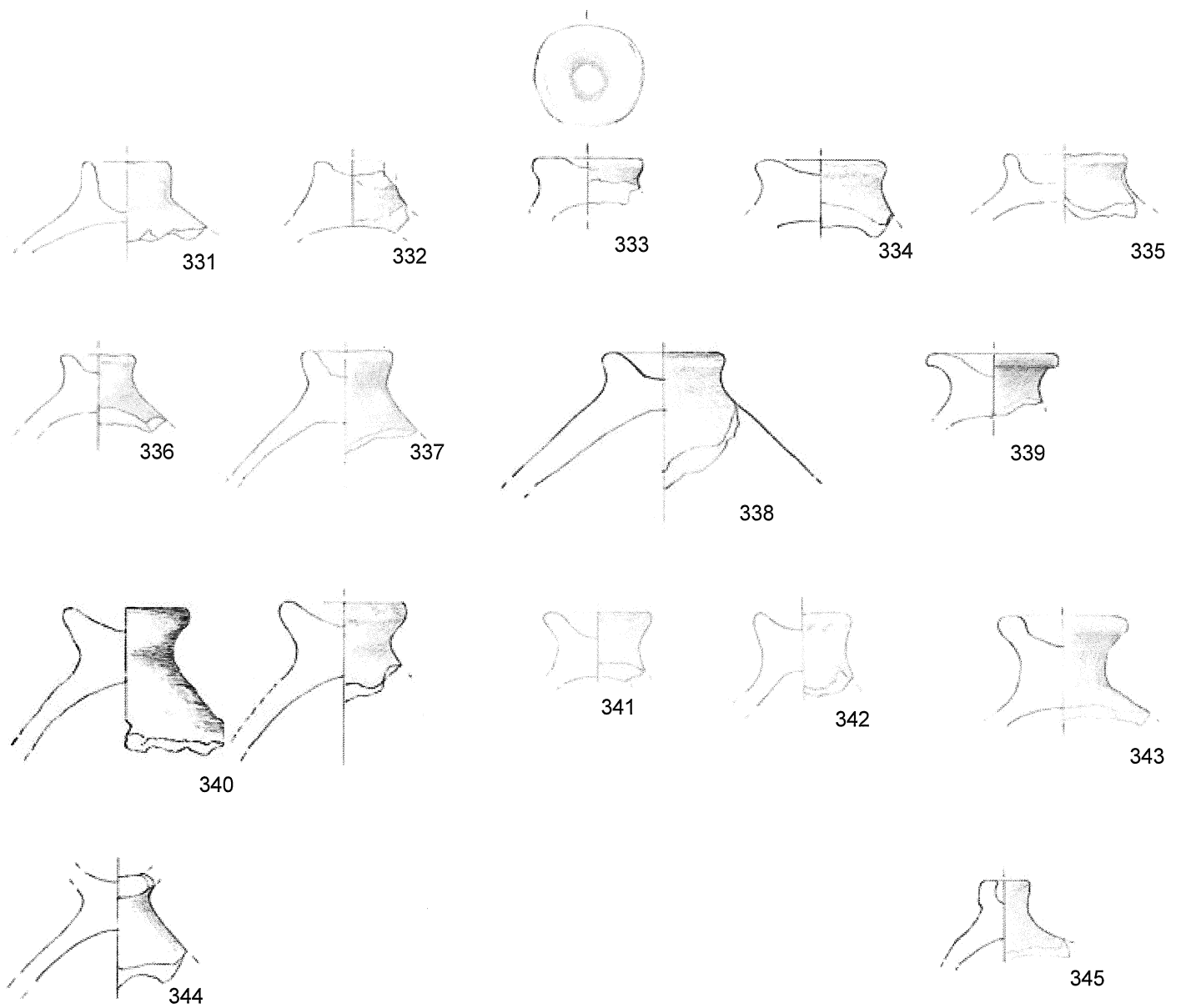

Campionatura di prese di coperchio

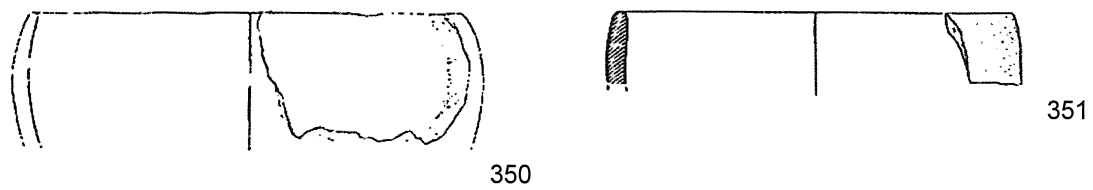
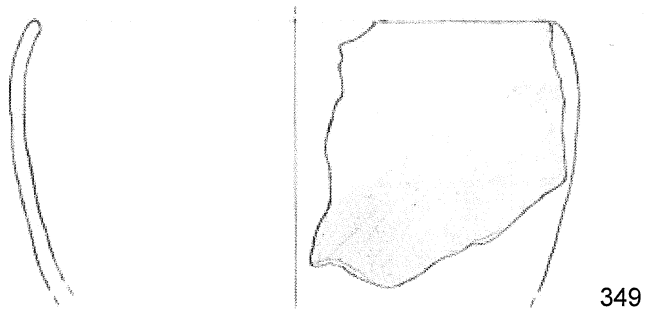
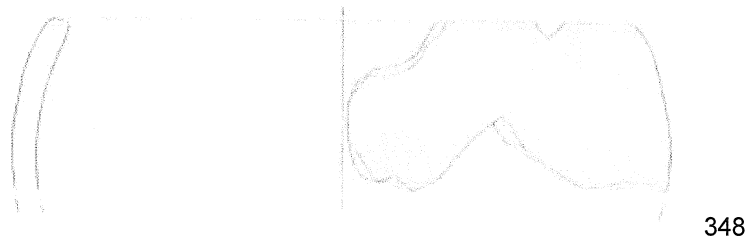
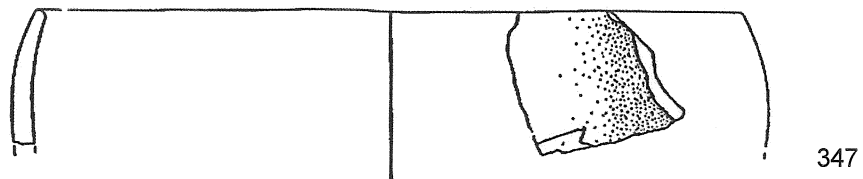
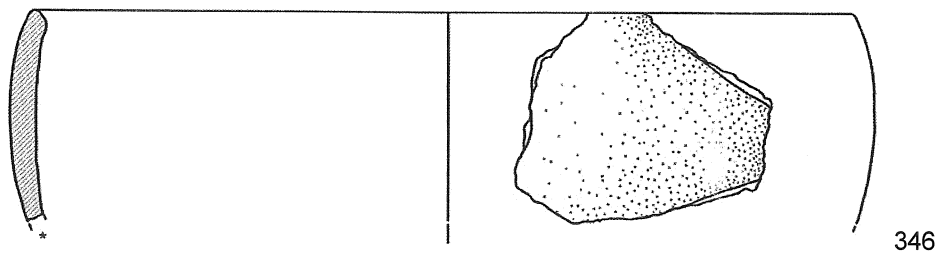

TAV. 33

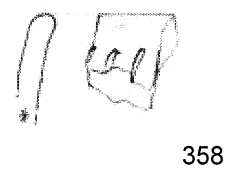
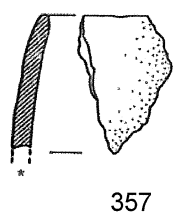
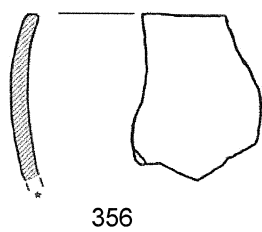
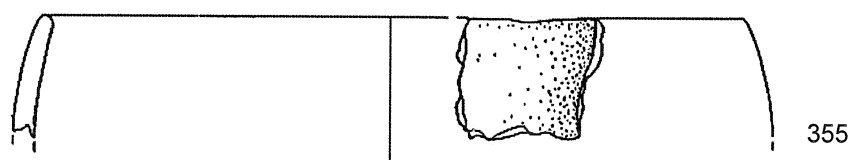
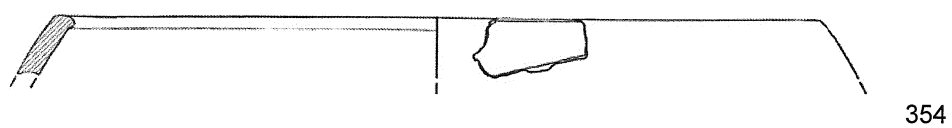
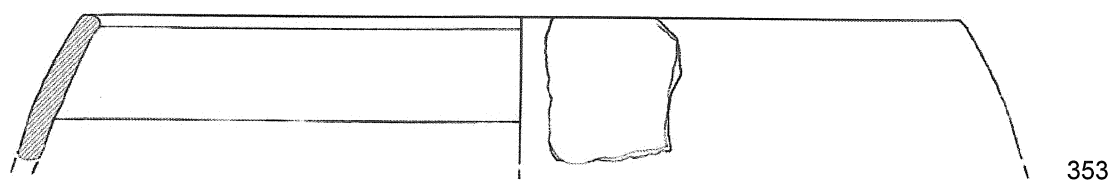
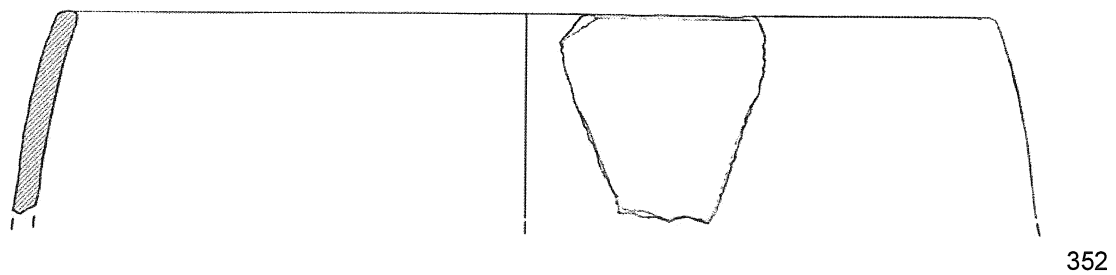

TAV. 34

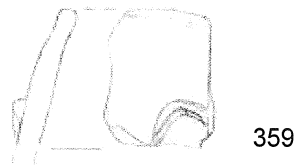

359



360

Scodelloni 1.1.b

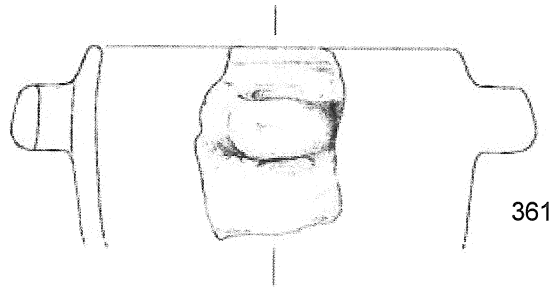

361

Scoelloni 1.1.c

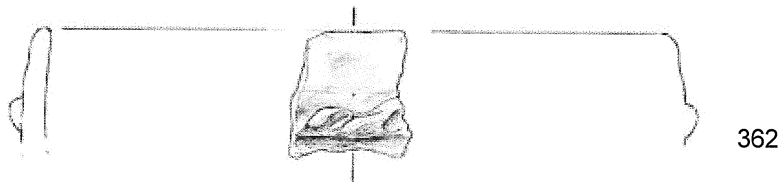

362



363

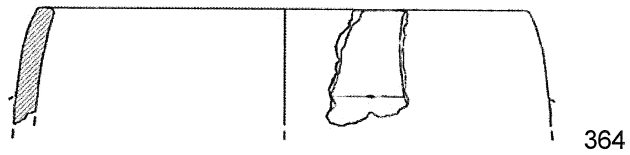

364

Scodelloni 1.1.d

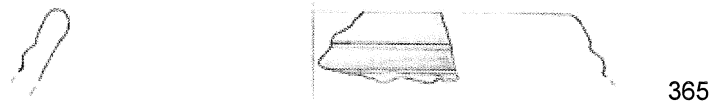

365

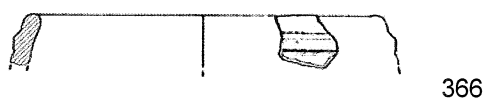

366



367

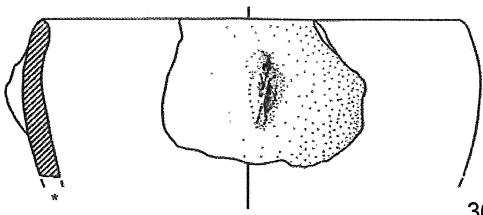

368

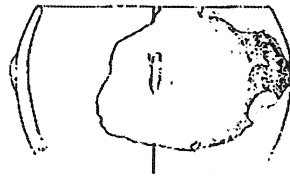

369

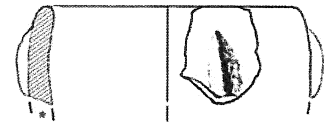

370

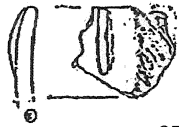

371



372

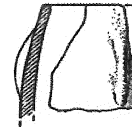

373



374



375

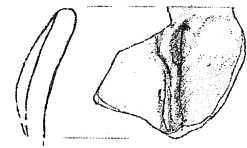

376

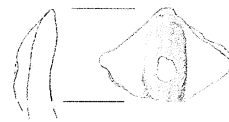

377

Scodelloni 1.2.a



378

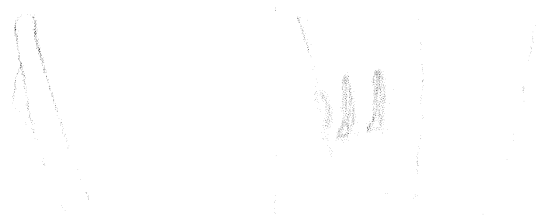

379

Scodelloni 1.2.b

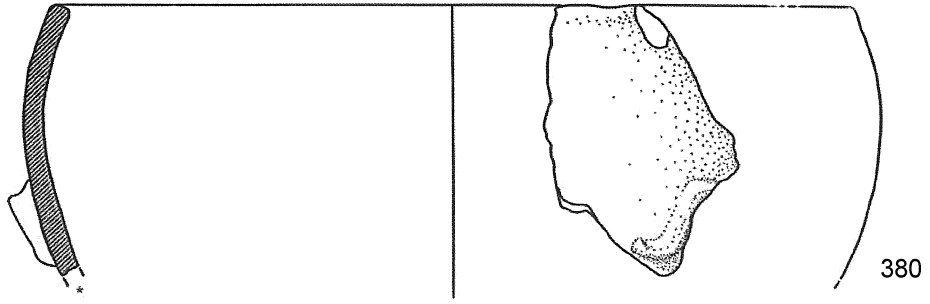

Scodelloni 1.3.a

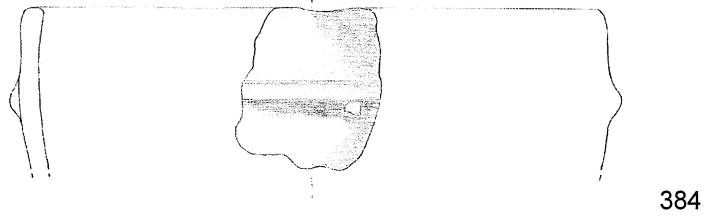
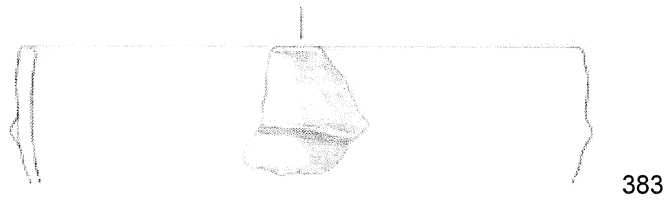
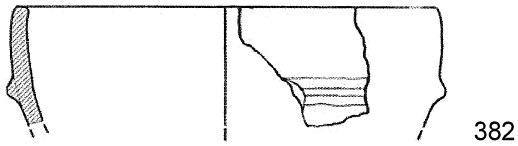
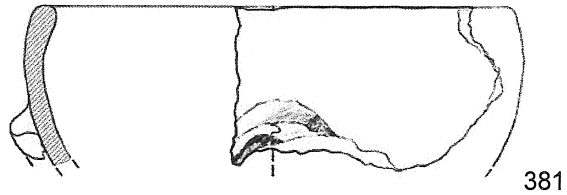

Scodelloni 1.3.b

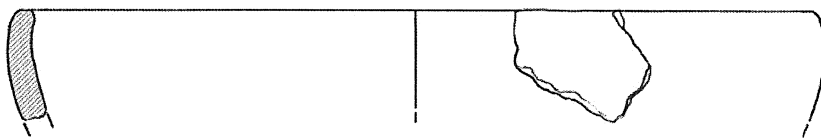

Scodelloni 1.3 generico

TAV. 37

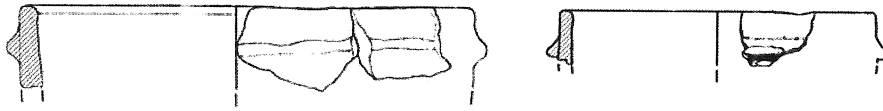

386

387

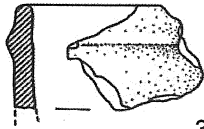

388



389

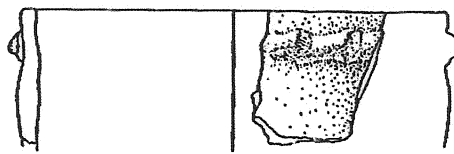

390



391



392



393

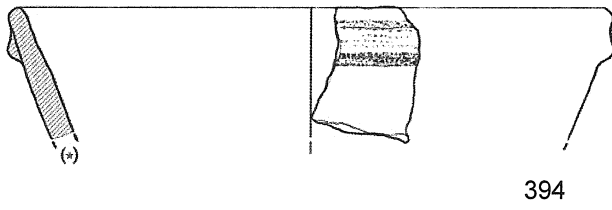

394

395

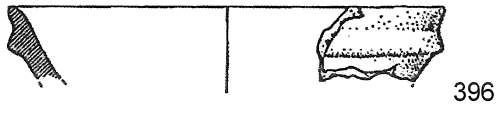

396

397

Scodelloni 2.1.a

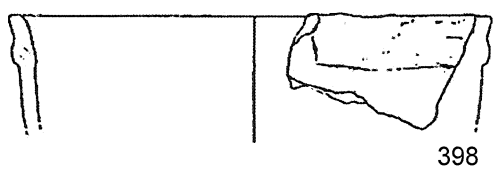

398

399

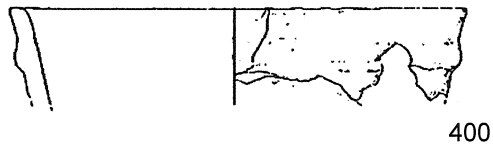

400

401

Scodelloni 2.1.b

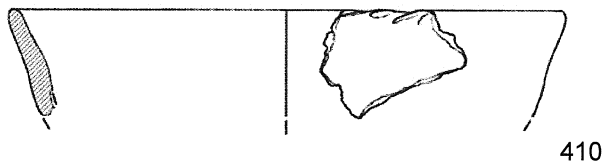
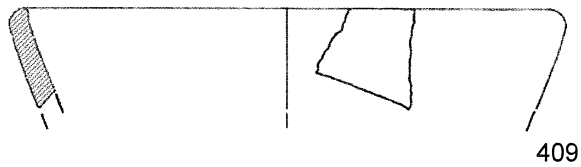
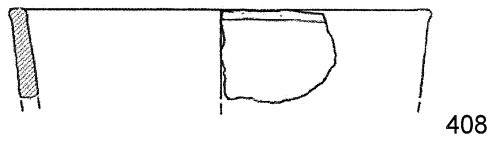
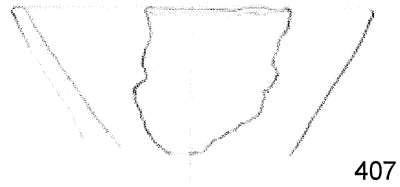
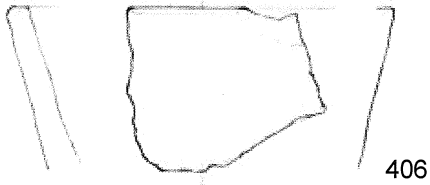
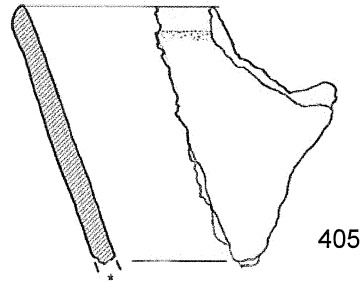
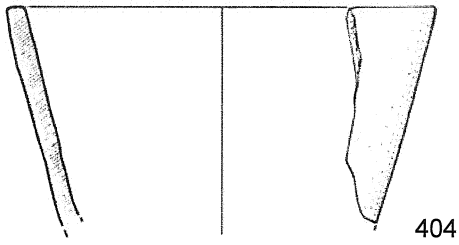
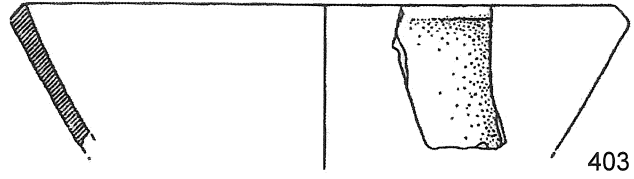
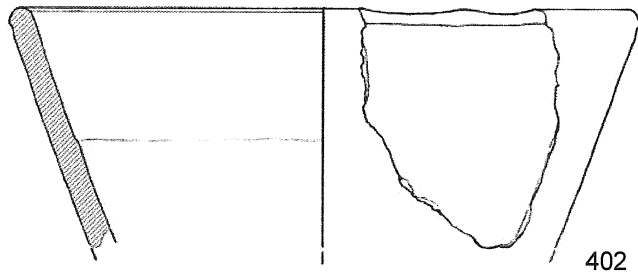

Scodelloni 2.1.c

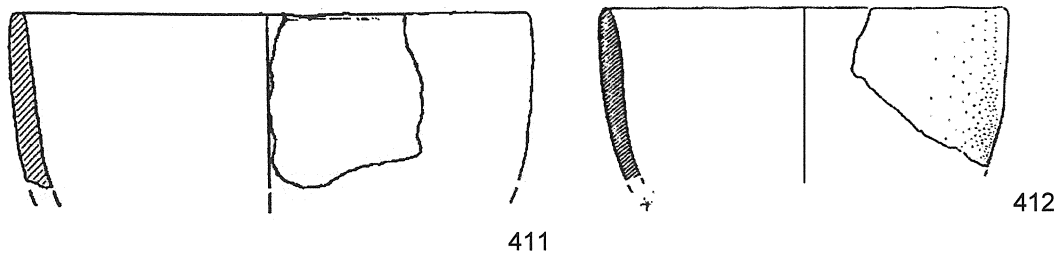

Scodelloni 2.2.a

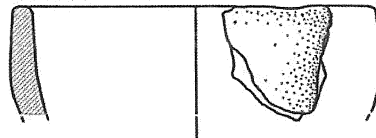

413

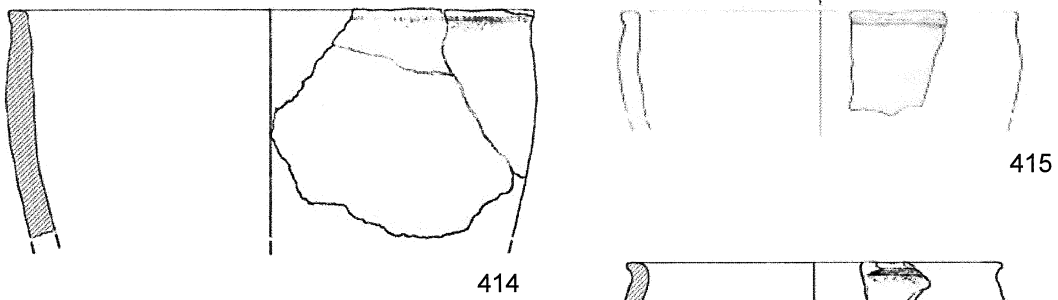

414

415

Scodelloni 2.2.b



416

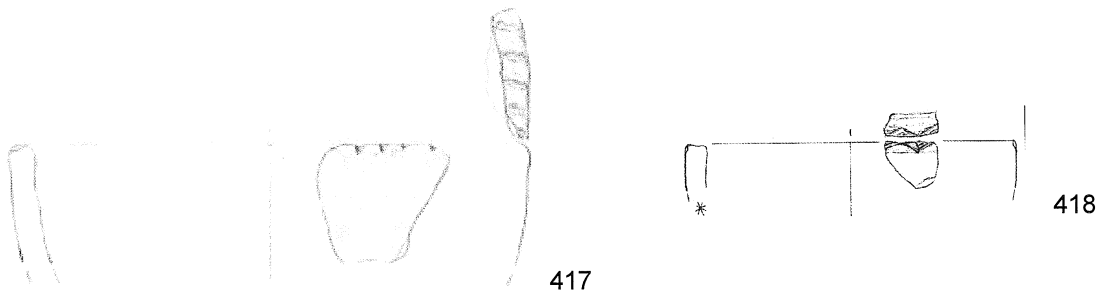

417

418

Scodelloni 2.2.c

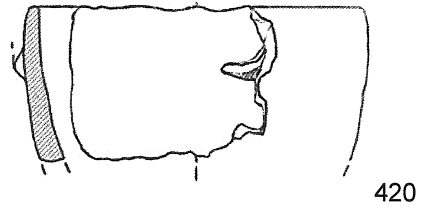
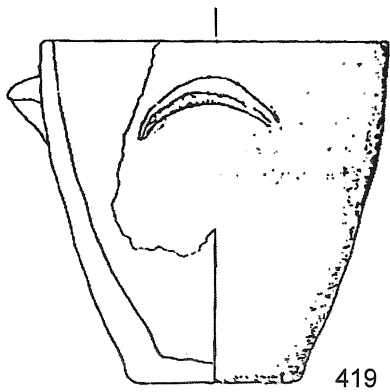

Scodelloni 2.3.a

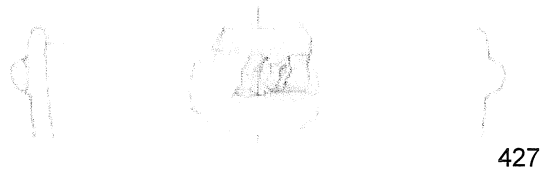
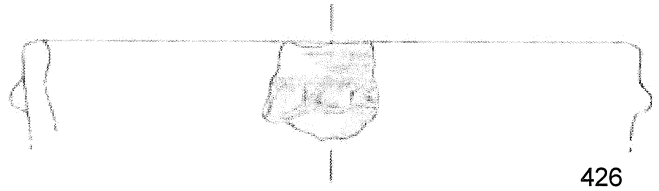
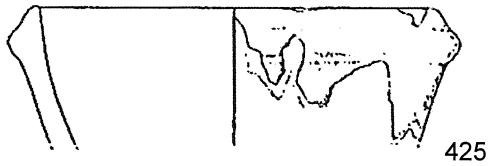
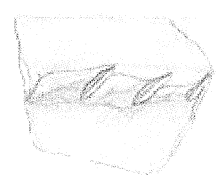
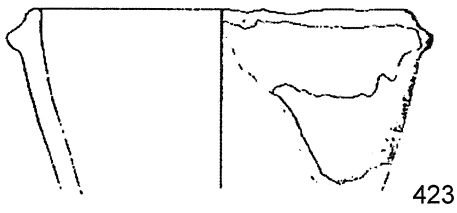
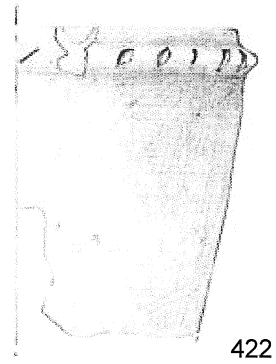
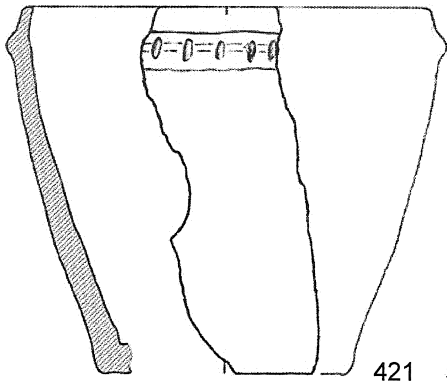

Scodelloni 2.3.b

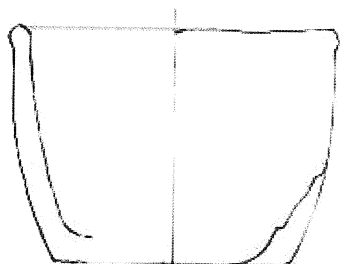

428

Scodelloni 2.4.a

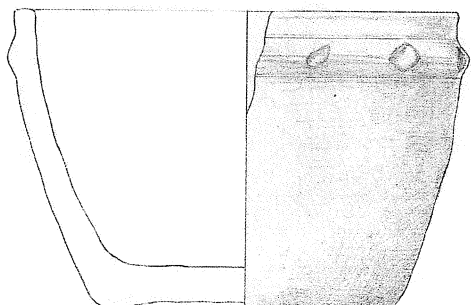

429

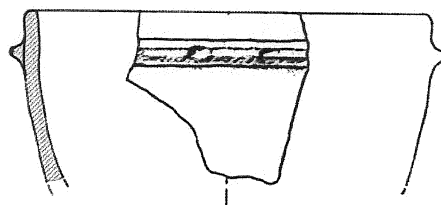

430

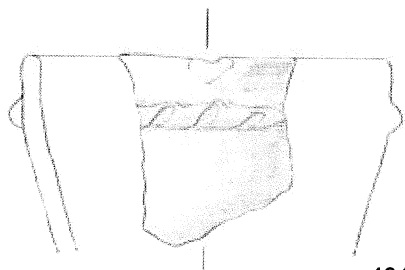

431

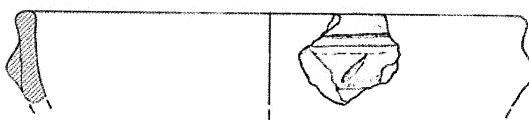

432



433

Scodelloni 2.4.b

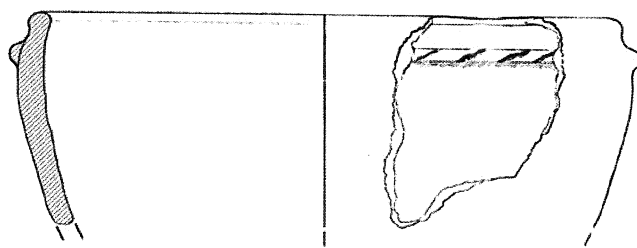

434

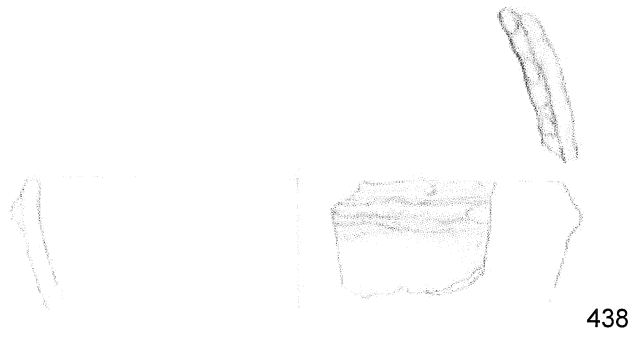
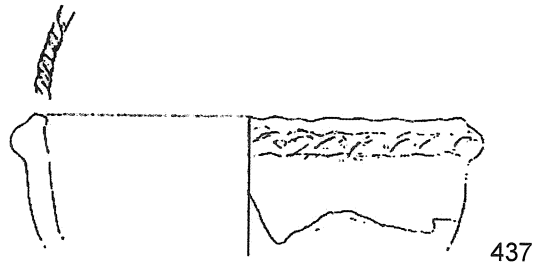

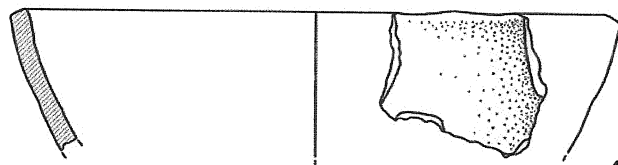
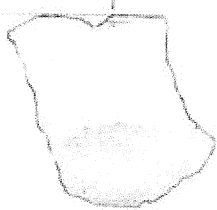
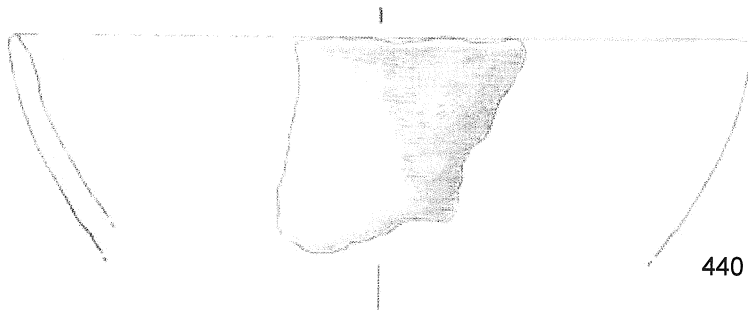

444

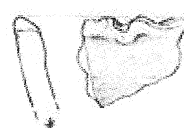
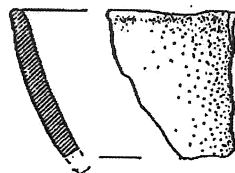

447

Scodelloni 2.5.a

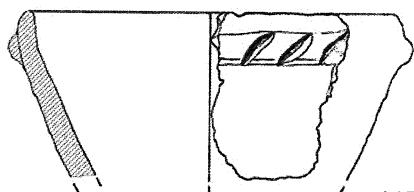

449

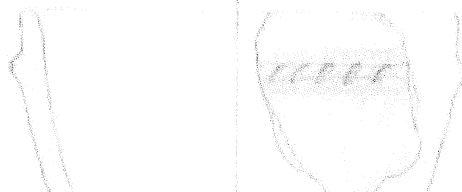

451

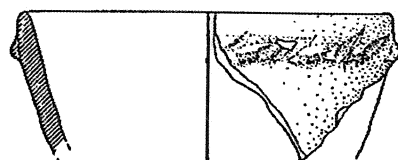

453

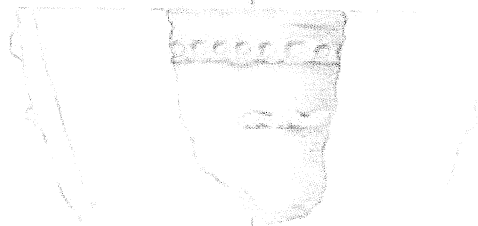

455



457

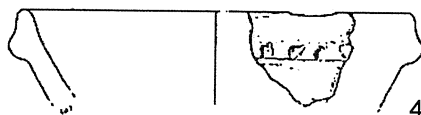

459



461

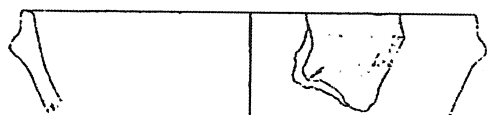

463

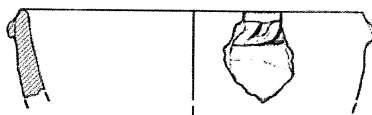

465

Scodelloni 2.5.b

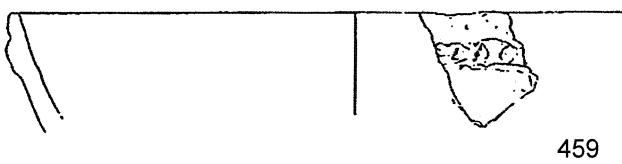
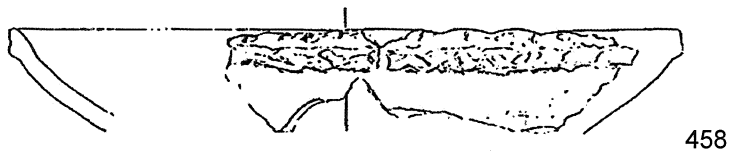
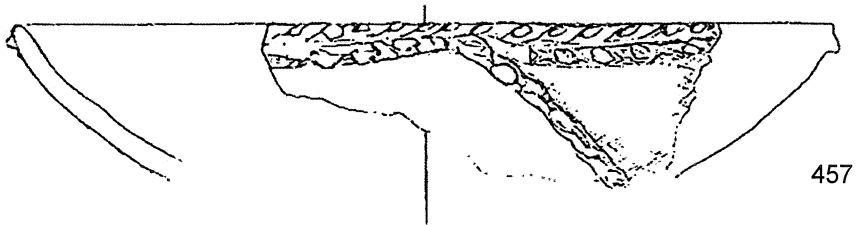
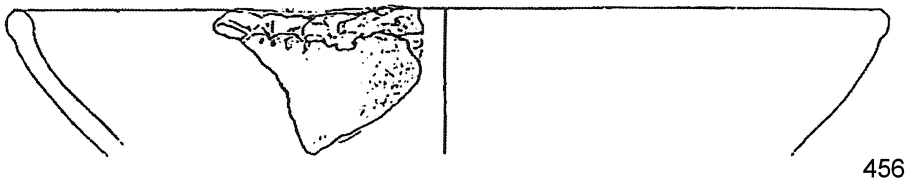
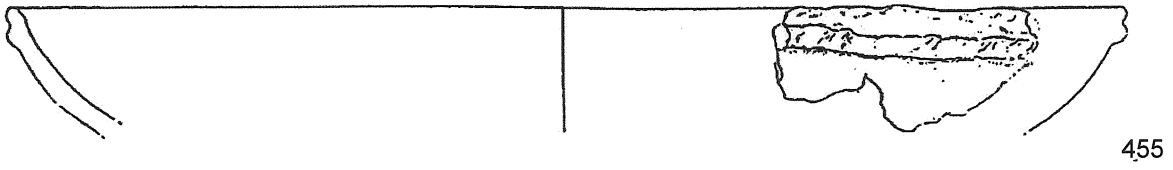
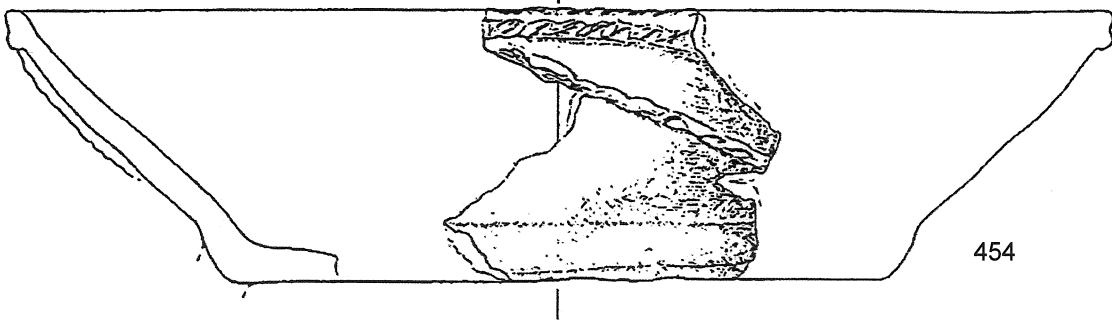

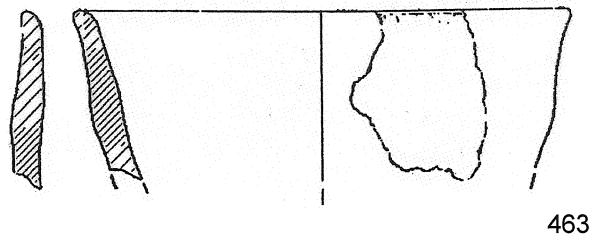
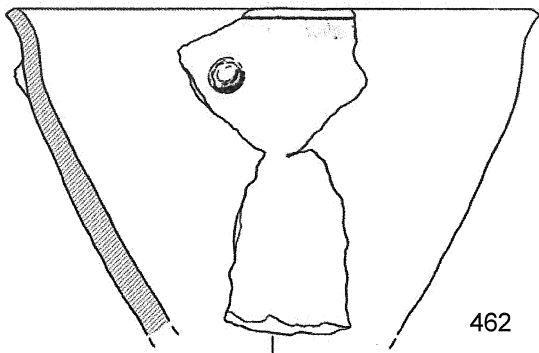
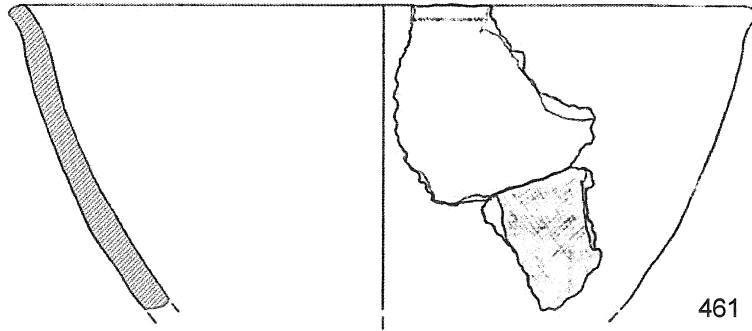

Scodelloni 2.7.a

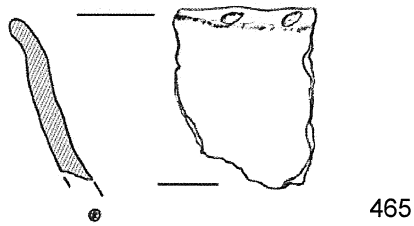
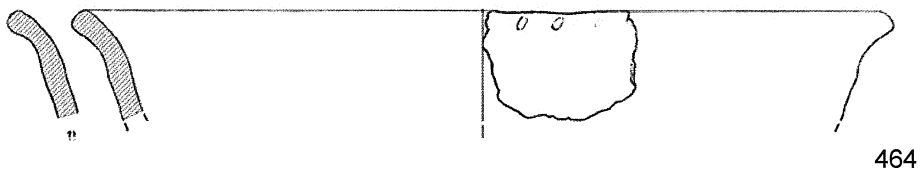

Scodelloni 2.7.b

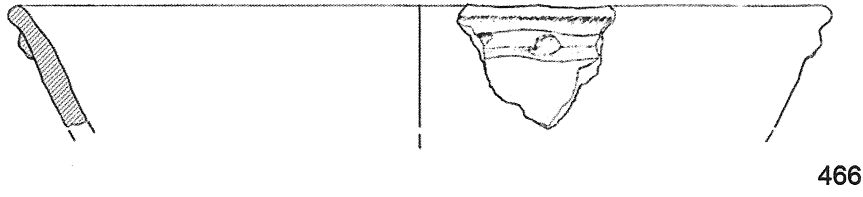

466

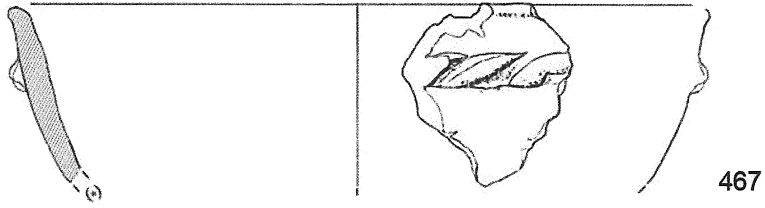

467

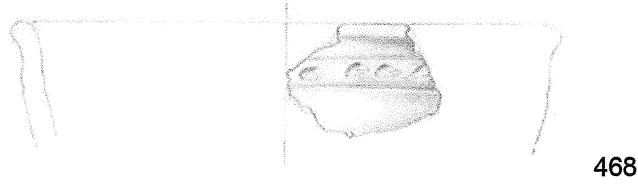

468

Scodelloni 2.7.c

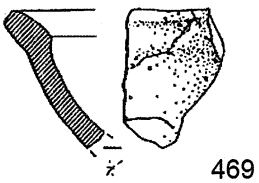

469

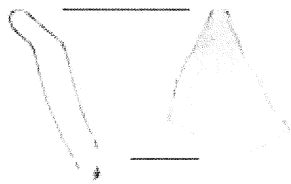

470

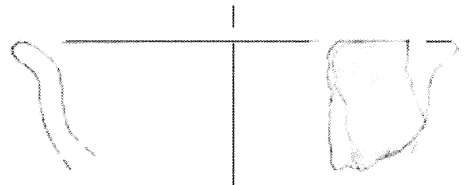

471

Scodelloni 2.7.d

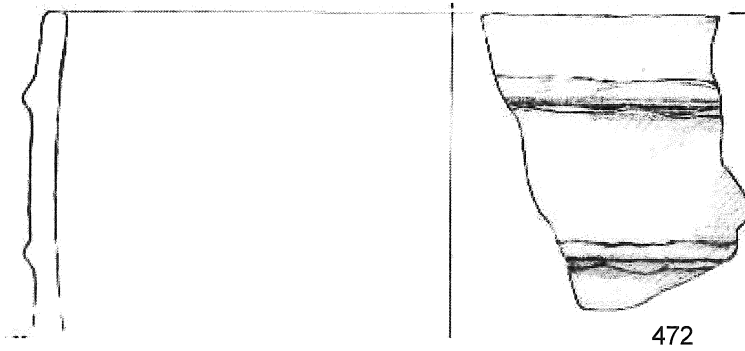

472

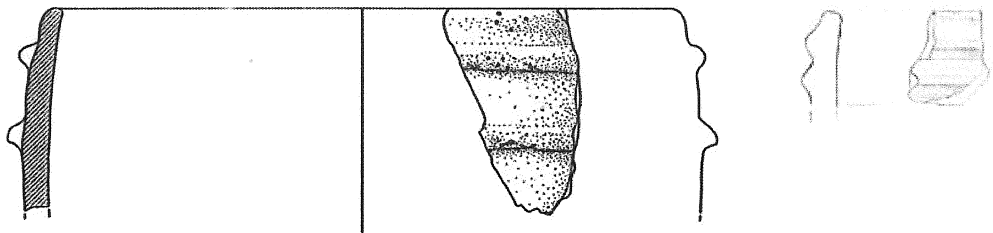

474

Ciste 1.1

473

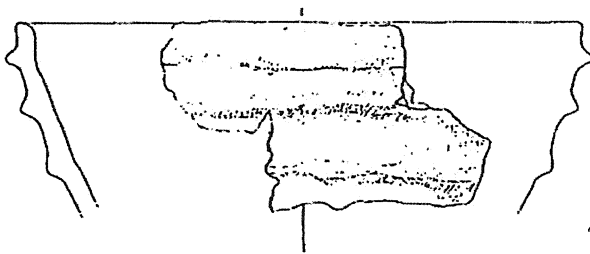

472

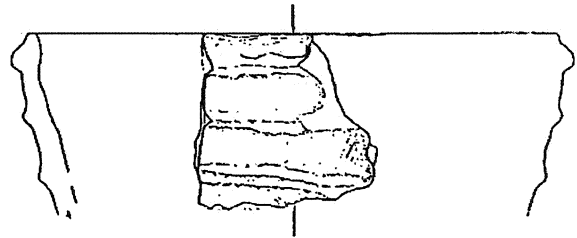

476

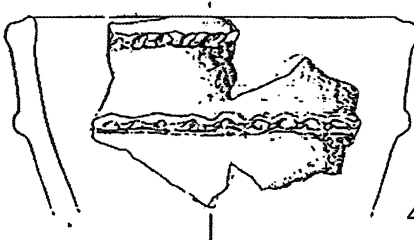

477

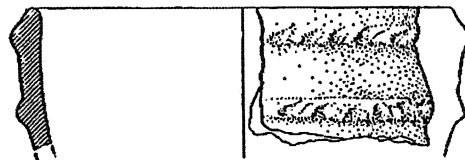

478

Ciste 1.2

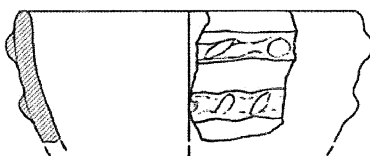

479



480

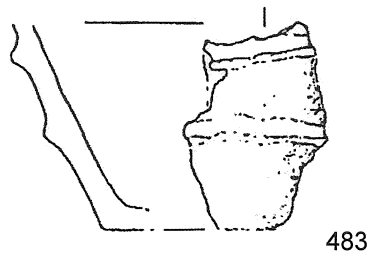
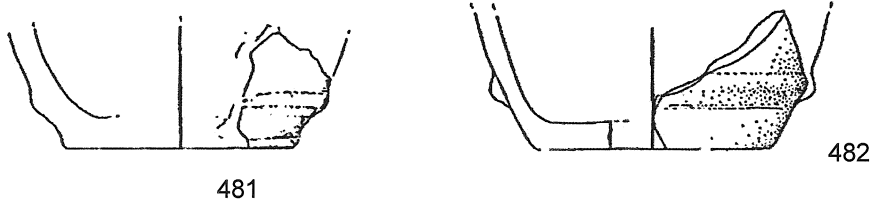

Ciste: fondi attribuibili al tipo 1.2

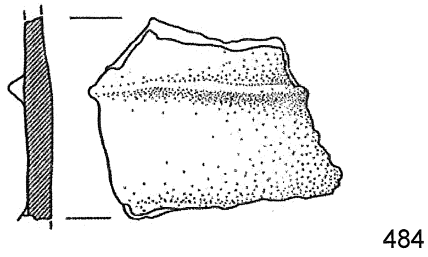

Ciste: frammento di parete

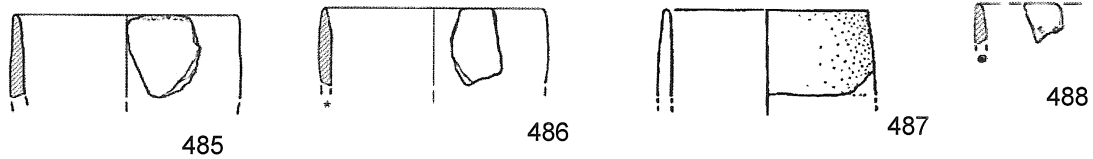

Bicchieri 1.1

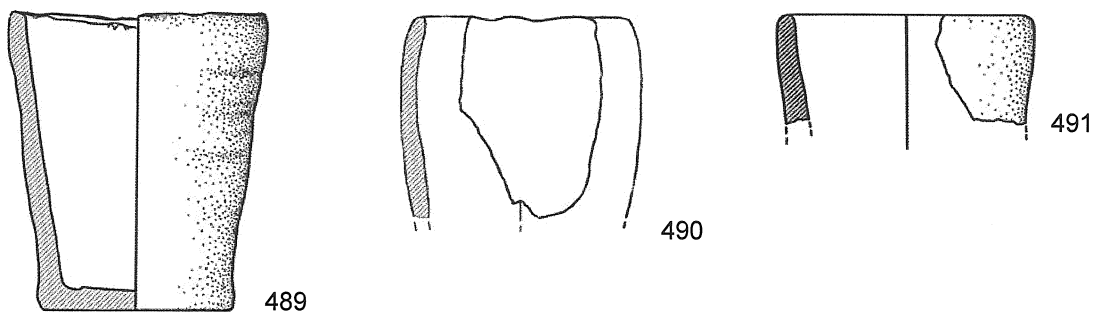

Bicchieri 1.2

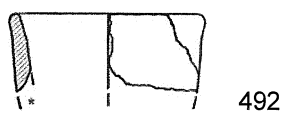

Bicchieri 1.3

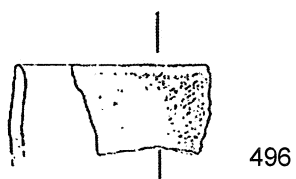
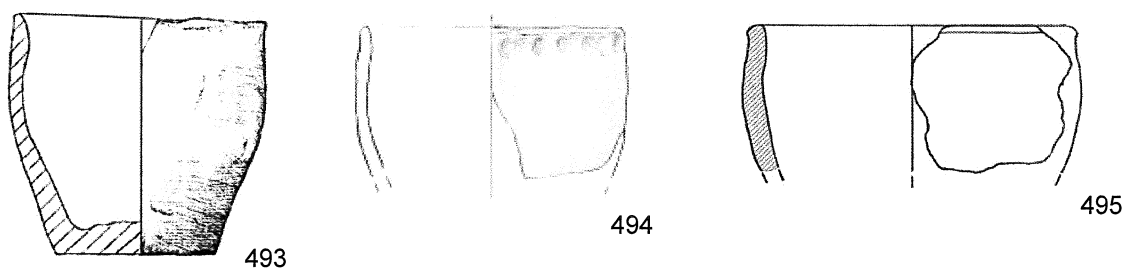

Bicchieri 2.1

TAV. 51

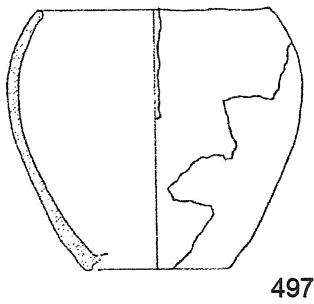

497

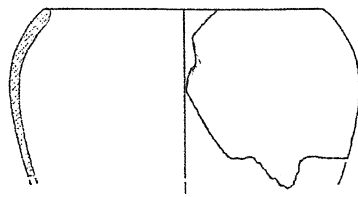

498

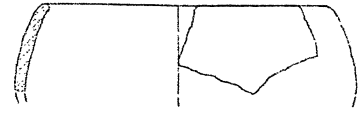

499



500

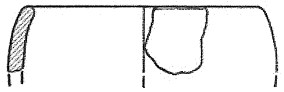

501



502



503

Vasi-bicchieri 1.1.a



504

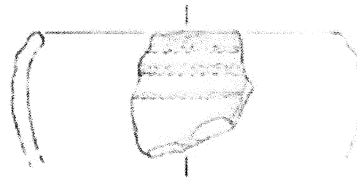

505

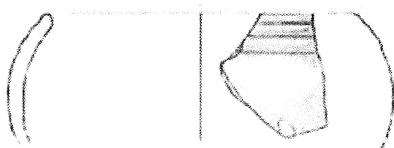

506



507

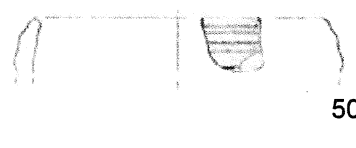

508

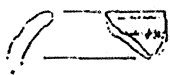

509

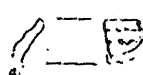

510



511



512

Vasi-bicchieri 1.1.b

TAV. 52

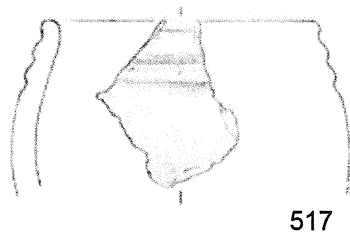
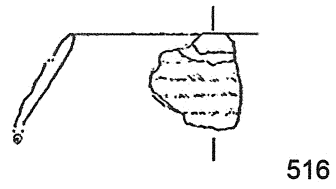
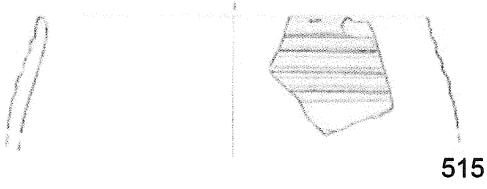
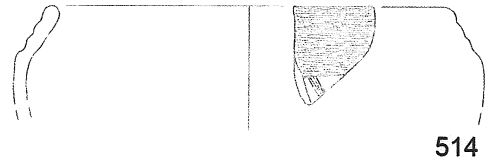
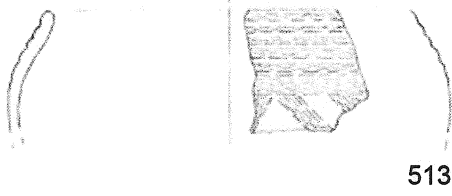

Vasi-bicchiera 1.2

TAV. 53

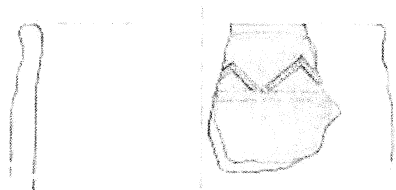

518

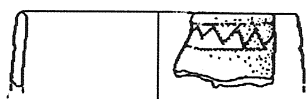

519



520



521

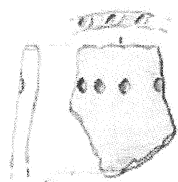

522



523

Vasi-bicchiere 2.1



524

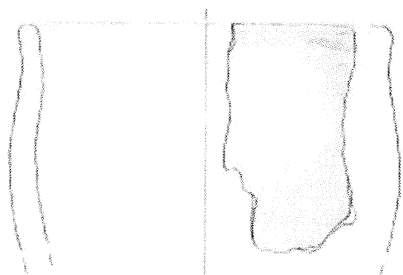

525

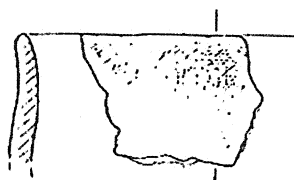

526

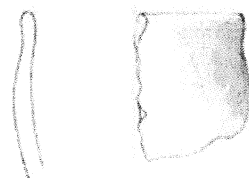

527

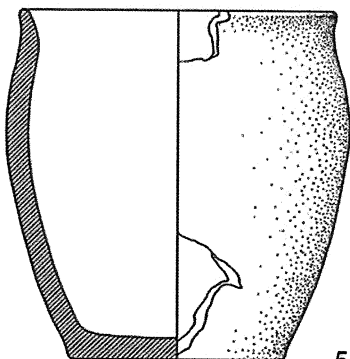

528

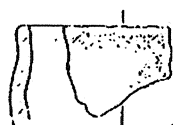

529

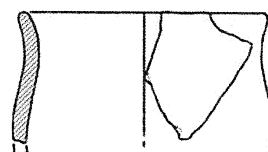

530

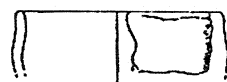

531



532



533

Vasi-bicchiere 2.2.a

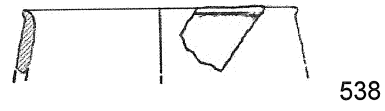
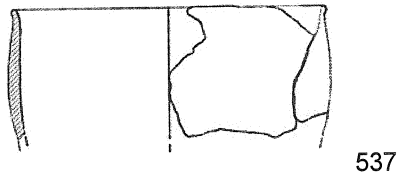
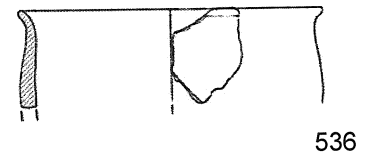
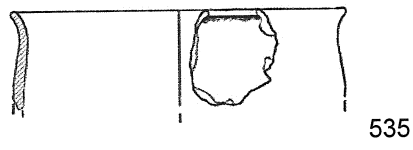
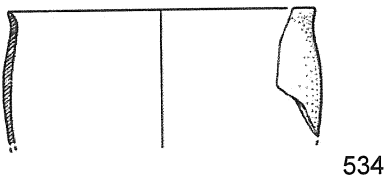

Vasi-bicchieri 2.2.b

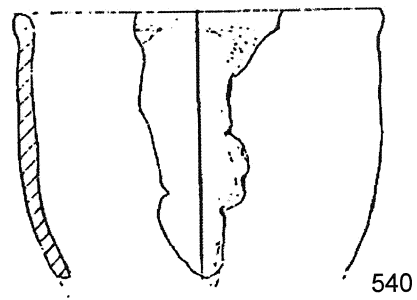
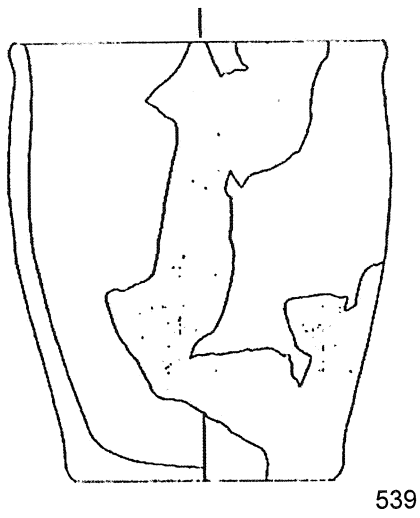

Vasi-bicchieri 2.2.c

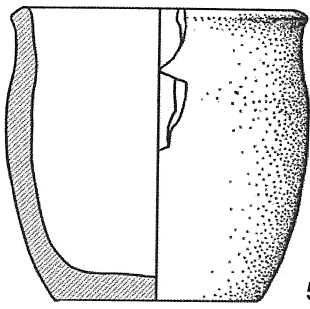

541

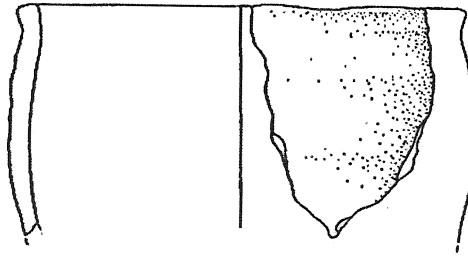

542

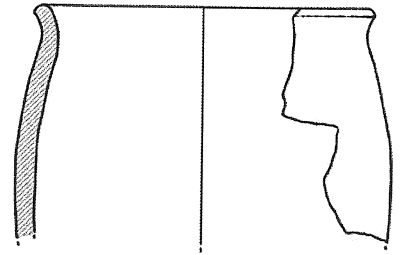

543

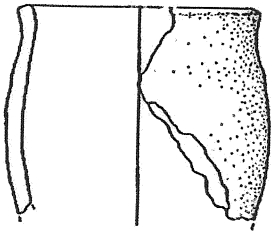

544

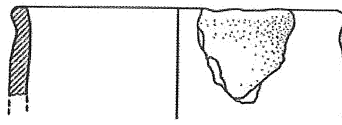

545

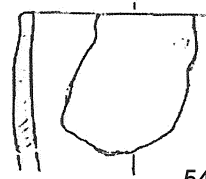

546

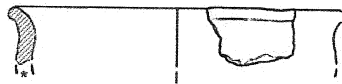

547

Vasi-bicchieri 2.2.d

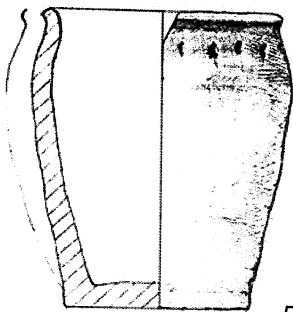

548

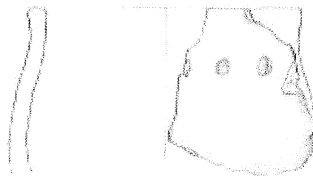

548

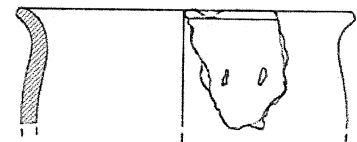

550

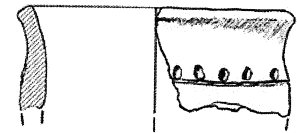

551

Vasi-bicchieri 2.2.e

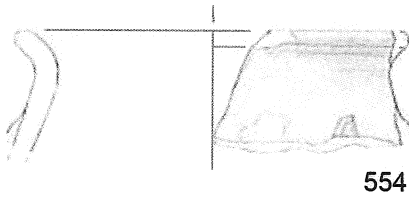
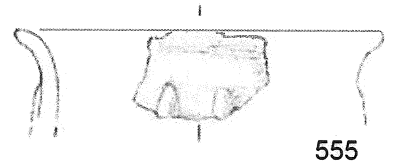
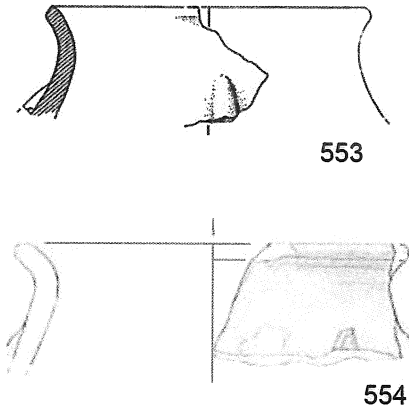
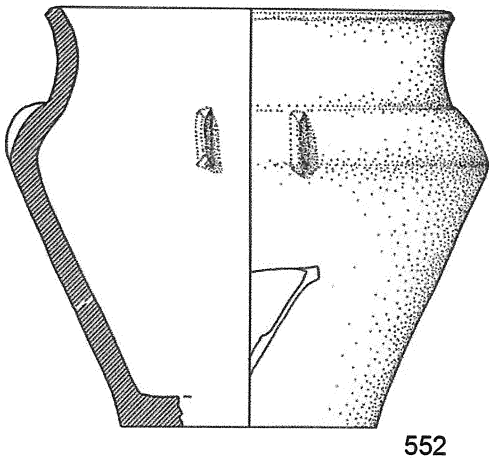

Ollette 1.1

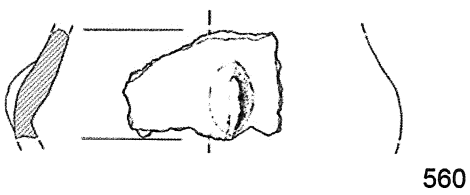
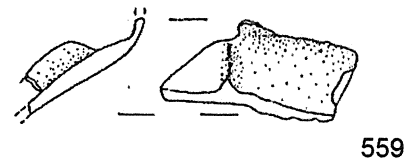
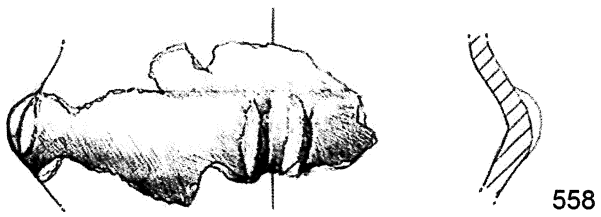
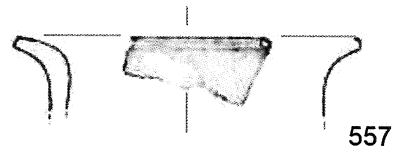
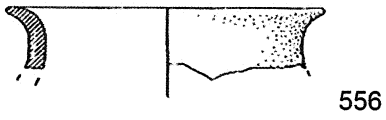

Ollette 1.2

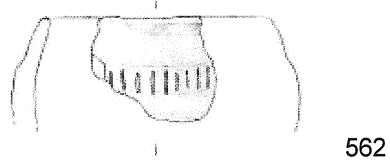
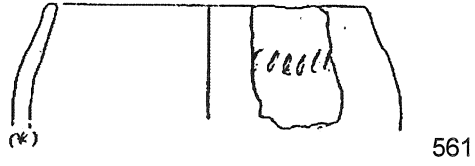

Ollette 2.1

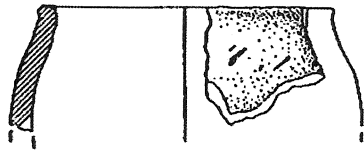

563

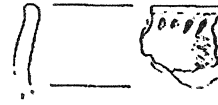

564

Ollette 2.2.a

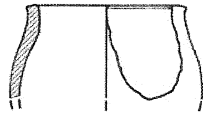

565

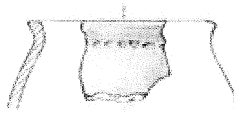

566

Variante del tipo 2.2..a



567

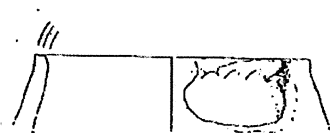

568



569

Ollette 2.2..b

TAV. 59

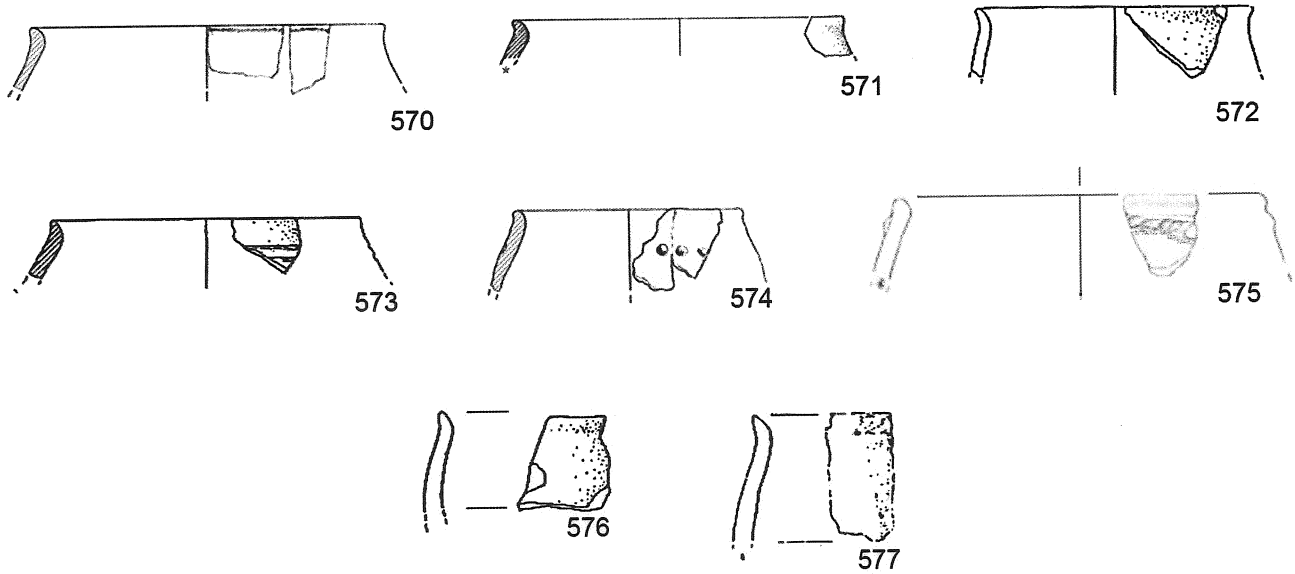

Ollette 2.3

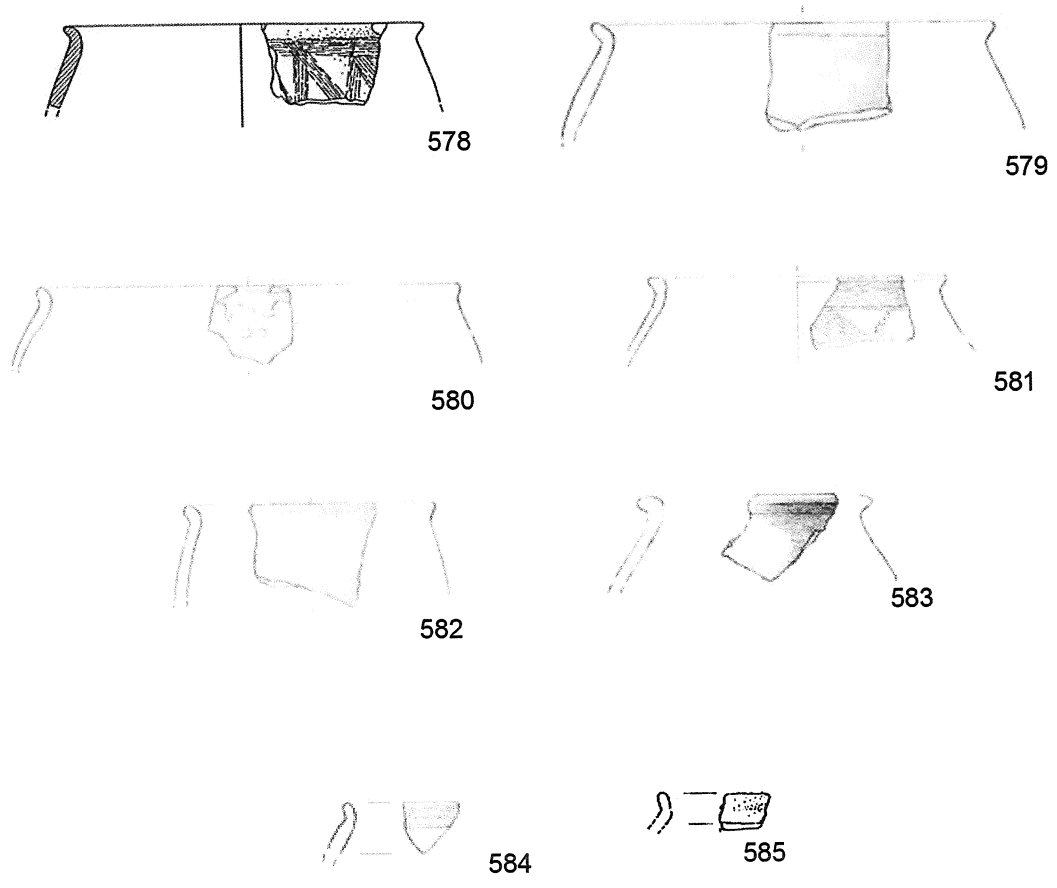

Ollette 2.4

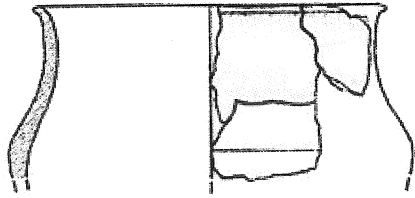

586

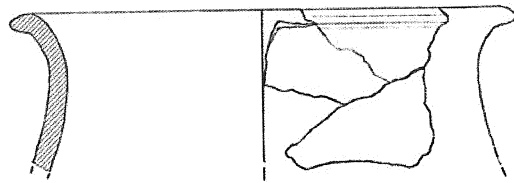

587



588

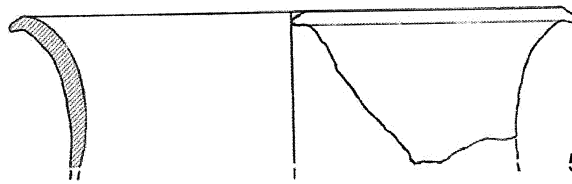

589

TAV. 61

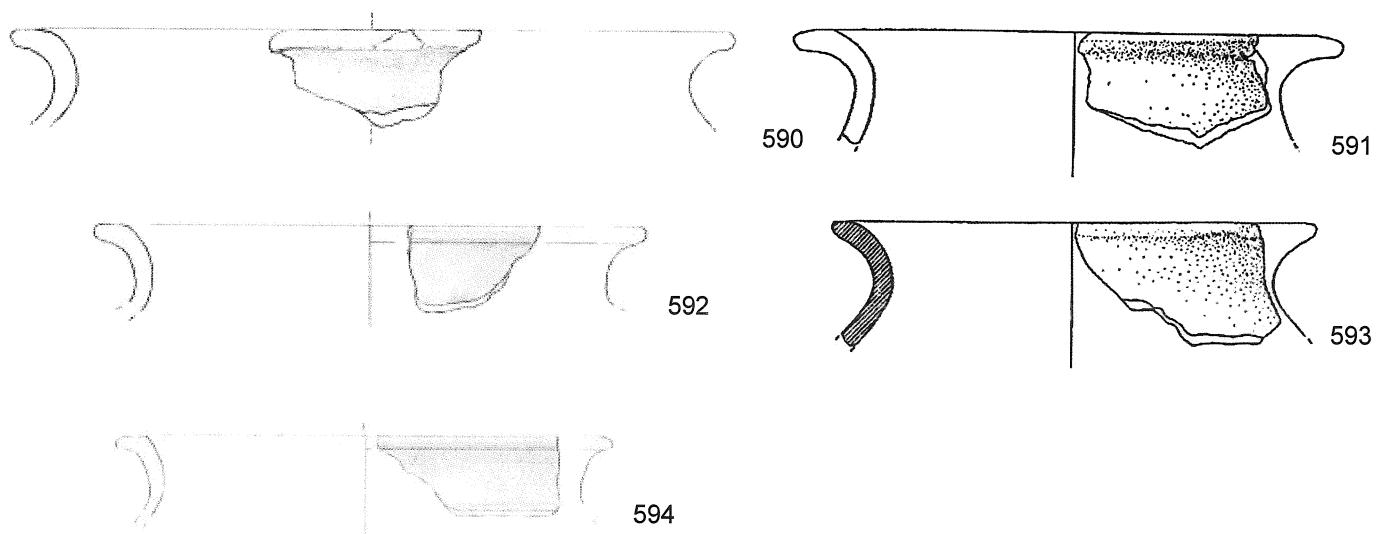

Olle 1.2

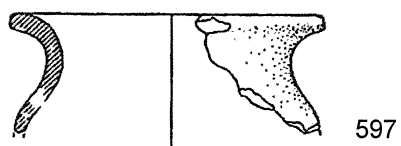
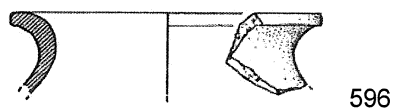
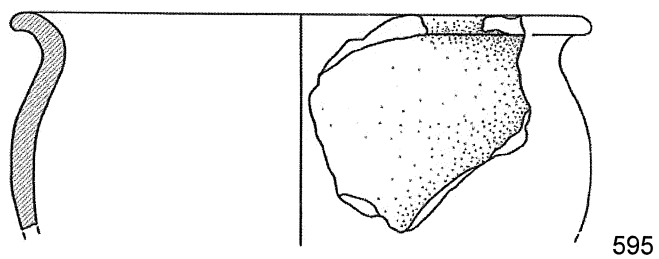

Olle 1.3

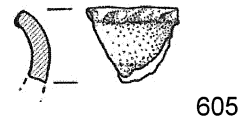
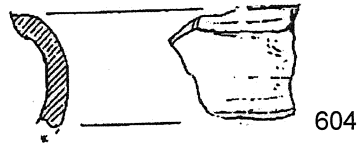
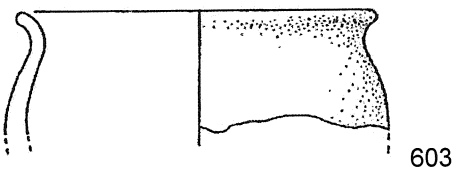
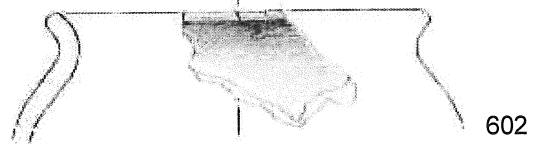
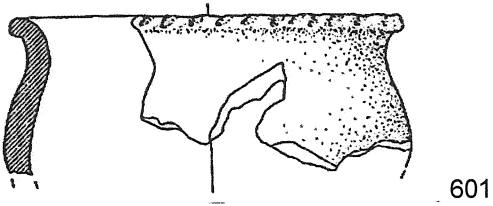
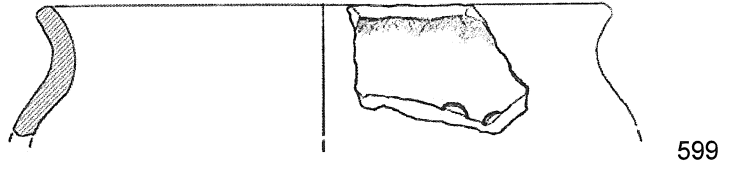
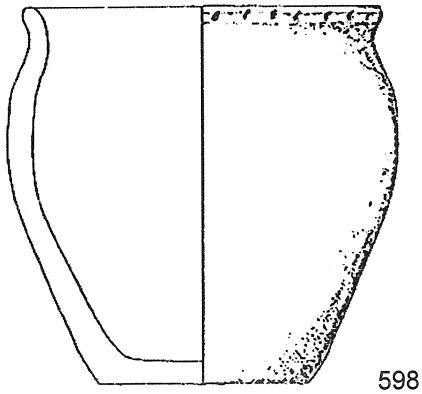

Olle 1.4.a

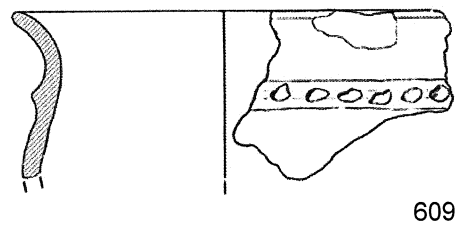
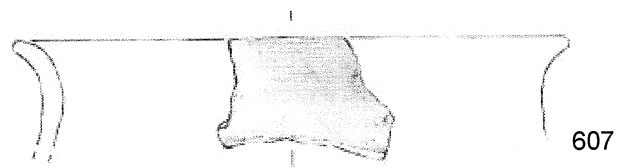
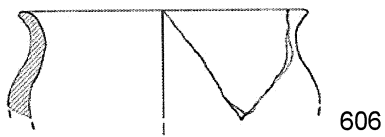

Olle 1.4.b

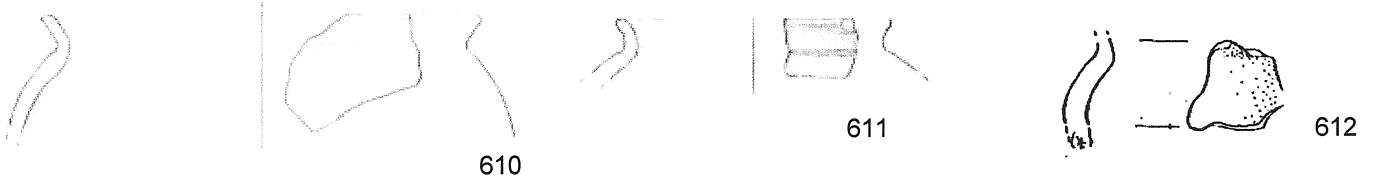

Olle 1.4.c

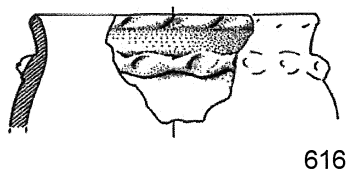
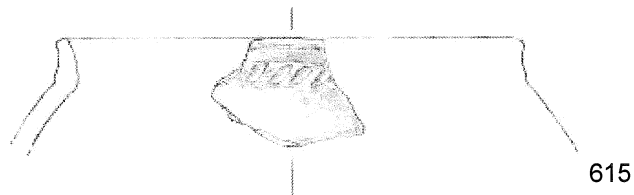
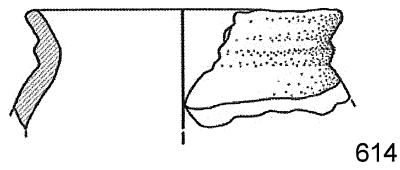
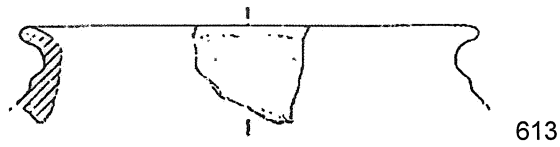

Olle 1.4.d

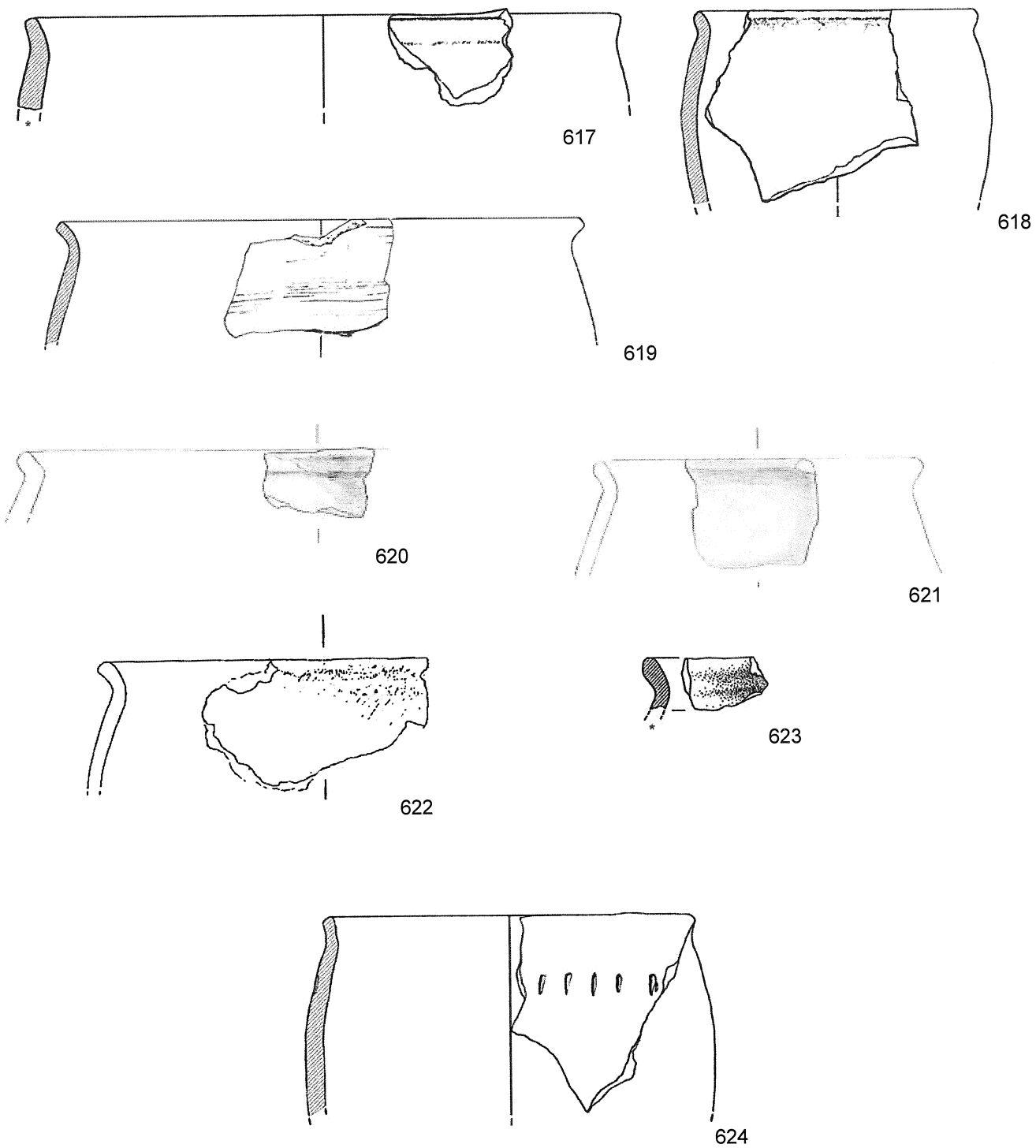

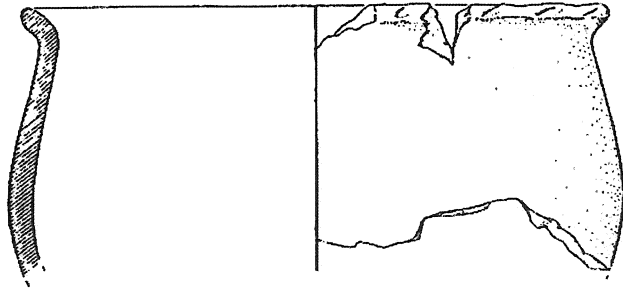

625

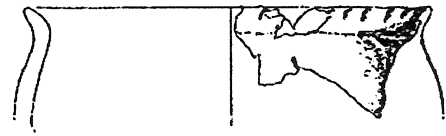

626

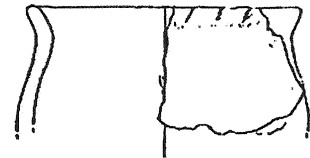

627

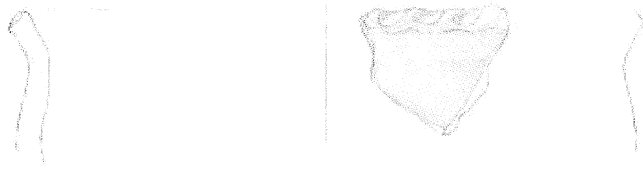

628



629

Olle 1.5.b

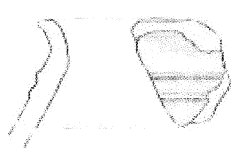

630



631

Olle 1.6



632

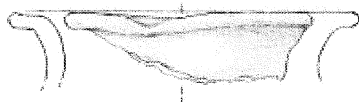

633

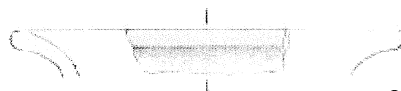

634

Frammenti di olla genericamente attribuibili alla famiglia 1

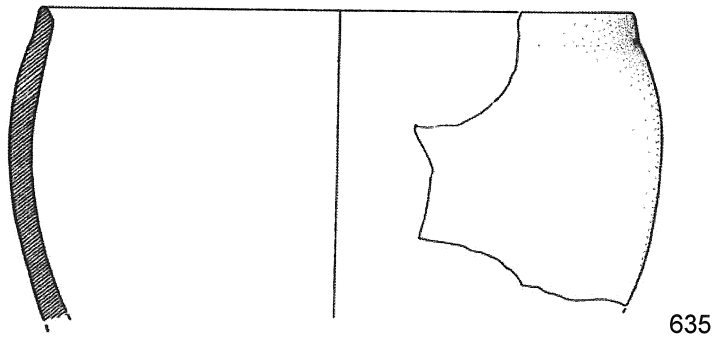

635

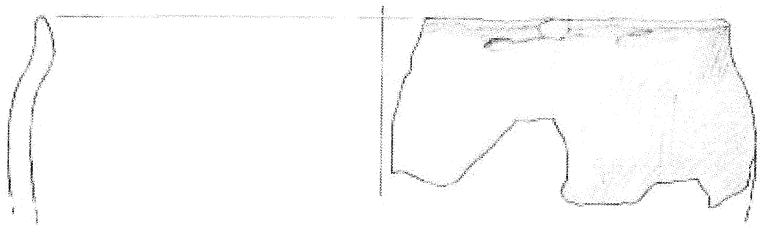

636

Olle 2.1.a



637

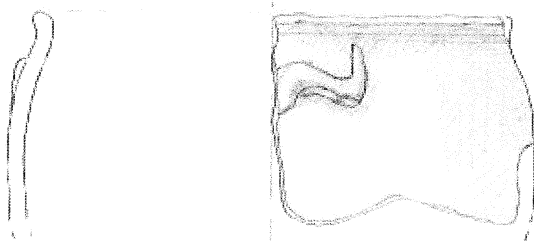

638

Olle 2.1.b

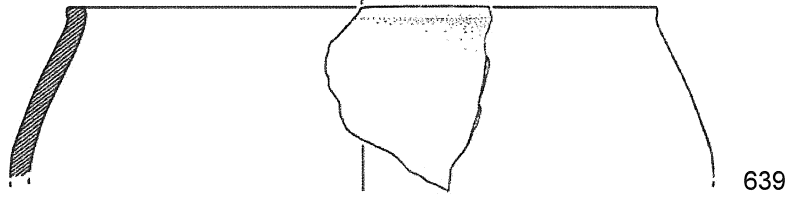

Olle 2.1.c

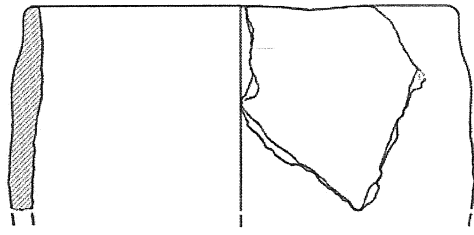

641

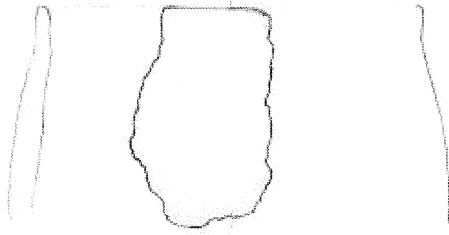

642

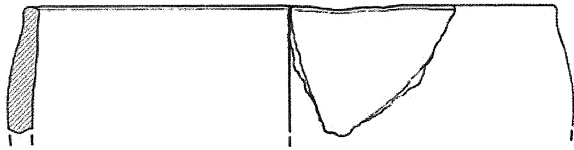

643

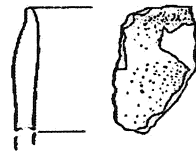

644

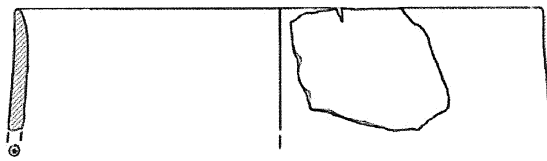

645

Olle 3.1.a

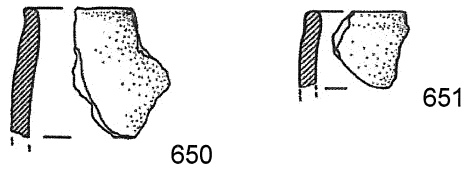
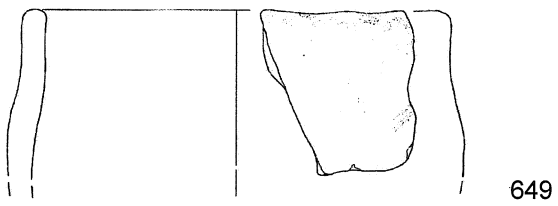
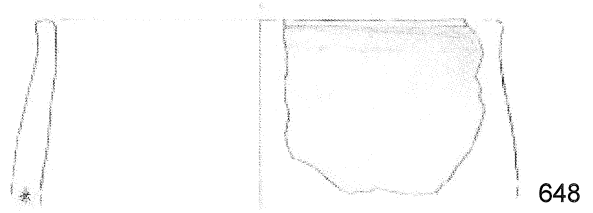
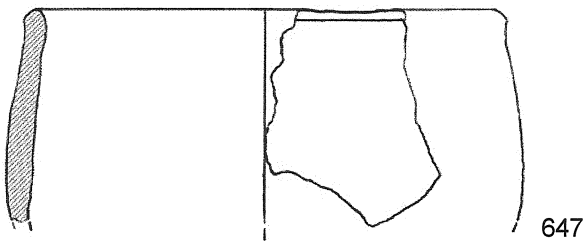
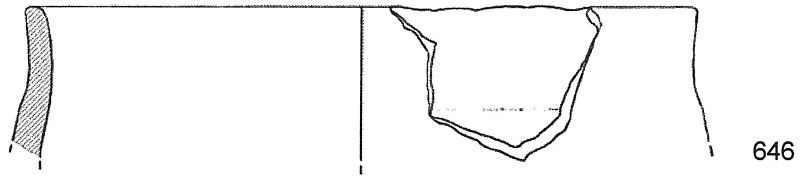

Olle 3.1.b

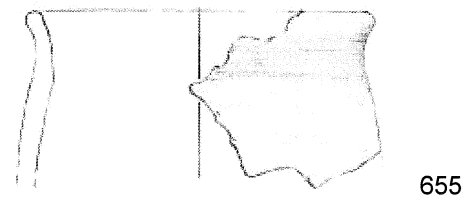
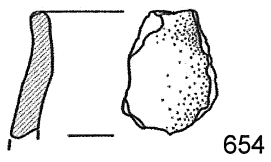
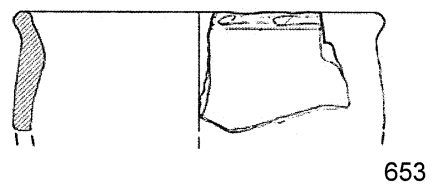
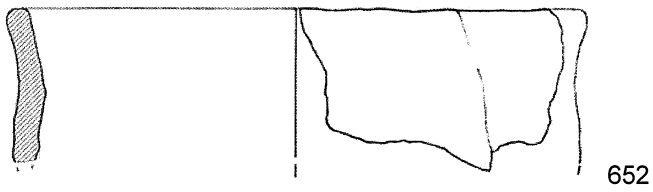

Olle 3.2

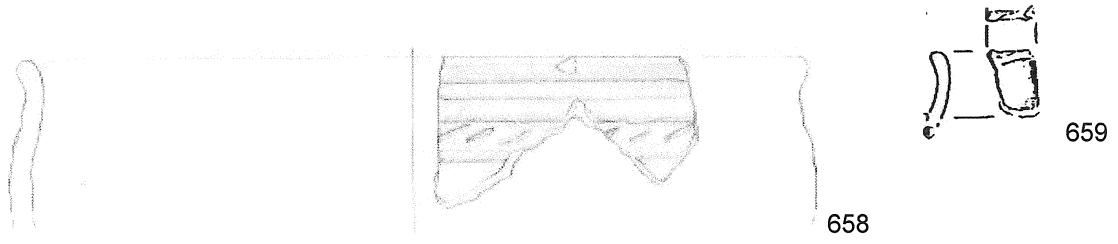
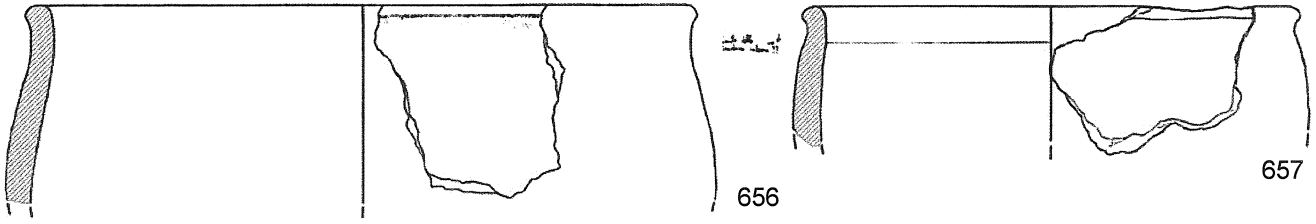

Olle 3.3

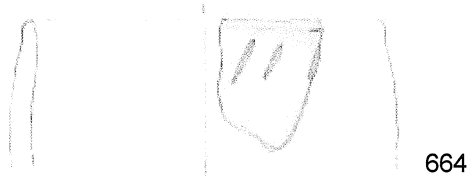
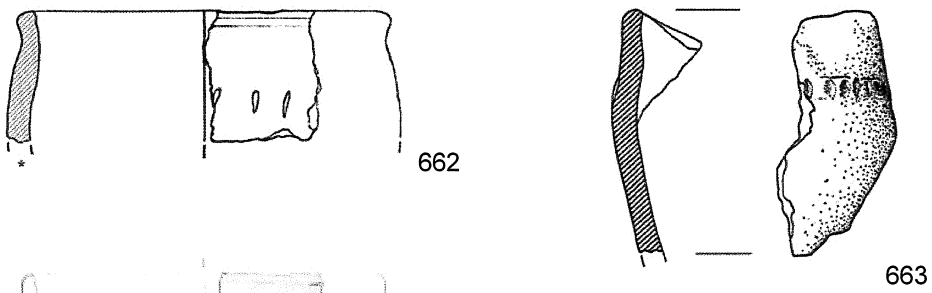
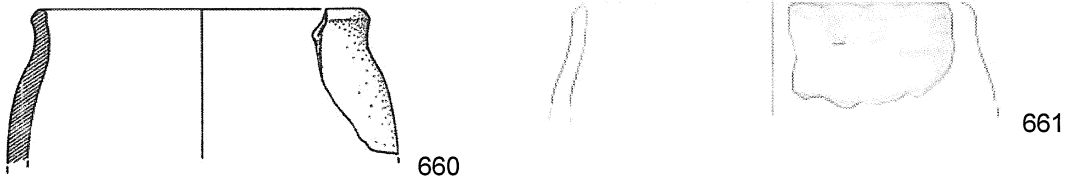

Olle 3.4

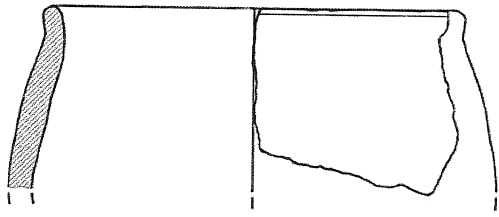

665

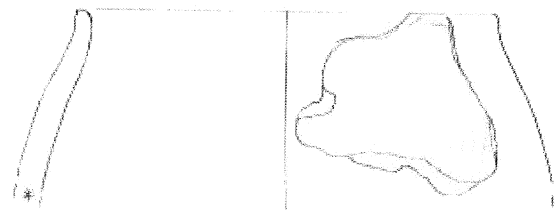

666

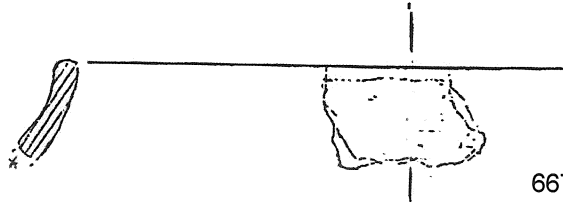

667

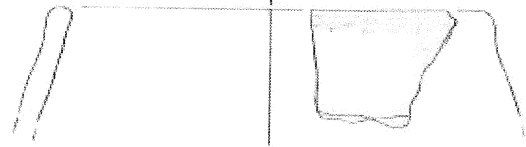

668

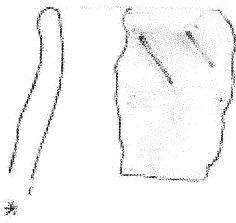

669

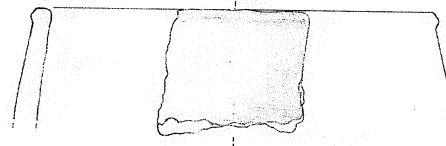

670

Olle 3.5.a

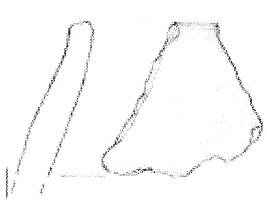

671

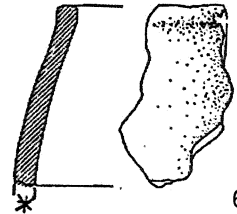

672

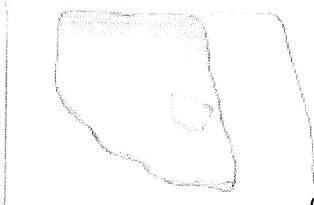

673

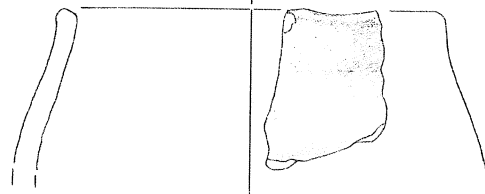

674

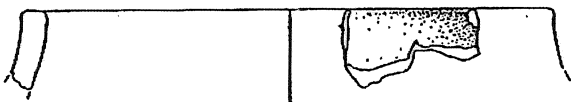

675

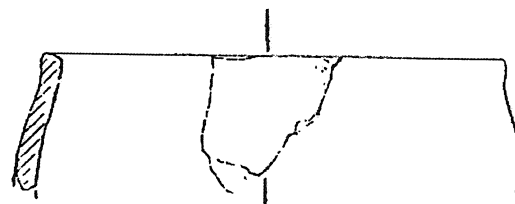

676

Olle 3.5.b

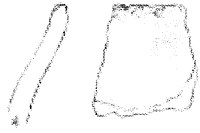

677



678

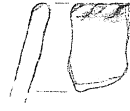

679



680

Olle 3.5.c



681



682

Olle 3.5.d

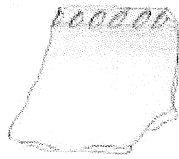

683



684



685



686

Olle 3.5.e



687



688

Olle 3.5.f

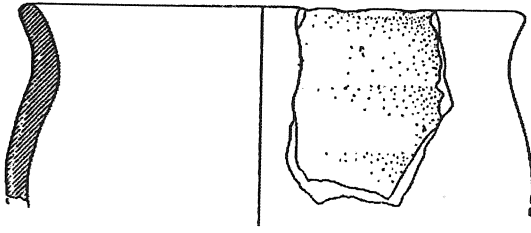

689

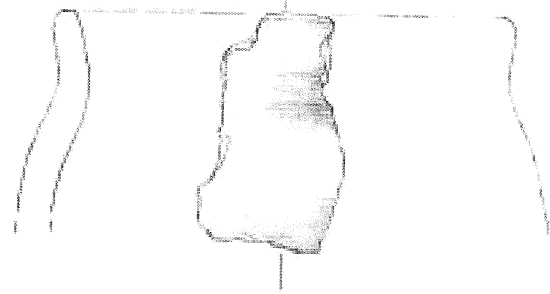

690

Olle 4.1

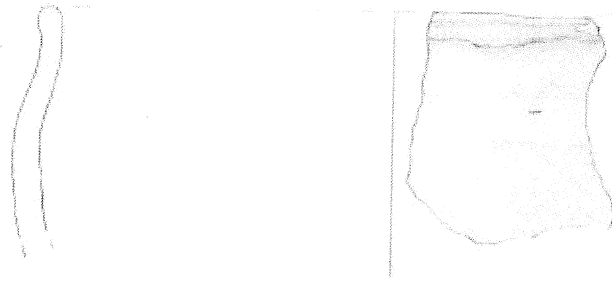

691

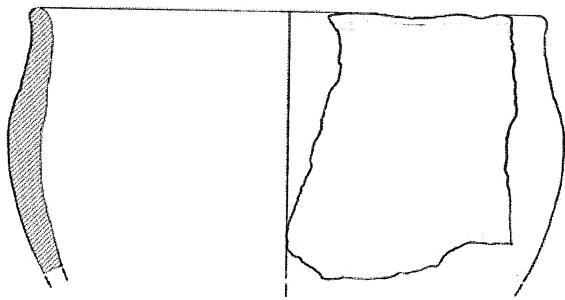

692

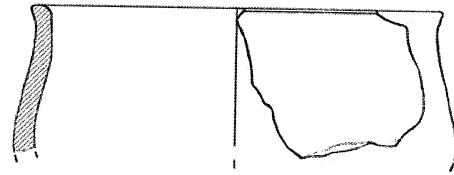

693

Olle 4.2.a

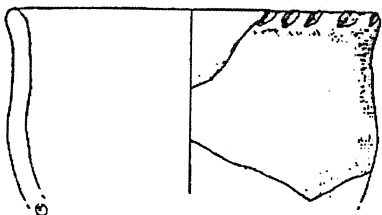

694

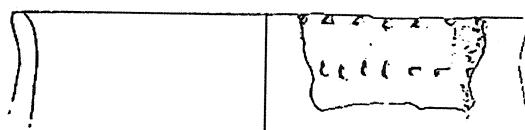

695

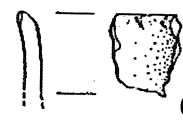

696

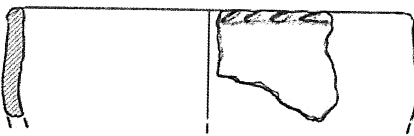

697

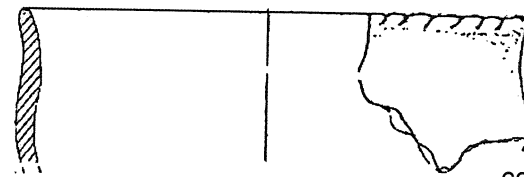

698

Olle 4.2.b

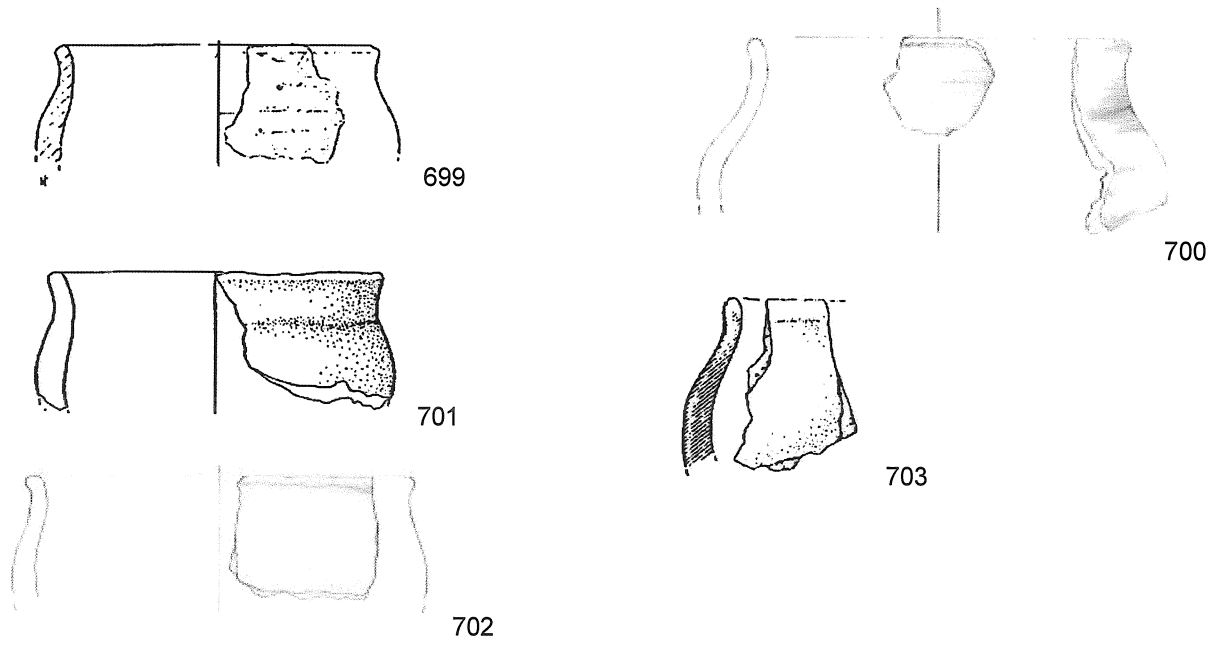

Olle 4.3.a

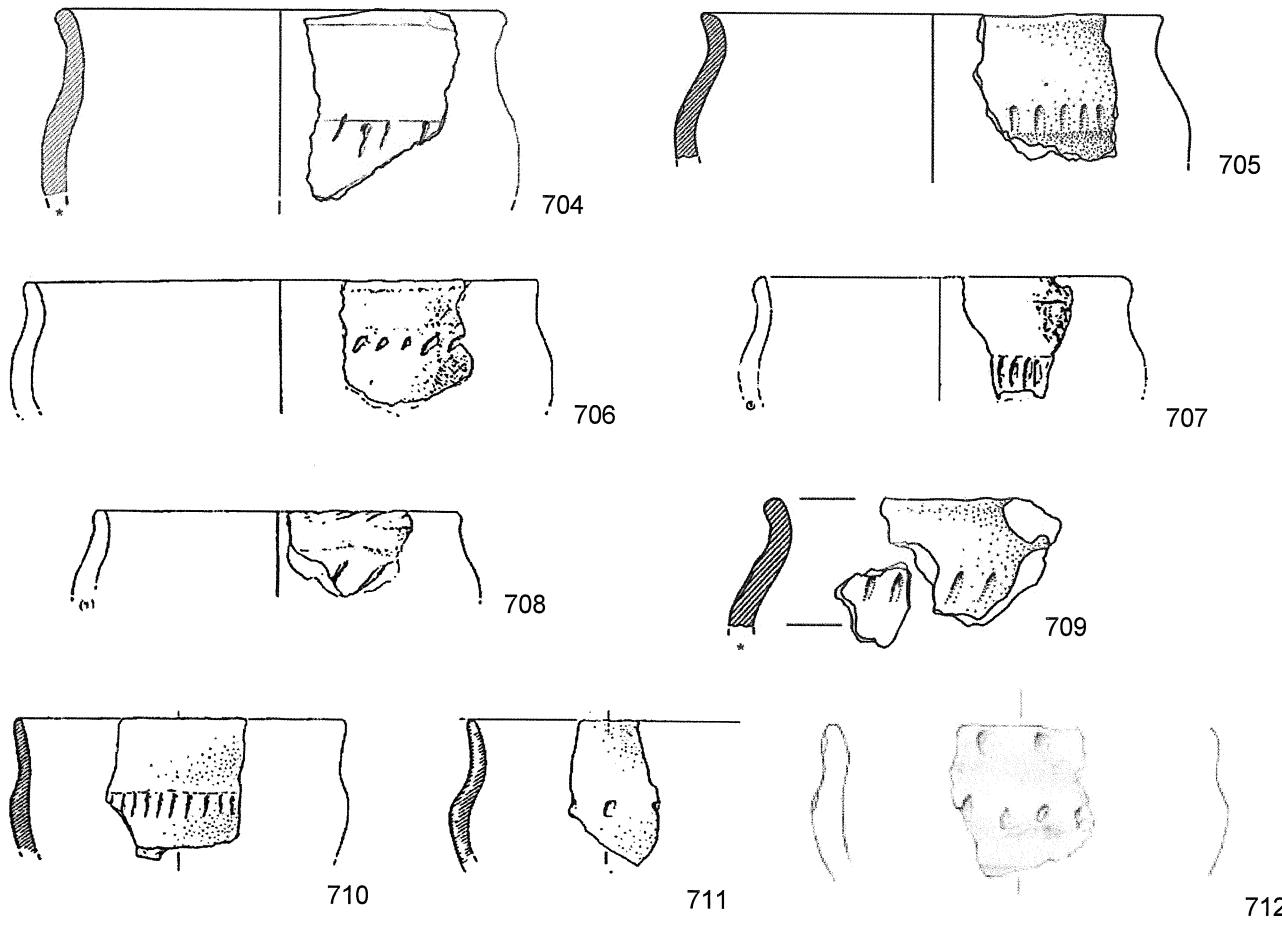

Olle 4.3.b

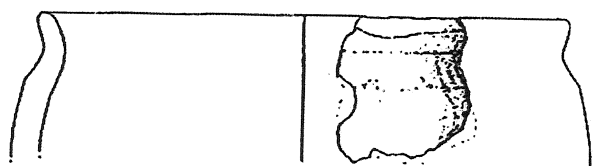

713

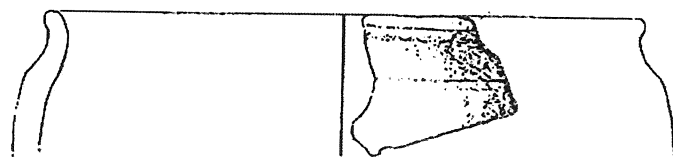

714

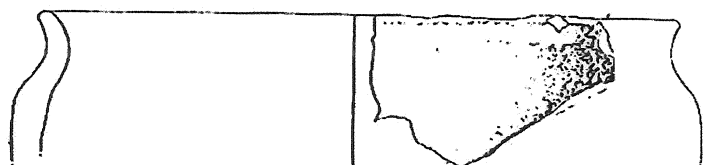

715

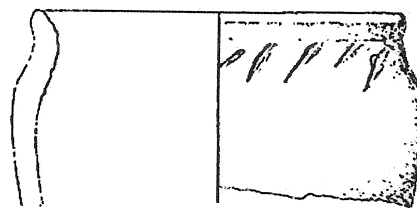

716

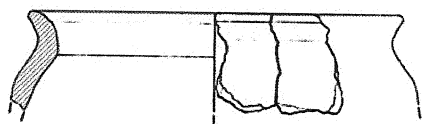

717

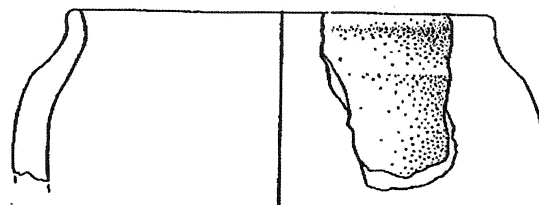

718

Olle 5.1

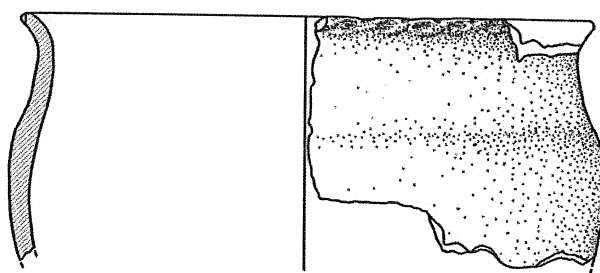

719

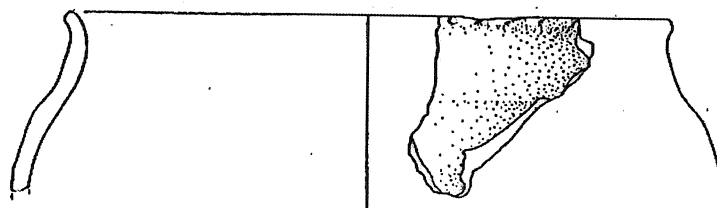

720

Olle 5.2

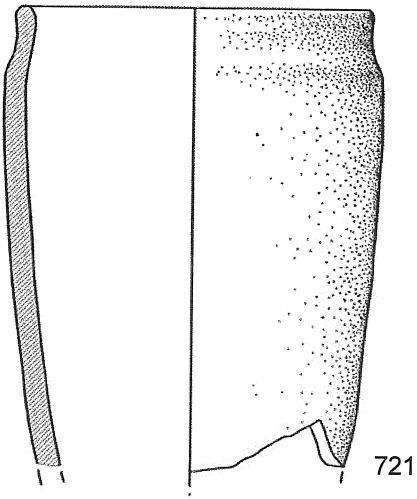

721

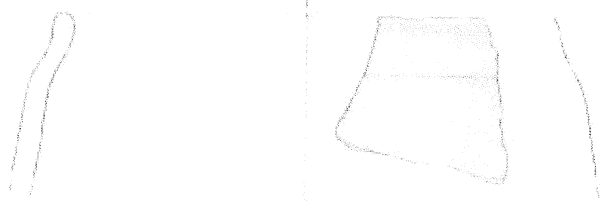

722

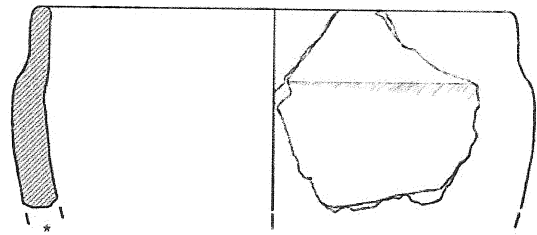

723

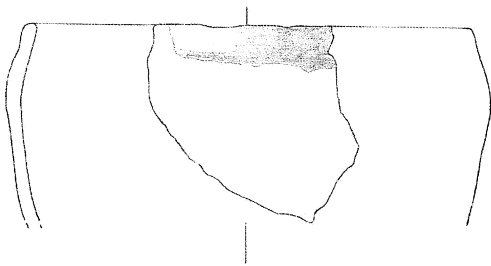

724

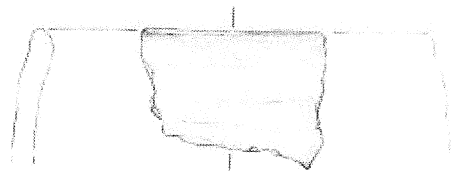

725



726

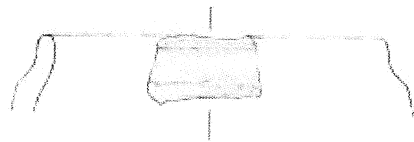

727



728

Olle 5.3.a

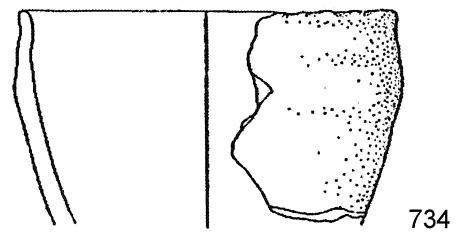
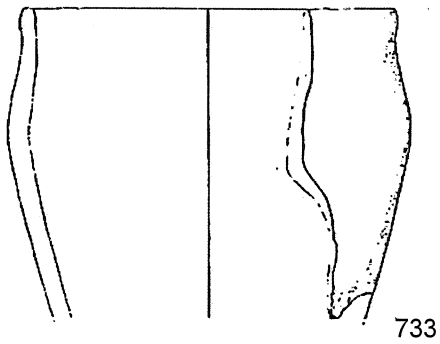
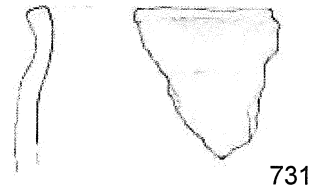
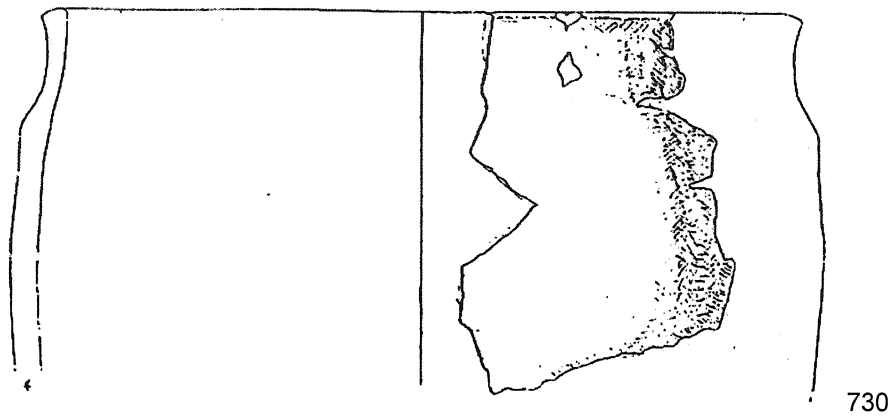
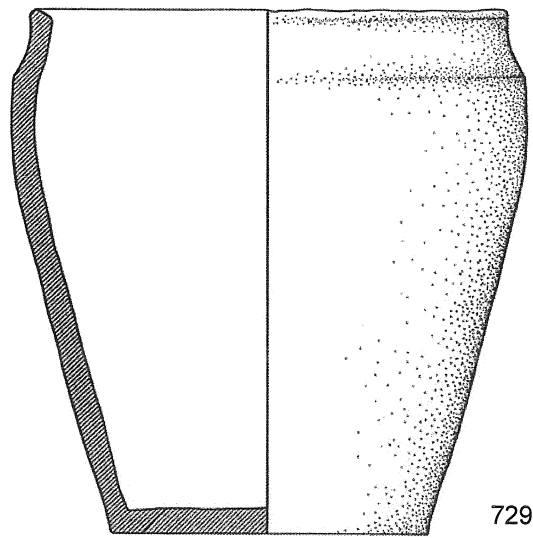

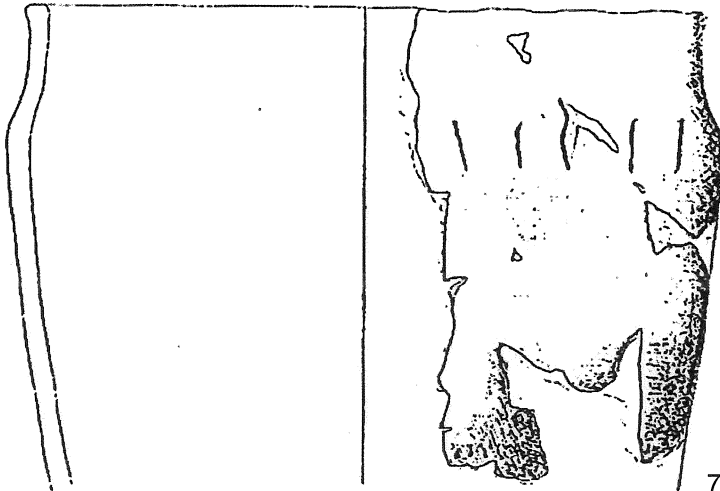

735

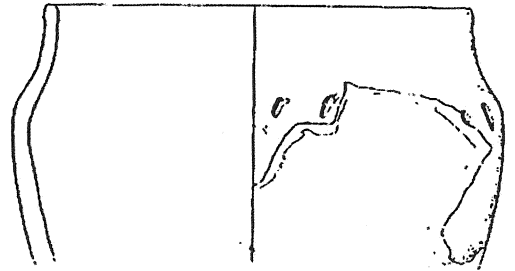

736

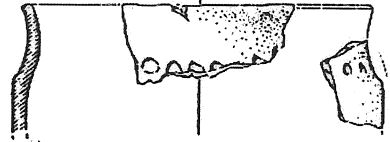

737

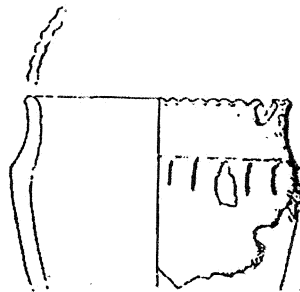

738

Olle 5.3.c

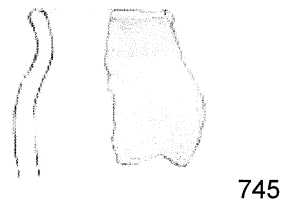
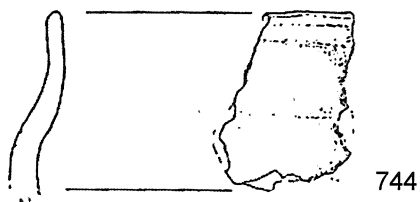
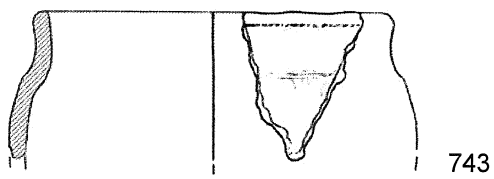
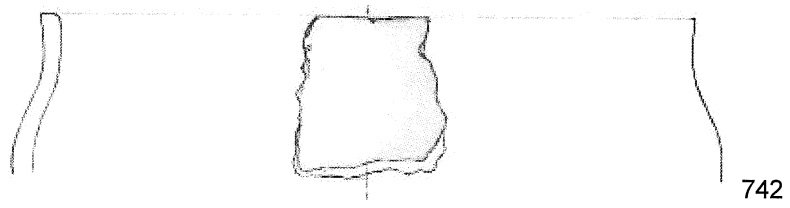
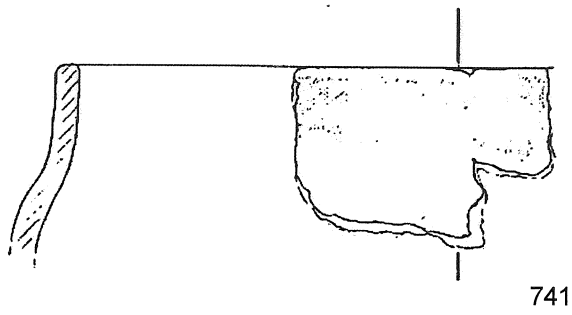
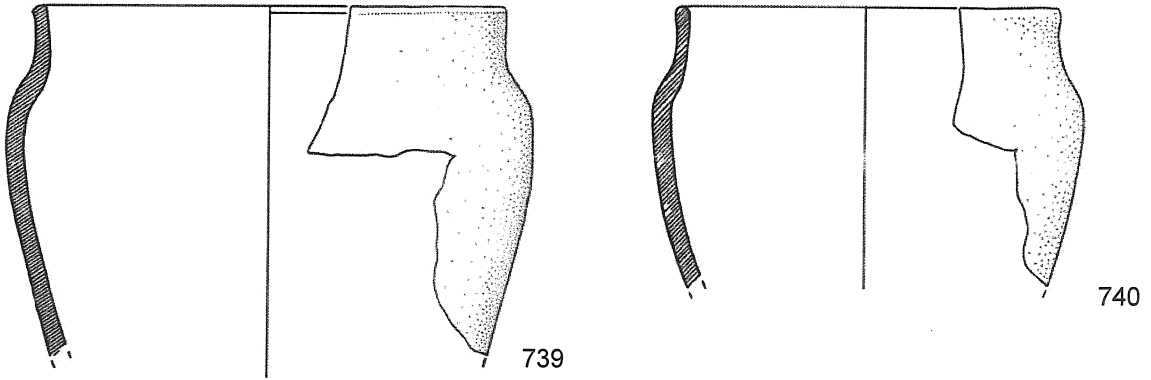

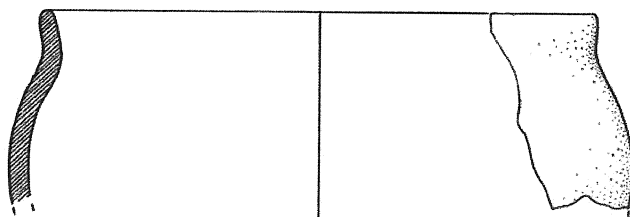

746

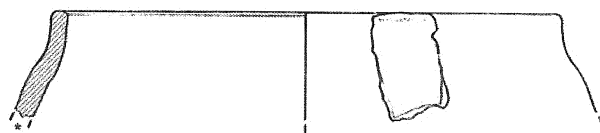

747

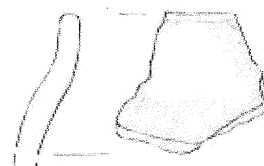

748



749



750

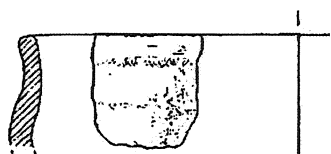

751

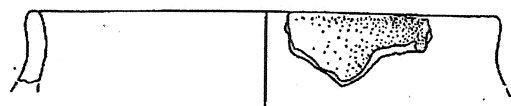

752



753



754

Olle 5.3.d

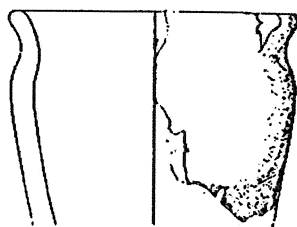

755

Variante di 5.3.d

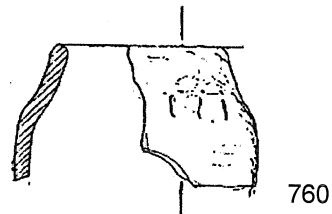
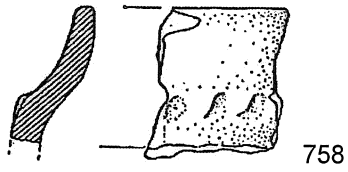
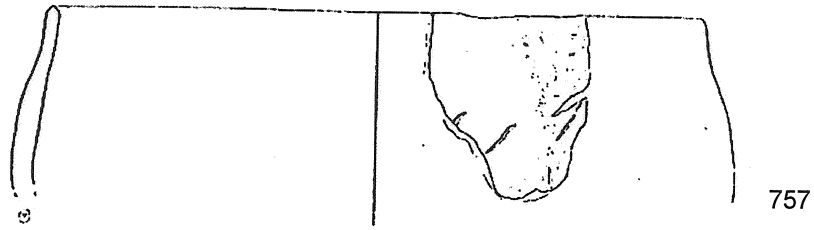
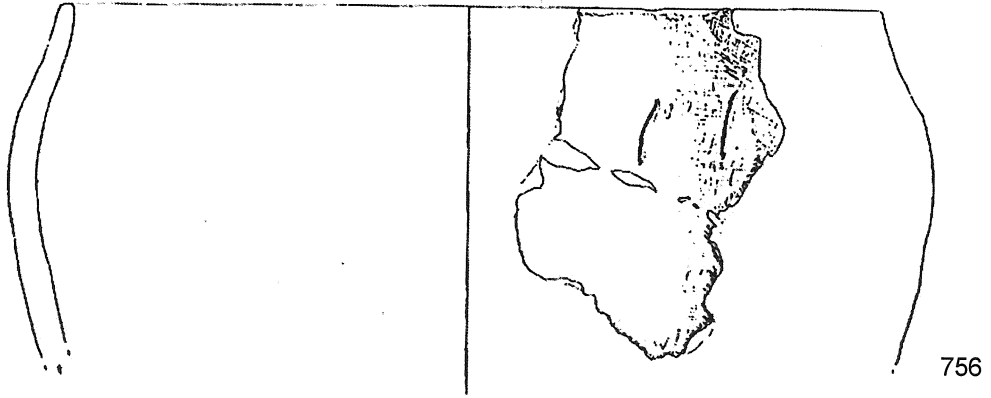

Olle 5.3.e

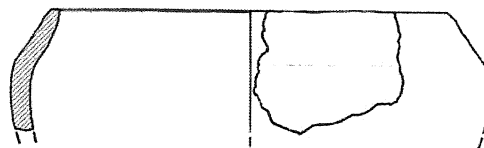

Variante di 5.3.e

761

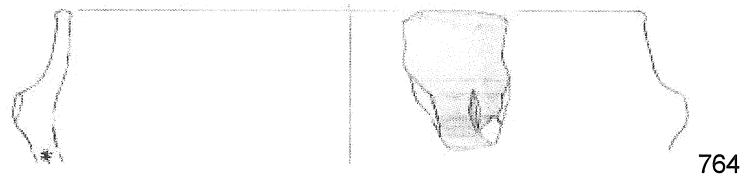
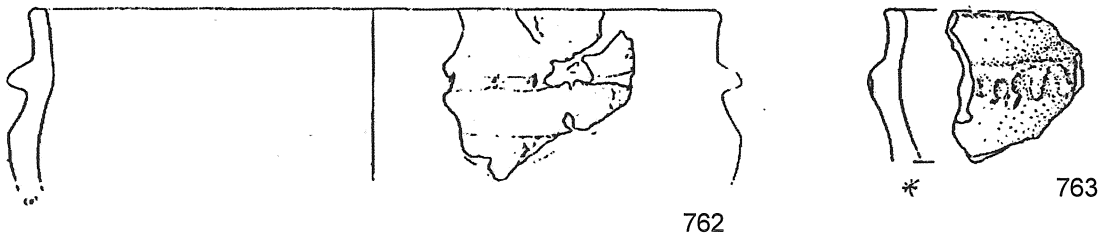

Olle 5.4

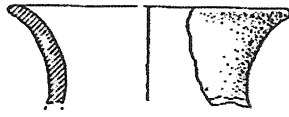

765

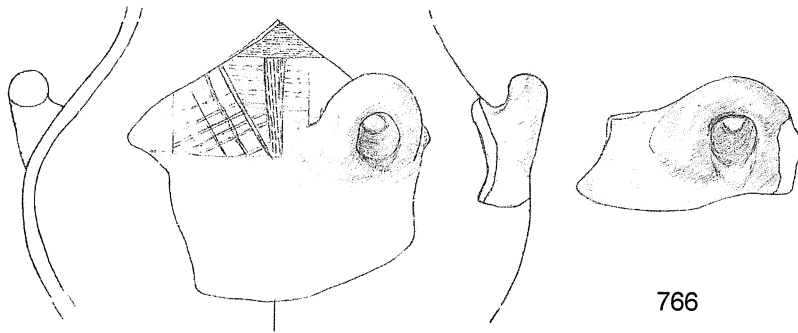

766

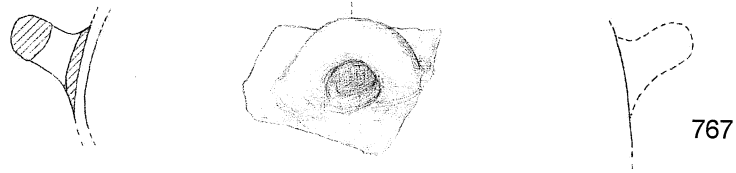

767

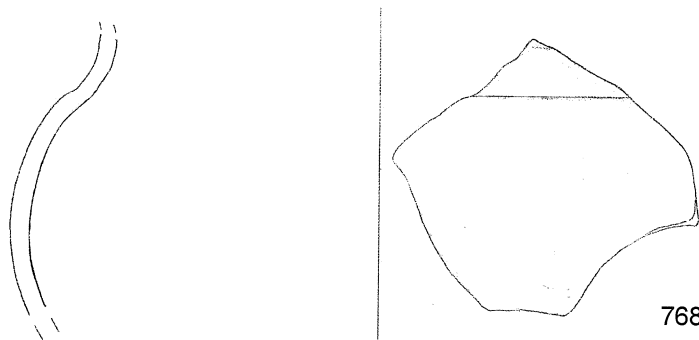

768

Frammenti genericamente attribuibili a olle

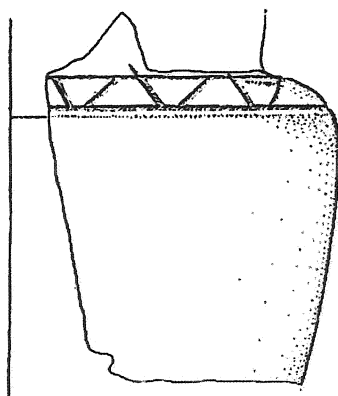
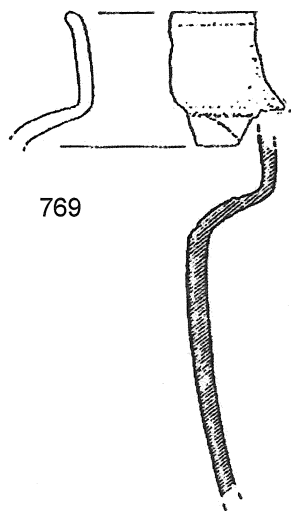

Vasi situliformi 1.1.a

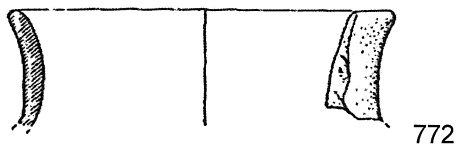
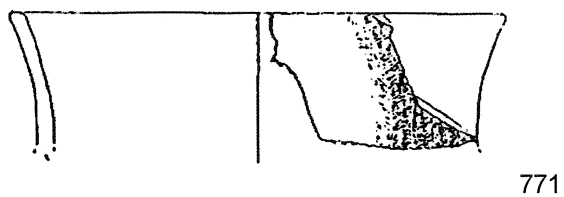

Vasi situliformi 1.1.b

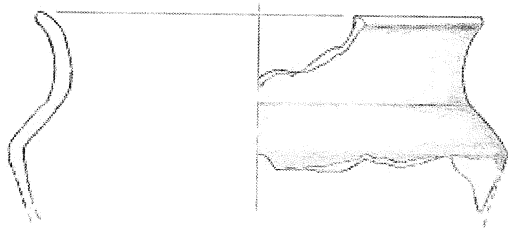

773

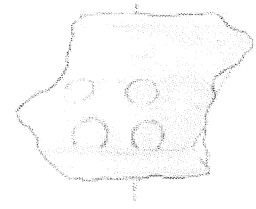

774

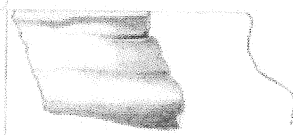

775

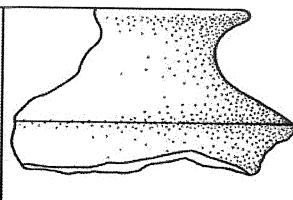
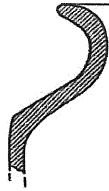

776



777



778

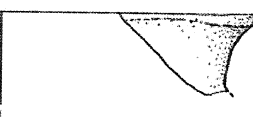

779

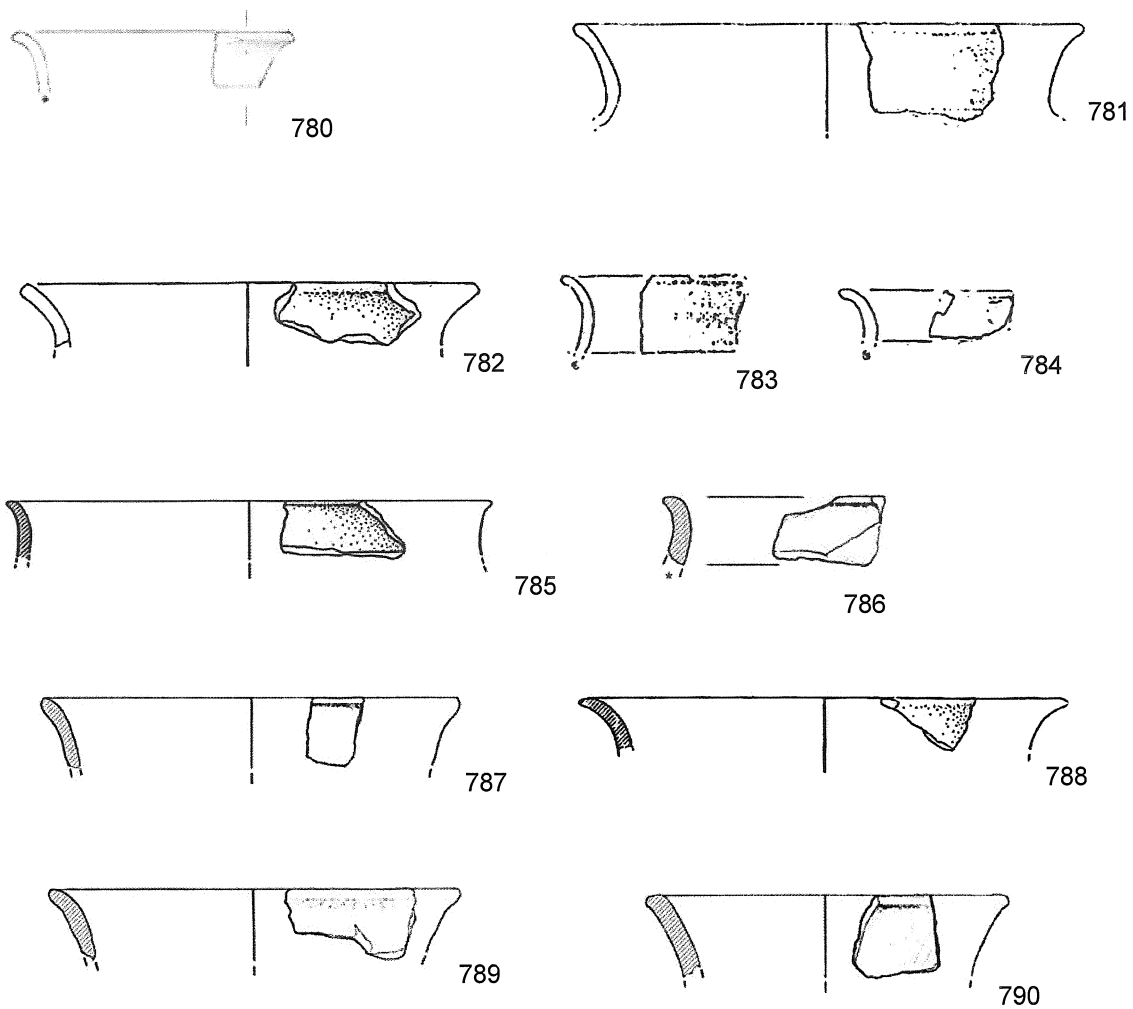

Vasi situliformi 1.2

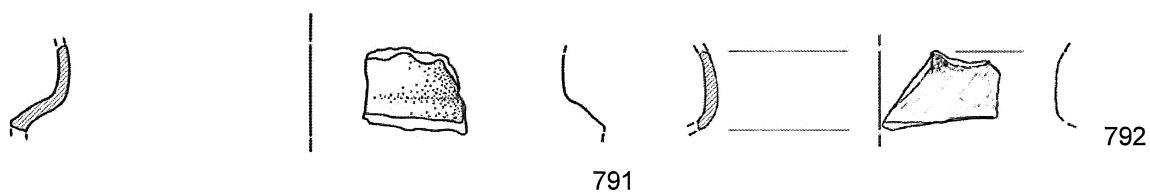

Frammenti di vaso situliforme attribuibili al tipo 1.2

TAV. 87

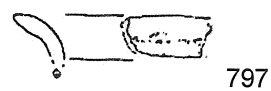
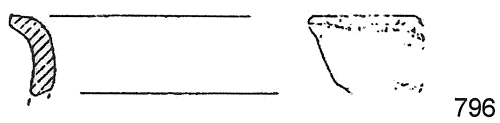
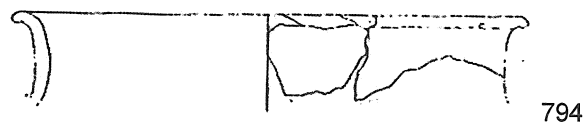
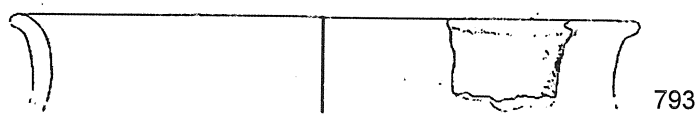

Vasi situliformi 2.1

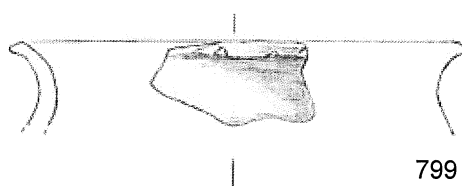
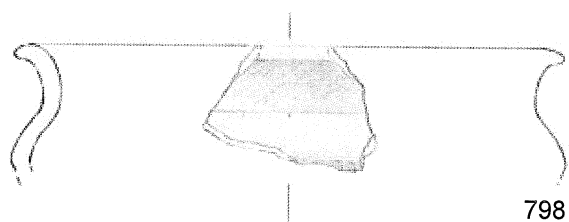

Vasi situliformi 2.2



801

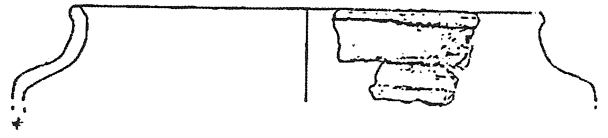

802

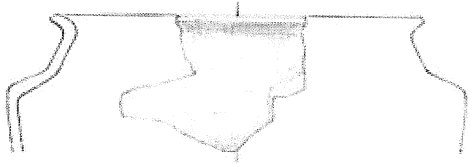

803

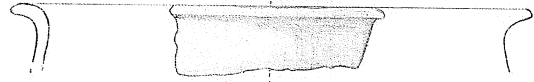

804



805



806

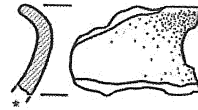

807

Vasi situliformi 2.3.a

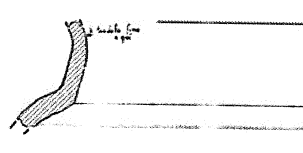

808



809



810



811



812

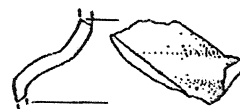

813

Frammenti di vaso situliforme attribuibili al tipo 2.3.a

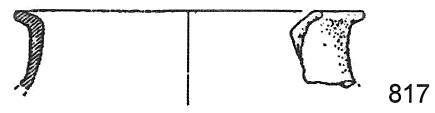
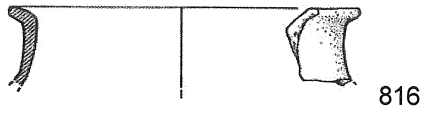

Vasi situliformi 2.3.b

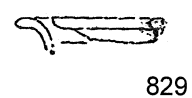
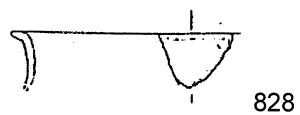
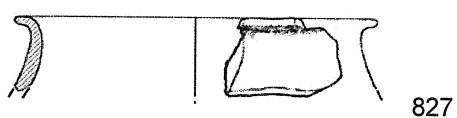
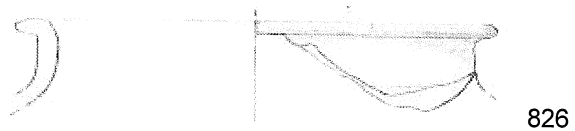
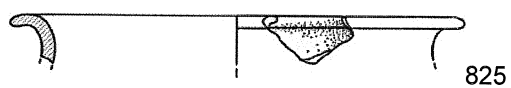
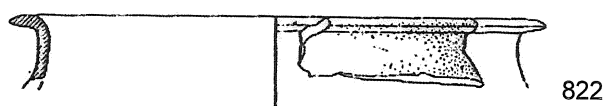
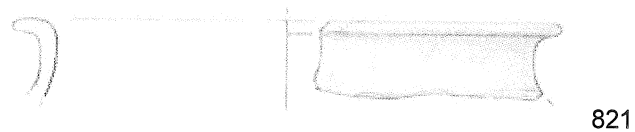
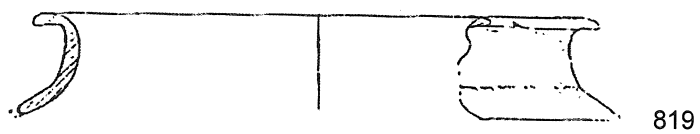

Vasi situliformi 2.3.c



Frammenti di vaso situliforme attribuibili al tipo 2.3.c

TAV. 91

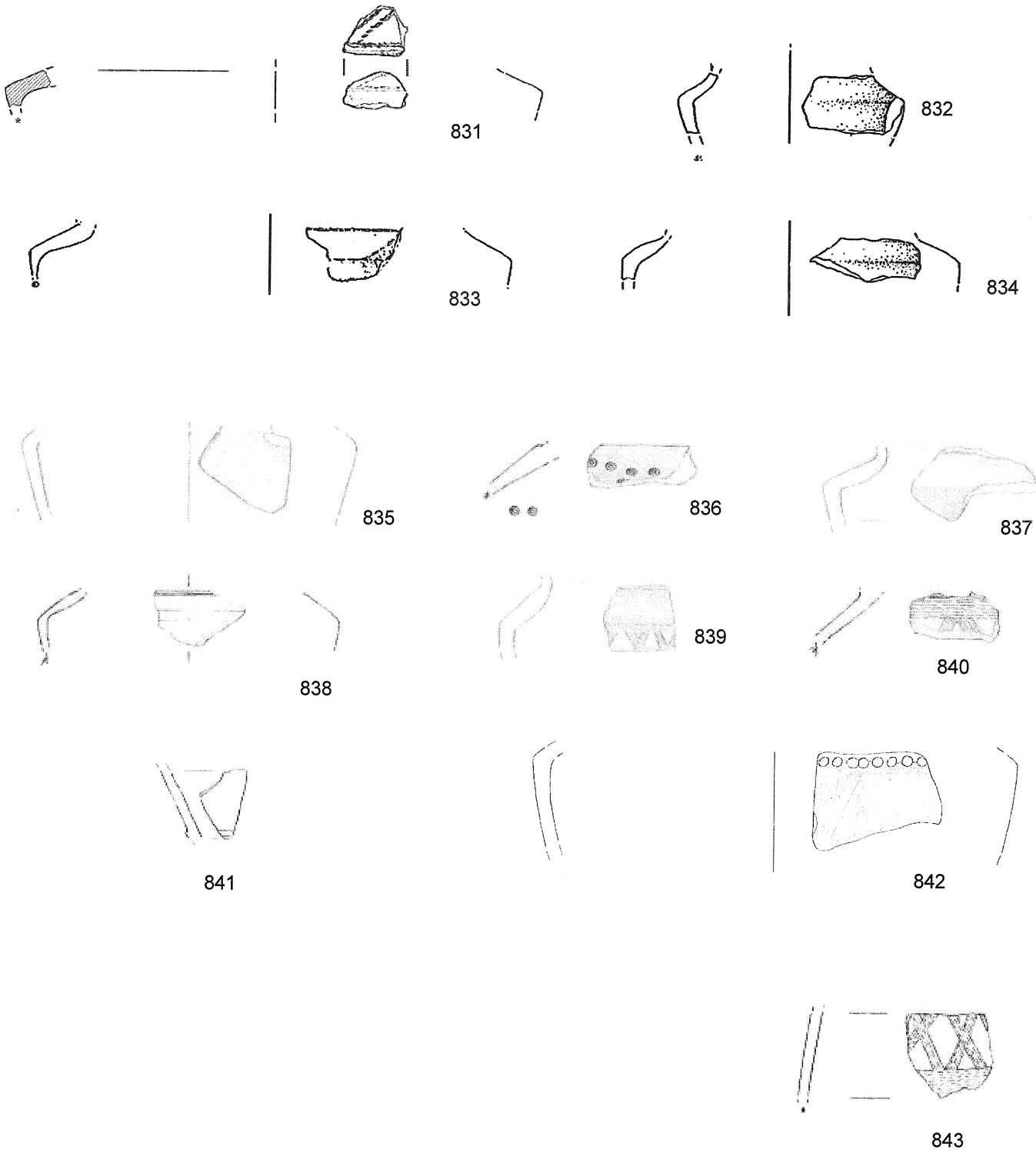

Frammenti di vaso situliforme non
attribuibili con sicurezza ad alcun tipo.

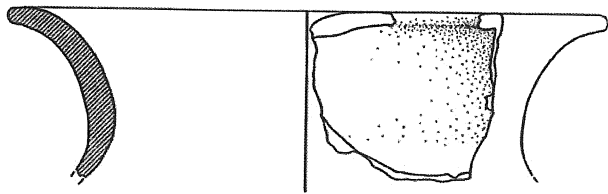

844

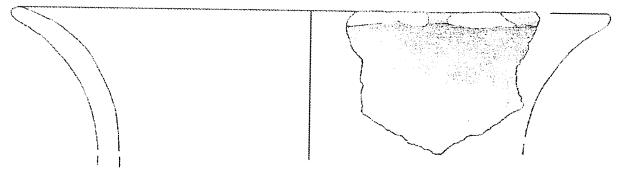

845

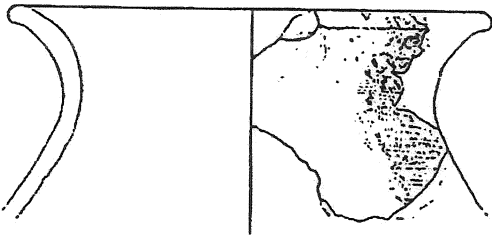

846



847

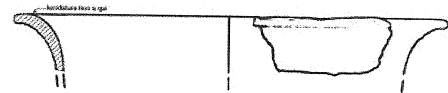

848

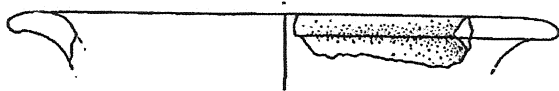

849

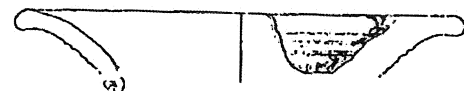

850

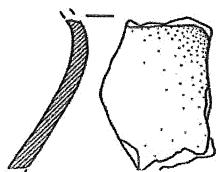

853



851



852

Biconici 1.1

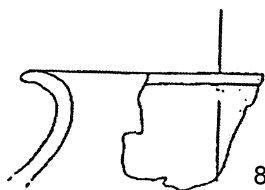

854



855

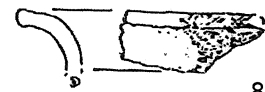

856

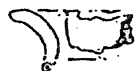

857

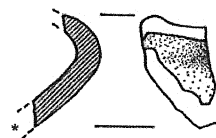

858

Biconici 1.2

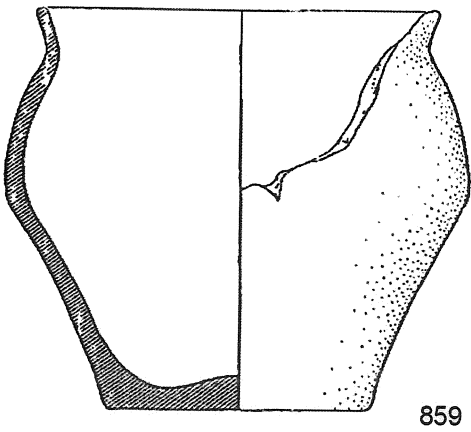

859

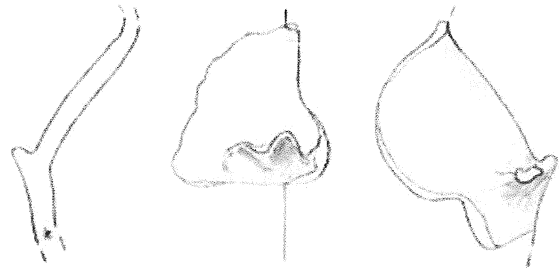

860

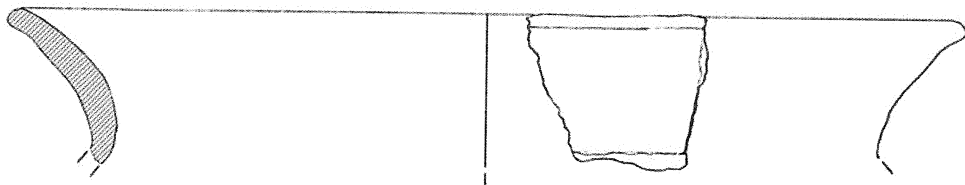

861

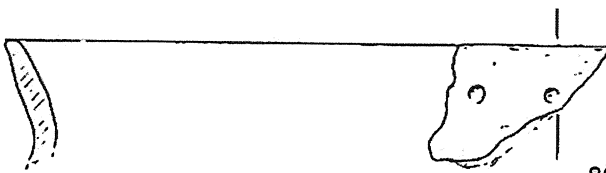

862

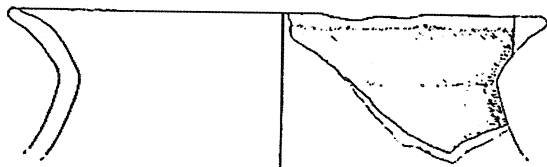

863



864



865

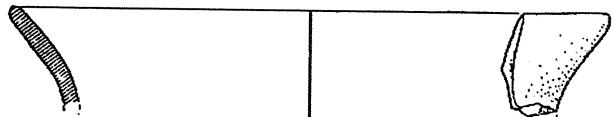

866

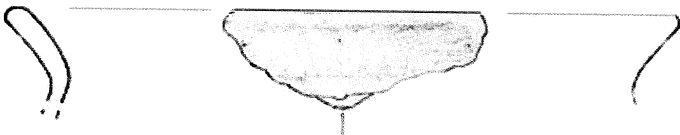

867



868



869



870

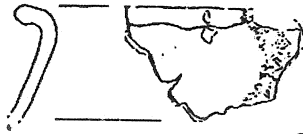

871

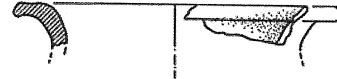

872

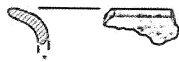

873



874

Biconici 2.2

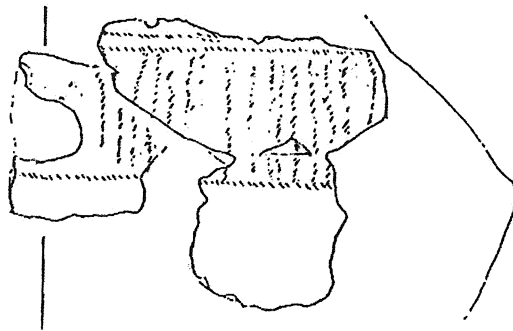
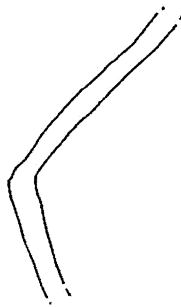

875

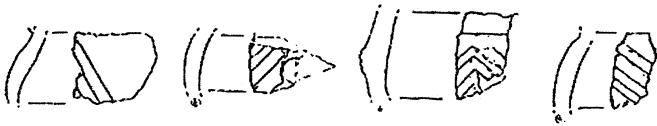

876

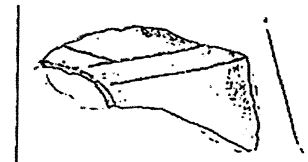

878

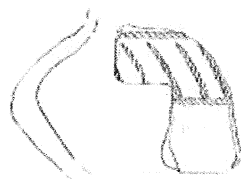

879

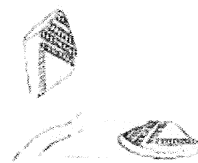

880

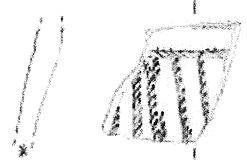

881

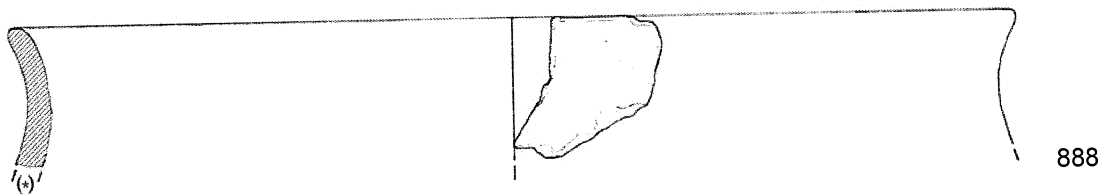
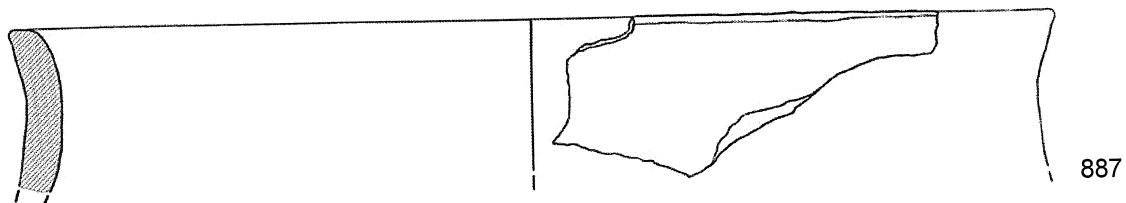
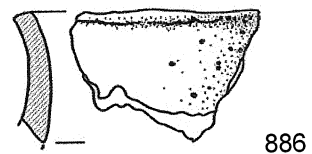
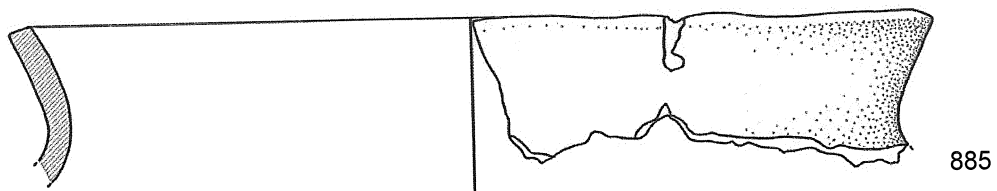
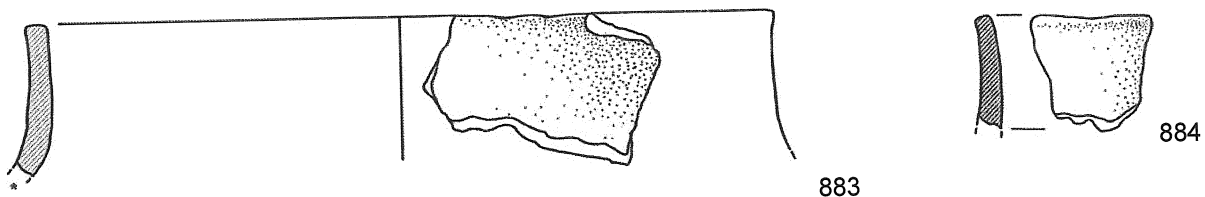
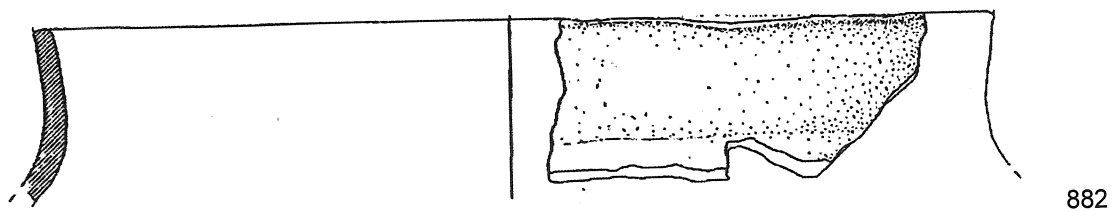

Doli 1.1

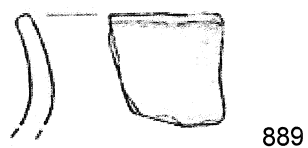

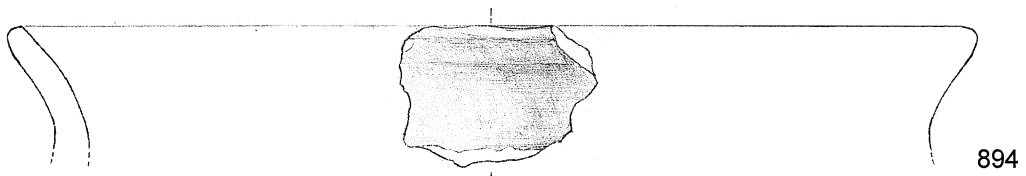
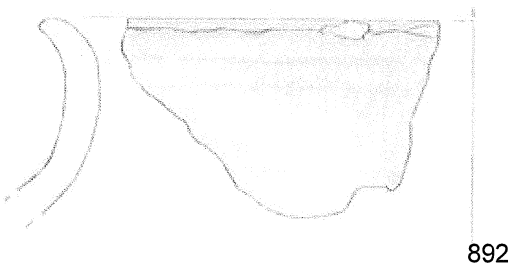
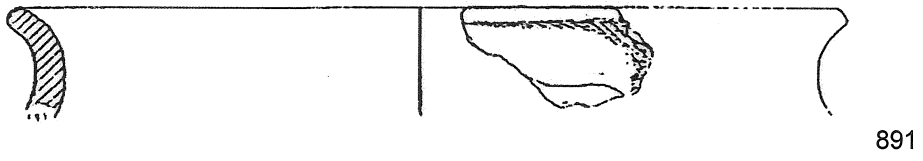
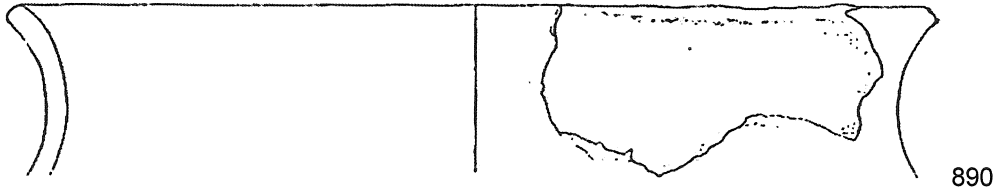

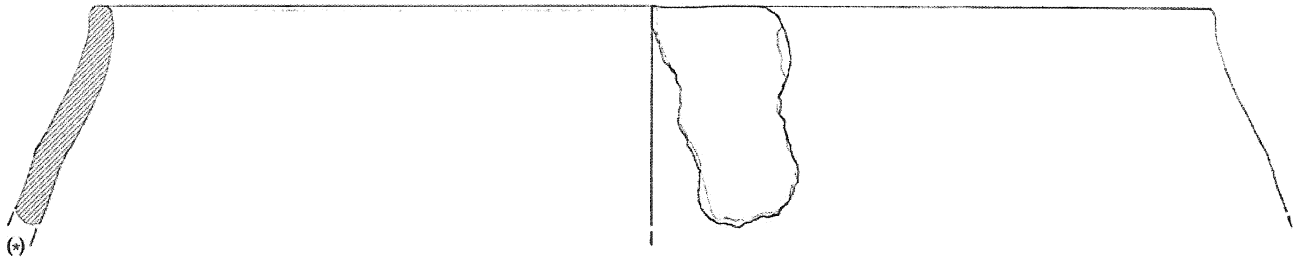

895

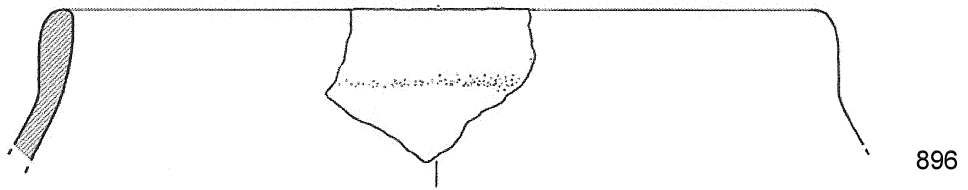

896

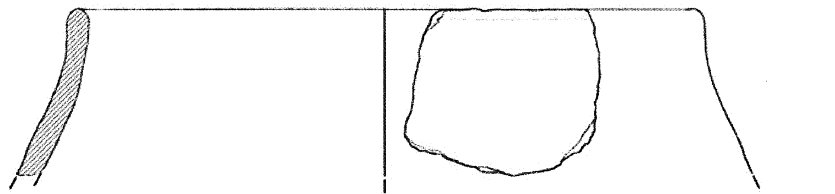

897

Doli 1.3.a

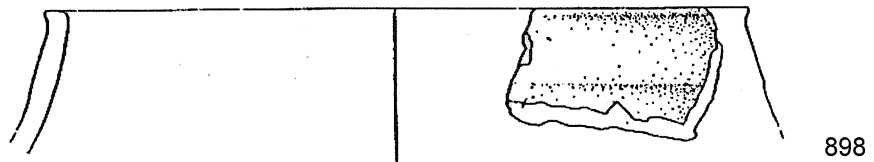

898

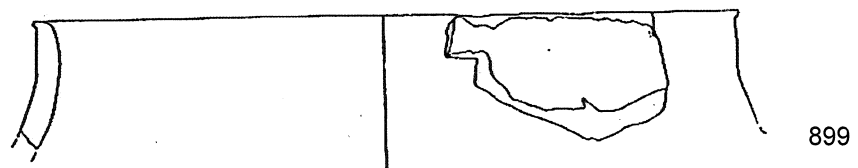

899

Doli 1.3.b

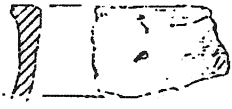

900



901



902



903



904

Doli 1.3.b

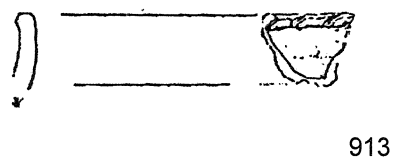
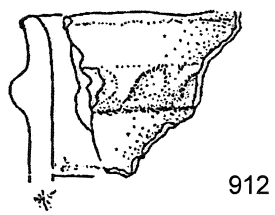
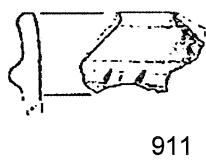
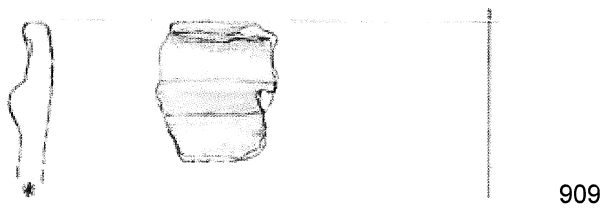
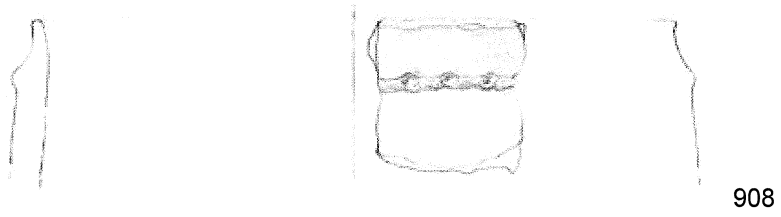
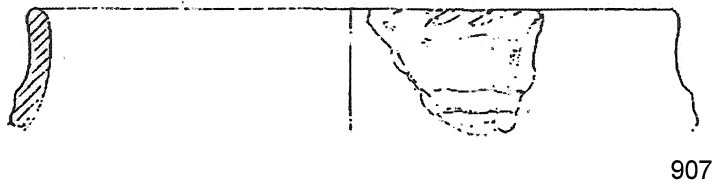
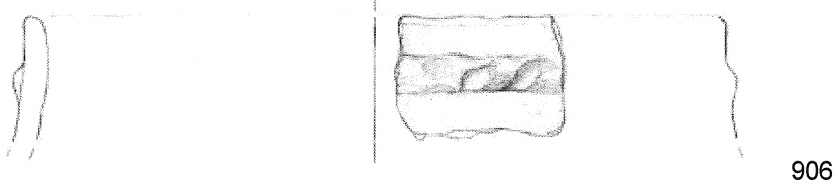
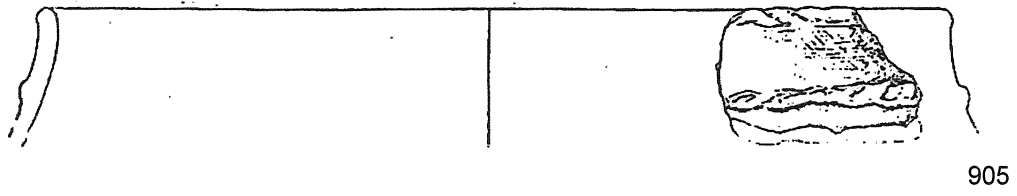

Doli 1.4.a

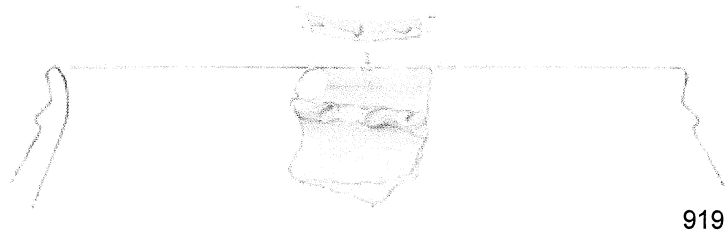
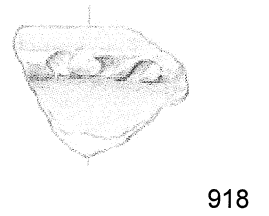
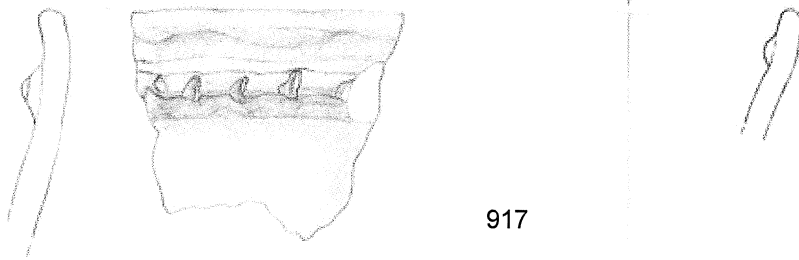
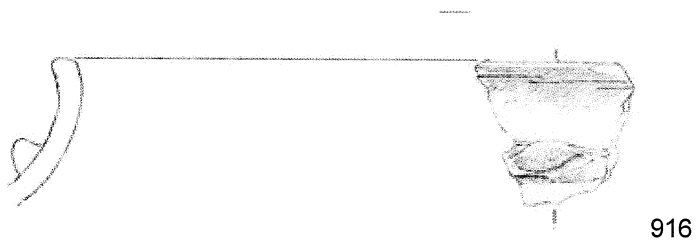
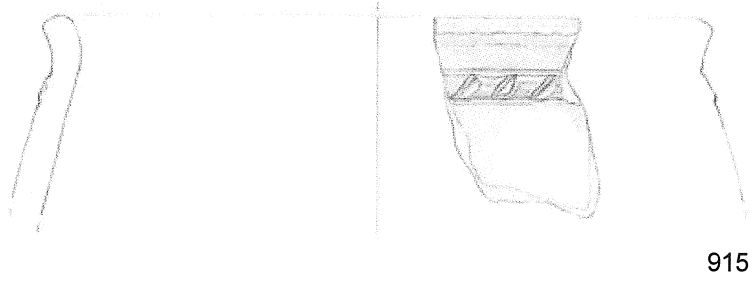
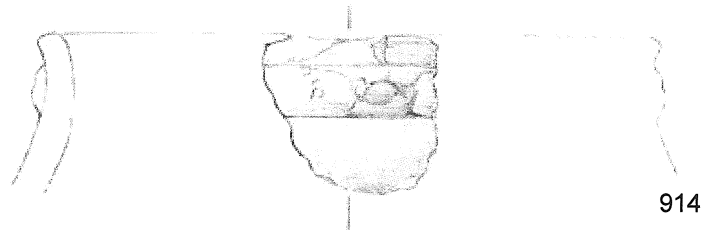

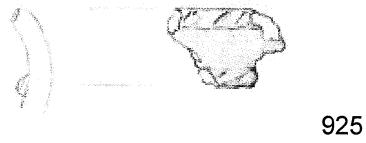
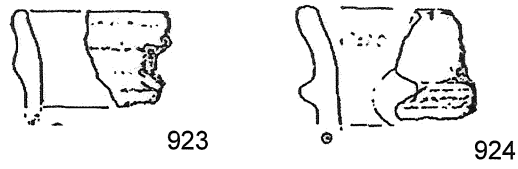
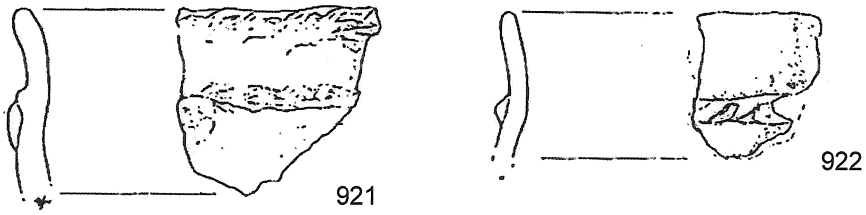
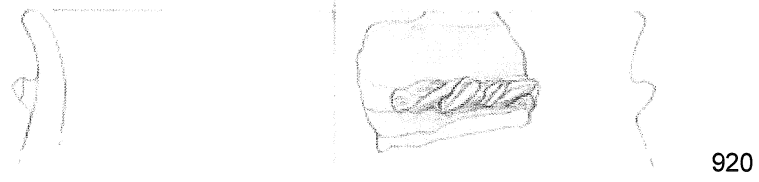

Doli 1.4.b

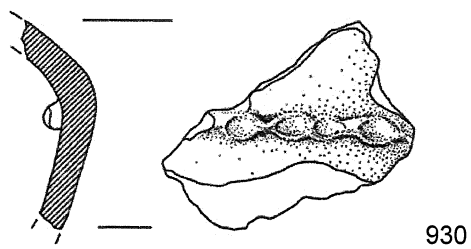
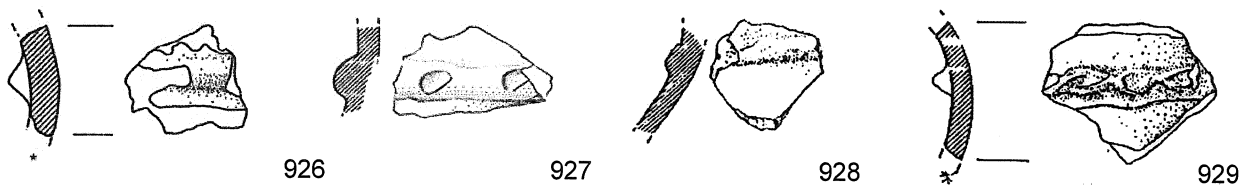

Frammenti genericamente
attribuibili a doli 1.4

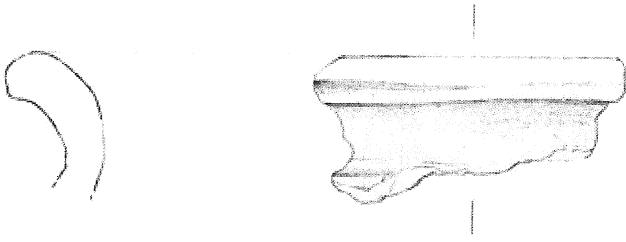

931

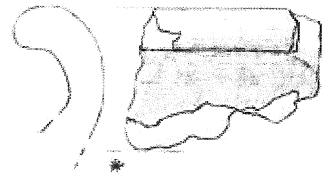

932

Doli 2.1.a

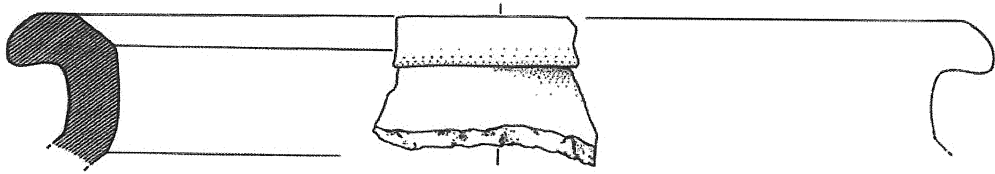

933

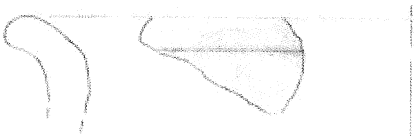

934

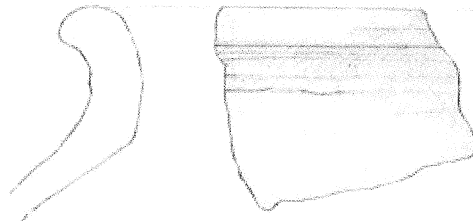

935



936



937

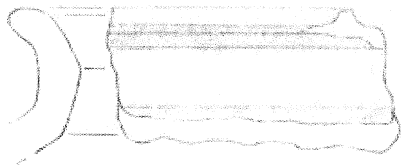

938

Doli 2.1.b

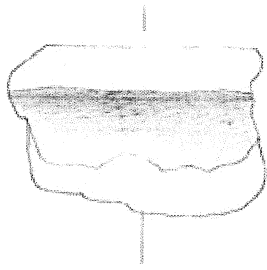
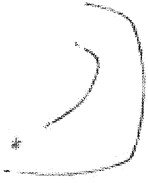

939

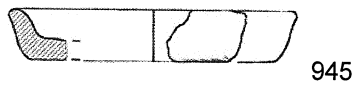
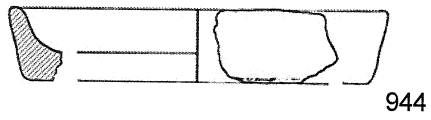

Teglie 1.1

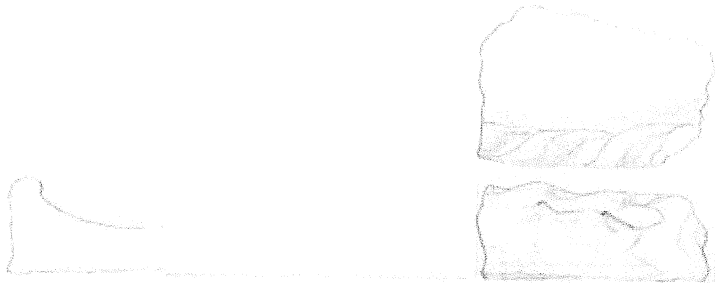

946

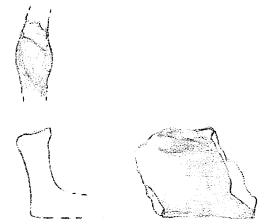

947



948



949

Teglie 1.2



950



951

Teglie 2.1

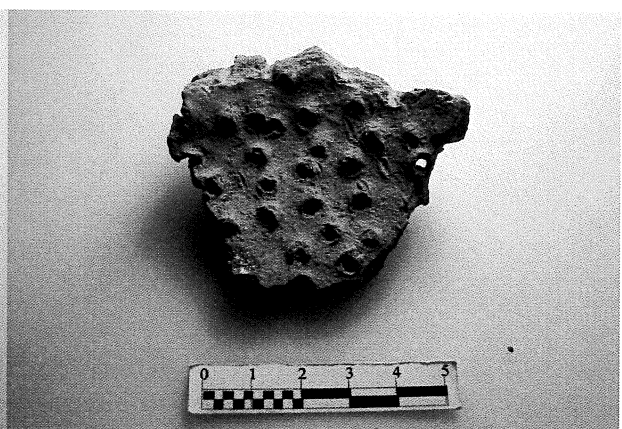
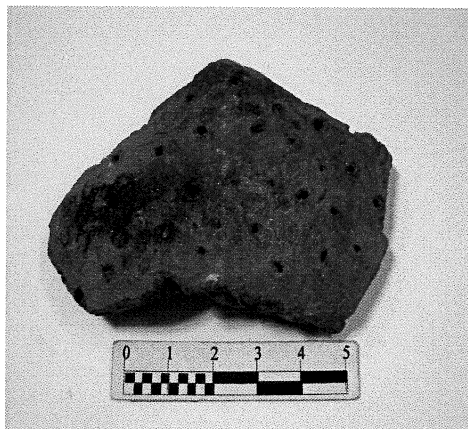
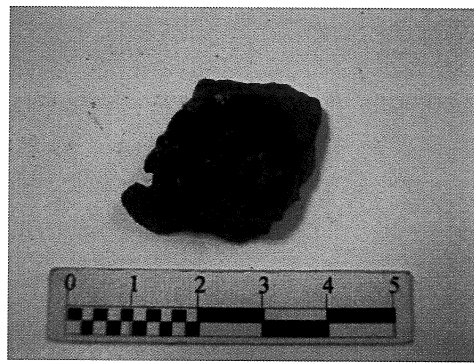
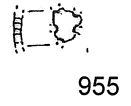
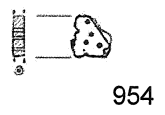
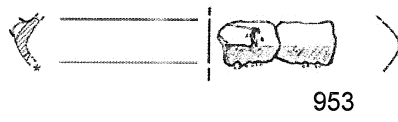
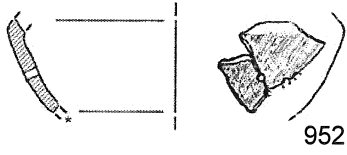

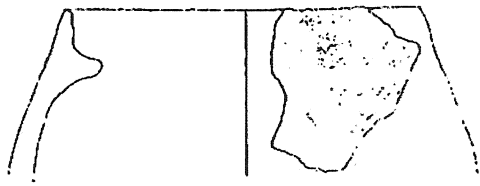

960

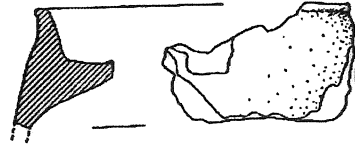

961

Vasi con listello interno 1.1

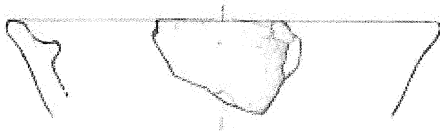

962



963

Vasi con listello interno 2.1

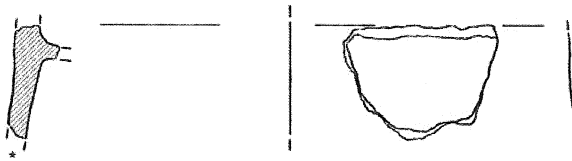

964



965

Vasi con listello interno (?)



966



967

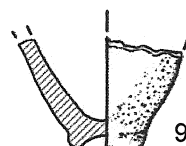

968



969

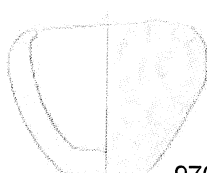

970



971



972



973



974



975

Beccucci

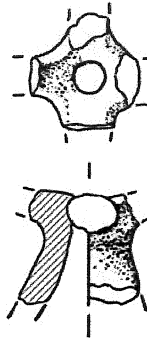

976

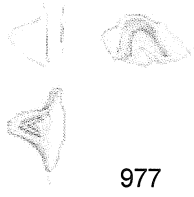

977



978

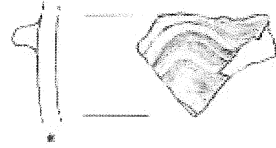

979



980

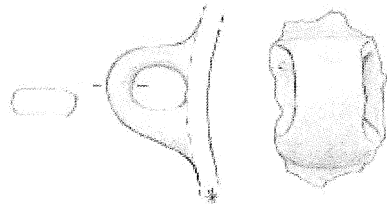

981

TAV. 111

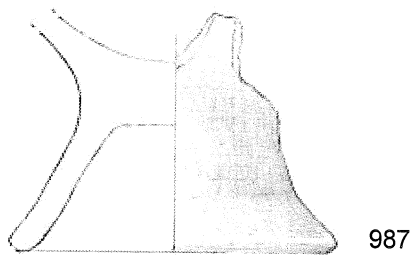
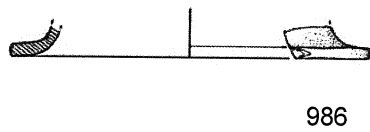
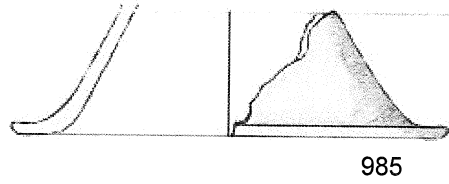
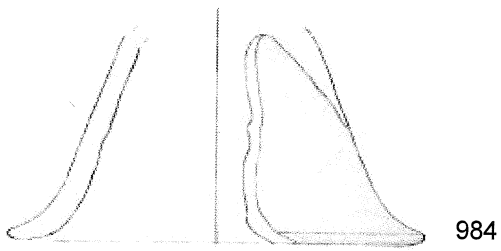
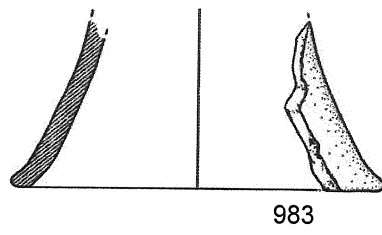
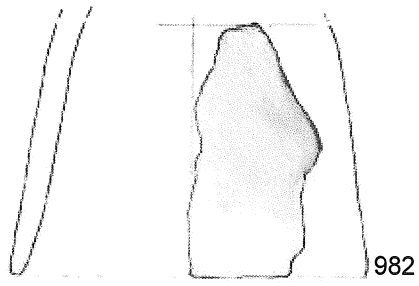

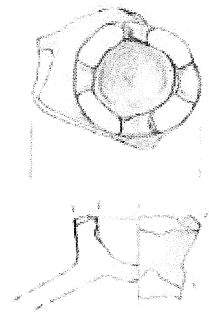
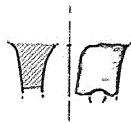
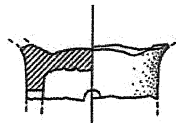
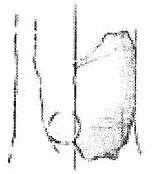
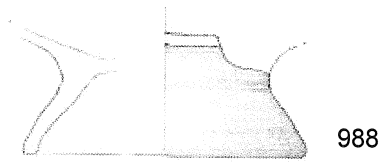

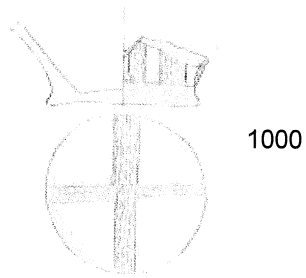
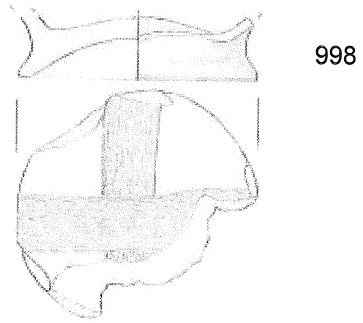
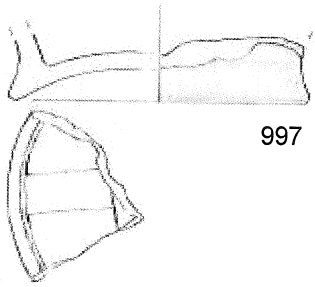
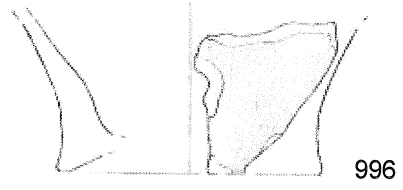

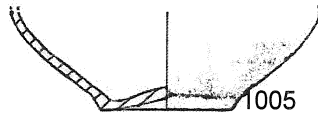
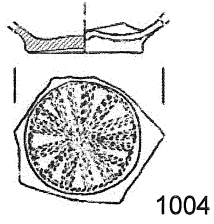
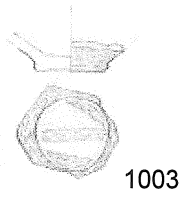

TAV. 115

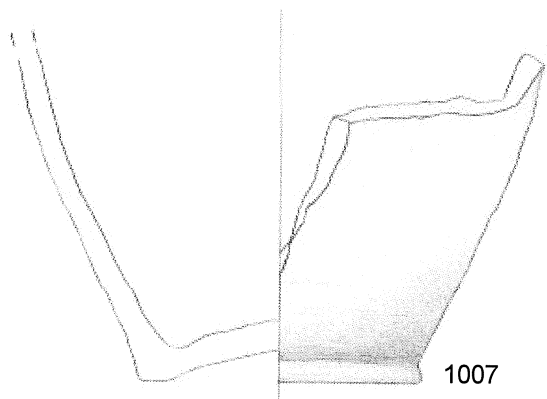
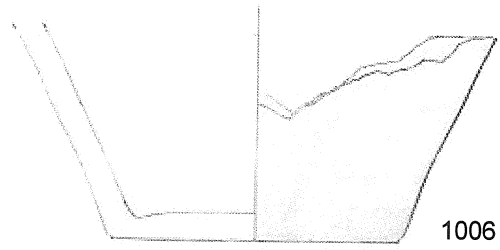

TAV. 116

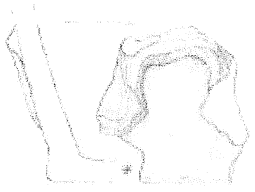

1008



1009

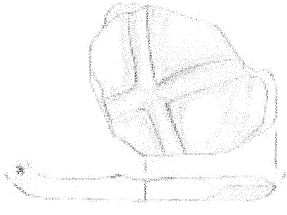

1010

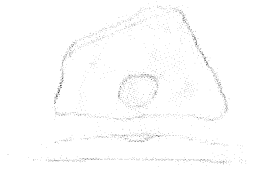

1011

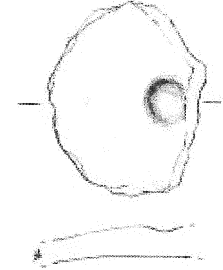

1012

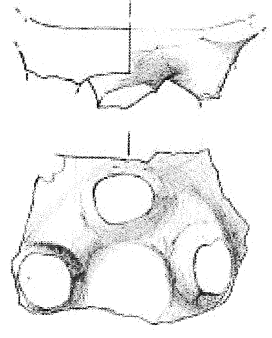

1013

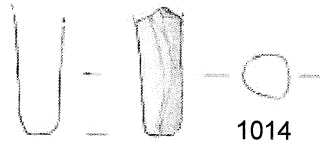

1014

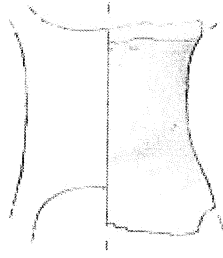

1015

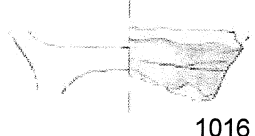

1016

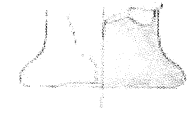

1017

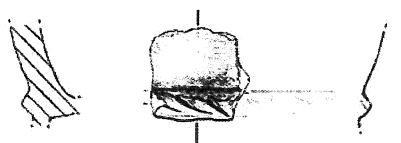

1018



1019

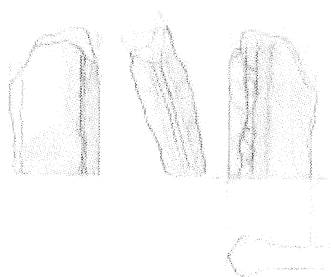

1020

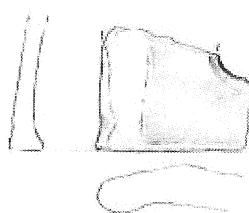

1021

Fornelli



1022

Rocchetto

PARETI DIAGNOSTICHE: STRALUCIDO

CZ 81



CZ 82



CZ 83



CZ 84



CZ 85



CZ 86



CZ 87



CZ 88



CZ 89



CZ 91



CZ 92



DA 81



DA 82



DA 82



DA 83



DA 84



DA 85



DA 87



DB 91



DB 92



settore Est - parte Est



settore Est - piano ribassato Est

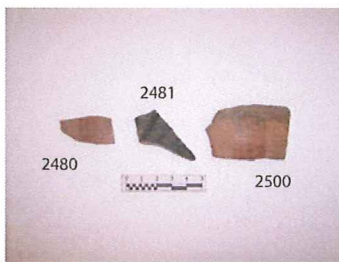

settore Est - parte III



settore Nord - nord - rimaneggiato



settore Nord - nord est



settore Nord - nord ovest



settore Ovest



Capanna Astragali



PARETI DIAGNOSTICHE: FASCE ROSSE/ROSSE E NERE

CZ 84



CZ 86



CZ 88



PARETI DIAGNOSTICHE: FASCE ROSSE/ROSSE E NERE

CZ 89



CZ 91



DA 85

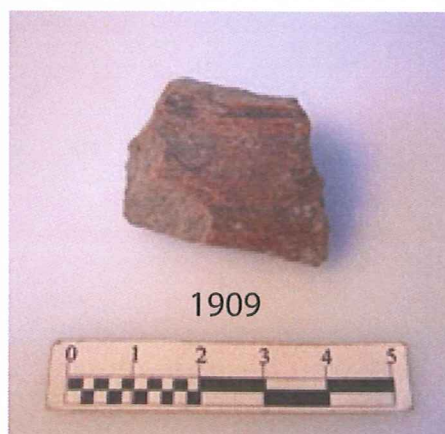

PARETI DIAGNOSTICHE: FASCE ROSSE/ROSSE E NERE

DA 86



DA 87



SETTORE EST
AREA EST - PARTE EST



PARETI DIAGNOSTICHE: FASCE ROSSE/ROSSE E NERE

SETTORE EST
AREA EST - PARTE I



SETTORE EST
AREA EST - PARTE III

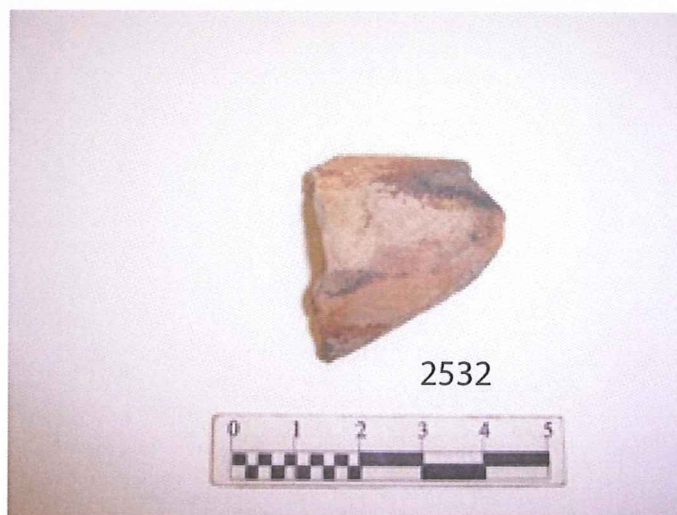

AREA CAPANNA ASTRAGALI
AREA CAPANNA GENERICO



PARETI DIAGNOSTICHE: BORCHIE DI BRONZO

CZ 83



557



CZ 86



737

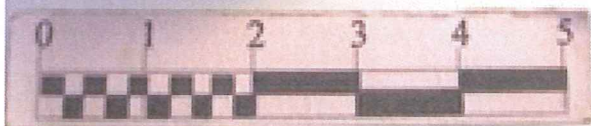

CZ 86



1473

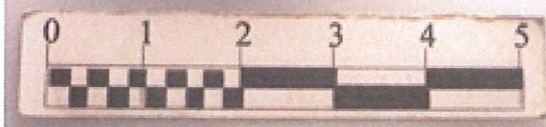

PARETI DIAGNOSTICHE: BORCHIE DI BRONZO

DA 82



SETTORE EST
ZONA EST - PARTE I



SETTORE NORD - NORD
RIMANEGGIATO



SETTORE NORD - NORD
RIMANEGGIATO



PARETI DIAGNOSTICHE: PETTINE

CZ 84



166

CZ 91



1093



1094



1094bis

SETTORE EST
ZONA EST - PARTE II



2849

PARETI DIAGNOSTICHE: PETTINE

SETTORE EST
ZONA EST - PARTE III



SETTORE NORD - NORD
RIMANEGGIATO



PARETI DIAGNOSTICHE: STAMPIGLIA

SETTORE EST - PARTE EST

SETTORE NORD - NORD OVEST
PULITURA PARETE TRINCEA DI RUSPA

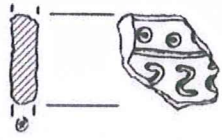

Ib 420

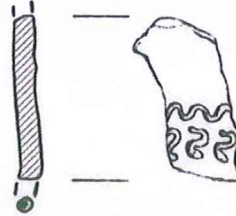

Ib 405

(scala 1:2)

TECNOLOGIA



