



UNIVERSITÀ
DEGLI STUDI
DI PADOVA

Sede Amministrativa: Università degli Studi di Padova

Dipartimento di Archeologia

SCUOLA DI DOTTORATO DI RICERCA IN STUDIO E CONSERVAZIONE DEI BENI ARCHEOLOGICI E
ARCHITETTONICI

INDIRIZZO: SCIENZE ARCHEOLOGICHE

XXII CICLO

LA RISORSA IDRICA NELLA CULTURA TERRAMARICOLA.
LE ACQUE TRA FUNZIONALITÀ E RITO

TAVOLE

Direttore della Scuola: Ch.mo Prof. Giovanni LEONARDI

Coordinatore d'indirizzo: Ch.mo Prof. Guido ROSADA

Supervisore: Ch.mo Prof. Giovanni LEONARDI

Dottoranda: Chiara PIZZI

INDICE DELLE TAVOLE

Tav. 1.....	Santa Rosa di Poviglio: US 2193
Tav. 2.....	Santa Rosa di Poviglio: US 2113
Tav. 3.....	Santa Rosa di Poviglio: US 2113
Tav. 4.....	Santa Rosa di Poviglio: US 2113
Tav. 5.....	Santa Rosa di Poviglio: US 2105
Tav. 6.....	Santa Rosa di Poviglio: US 2105
Tav. 7.....	Santa Rosa di Poviglio: US 2105
Tav. 8.....	Santa Rosa di Poviglio: US 2105
Tav. 9.....	Santa Rosa di Poviglio: US 2105
Tav. 10.....	Santa Rosa di Poviglio: US 2106
Tav. 11.....	Santa Rosa di Poviglio: US 2106
Tav. 12.....	Santa Rosa di Poviglio: US 2106
Tav. 13.....	Santa Rosa di Poviglio: US 2106
Tav. 14.....	Santa Rosa di Poviglio: US 2106
Tav. 15.....	Santa Rosa di Poviglio: US 2106
Tav. 16.....	Santa Rosa di Poviglio: US 2106
Tav. 17.....	Santa Rosa di Poviglio: US 2106
Tav. 18.....	Santa Rosa di Poviglio: US 2106
Tav. 19.....	Santa Rosa di Poviglio: US 2106
Tav. 20.....	Santa Rosa di Poviglio: US 2106
Tav. 21.....	Santa Rosa di Poviglio: US 2106
Tav. 22.....	Santa Rosa di Poviglio: US 2106
Tav. 23.....	Santa Rosa di Poviglio: US 2106
Tav. 24.....	Santa Rosa di Poviglio: US 2106
Tav. 25.....	Santa Rosa di Poviglio: US 2106
Tav. 26.....	Santa Rosa di Poviglio: US 2106
Tav. 27.....	Santa Rosa di Poviglio: US 1860
Tav. 28.....	Santa Rosa di Poviglio: US 1860
Tav. 29.....	Santa Rosa di Poviglio: US 1860
Tav. 30.....	Santa Rosa di Poviglio: US 1885
Tav. 31.....	Santa Rosa di Poviglio: US 1885
Tav. 32.....	Santa Rosa di Poviglio: US 1333
Tav. 33.....	Santa Rosa di Poviglio: US 1336
Tav. 34.....	Santa Rosa di Poviglio: US 1336
Tav. 35.....	Santa Rosa di Poviglio: US 1336
Tav. 36.....	Santa Rosa di Poviglio: US 1448
Tav. 37.....	Santa Rosa di Poviglio: US 1548
Tav. 38.....	Santa Rosa di Poviglio: US 1548
Tav. 39.....	Santa Rosa di Poviglio: US 1548
Tav. 40.....	Santa Rosa di Poviglio: US 1548
Tav. 41.....	Santa Rosa di Poviglio: US 1548
Tav. 42.....	Santa Rosa di Poviglio: US 1548
Tav. 43.....	Santa Rosa di Poviglio: US 1548
Tav. 44.....	Santa Rosa di Poviglio: US 1548
Tav. 45.....	Santa Rosa di Poviglio: US 1548
Tav. 46.....	Santa Rosa di Poviglio: US 1548
Tav. 47.....	Santa Rosa di Poviglio: US 1548
Tav. 48.....	Santa Rosa di Poviglio: UUSS 1712-5340
Tav. 49.....	Santa Rosa di Poviglio: US 1426
Tav. 50.....	Santa Rosa di Poviglio: US 1426
Tav. 51.....	Santa Rosa di Poviglio: US 5223
Tav. 52.....	Santa Rosa di Poviglio: US 5245
Tav. 53.....	Santa Rosa di Poviglio: US 5165
Tav. 54.....	Santa Rosa di Poviglio: US 5165
Tav. 55.....	Santa Rosa di Poviglio: US 5165
Tav. 56.....	Santa Rosa di Poviglio: US 5165
Tav. 57.....	Santa Rosa di Poviglio: US 5165

Tav. 58Santa Rosa di Poviglio: US 5165
Tav. 59Santa Rosa di Poviglio: US 5165
Tav. 60Santa Rosa di Poviglio: US 5165
Tav. 61Santa Rosa di Poviglio: US 5165
Tav. 62Santa Rosa di Poviglio: US 5167
Tav. 63Santa Rosa di Poviglio: US 5167
Tav. 64Santa Rosa di Poviglio: US 5600
Tav. 65Santa Rosa di Poviglio: US 5600
Tav. 66Santa Rosa di Poviglio: US 5622
Tav. 67Santa Rosa di Poviglio: US 5622
Tav. 68Santa Rosa di Poviglio: US 5622
Tav. 69Santa Rosa di Poviglio: US 5622
Tav. 70Santa Rosa di Poviglio: US 5776
Tav. 71Santa Rosa di Poviglio: US 1879
Tav. 72Santa Rosa di Poviglio: US 2629 e manufatti in bronzo

Tav. 73Santa Rosa di Poviglio: US 1049
Tav. 74Santa Rosa di Poviglio: US 1049
Tav. 75Santa Rosa di Poviglio: US 1049
Tav. 76Santa Rosa di Poviglio: US 1049
Tav. 77Santa Rosa di Poviglio: US 1049
Tav. 78Santa Rosa di Poviglio: US 1049
Tav. 79Santa Rosa di Poviglio: US 1049
Tav. 80Santa Rosa di Poviglio: US 1049
Tav. 81Santa Rosa di Poviglio: US 1049
Tav. 82Santa Rosa di Poviglio: US 1049
Tav. 83Santa Rosa di Poviglio: US 1049
Tav. 84Santa Rosa di Poviglio: US 1049
Tav. 85Santa Rosa di Poviglio: US 1049
Tav. 86Santa Rosa di Poviglio: US 1049
Tav. 87Santa Rosa di Poviglio: US 1049
Tav. 88Santa Rosa di Poviglio: US 1049
Tav. 89Santa Rosa di Poviglio: US 1049
Tav. 90Santa Rosa di Poviglio: US 1049
Tav. 91Santa Rosa di Poviglio: US 1049
Tav. 92Santa Rosa di Poviglio: US 1049
Tav. 93Santa Rosa di Poviglio: US 1049
Tav. 94Santa Rosa di Poviglio: US 1049
Tav. 95Santa Rosa di Poviglio: US 1049
Tav. 96Santa Rosa di Poviglio: US 1049
Tav. 97Santa Rosa di Poviglio: US 1049

Tav. 98Santa Rosa di Poviglio: US 5175
Tav. 99Santa Rosa di Poviglio: US 5175
Tav. 100Santa Rosa di Poviglio: US 5175
Tav. 101Santa Rosa di Poviglio: US 5175
Tav. 102Santa Rosa di Poviglio: US 5175
Tav. 103Santa Rosa di Poviglio: US 5175
Tav. 104Santa Rosa di Poviglio: US 5175
Tav. 105Santa Rosa di Poviglio: US 5175
Tav. 106Santa Rosa di Poviglio: US 5175
Tav. 107Santa Rosa di Poviglio: US 5175
Tav. 108Santa Rosa di Poviglio: US 5175
Tav. 109Santa Rosa di Poviglio: US 5175
Tav. 110Santa Rosa di Poviglio: US 5175
Tav. 111Santa Rosa di Poviglio: US 5175
Tav. 112Santa Rosa di Poviglio: US 5175
Tav. 113Santa Rosa di Poviglio: US 5175
Tav. 114Santa Rosa di Poviglio: US 5175
Tav. 115Santa Rosa di Poviglio: US 5175
Tav. 116Santa Rosa di Poviglio: US 5175
Tav. 117Santa Rosa di Poviglio: US 5175

- Tav. 118**.....Santa Rosa di Poviglio: US 5175
Tav. 119.....Santa Rosa di Poviglio: US 5175
Tav. 120.....Santa Rosa di Poviglio: US 5175
Tav. 121.....Santa Rosa di Poviglio: US 5175
Tav. 122.....Santa Rosa di Poviglio: US 5175
Tav. 123.....Santa Rosa di Poviglio: US 5175
Tav. 124.....Santa Rosa di Poviglio: US 5175
Tav. 125.....Santa Rosa di Poviglio: US 5175
Tav. 126.....Santa Rosa di Poviglio: US 5175
Tav. 127.....Santa Rosa di Poviglio: US 5175
Tav. 128.....Santa Rosa di Poviglio: US 5175
Tav. 129.....Santa Rosa di Poviglio: US 5175
Tav. 130.....Santa Rosa di Poviglio: US 5175
Tav. 131.....Santa Rosa di Poviglio: US 5175
Tav. 132.....Santa Rosa di Poviglio: US 5175
Tav. 133.....Santa Rosa di Poviglio: US 5175
Tav. 134.....Santa Rosa di Poviglio: US 5175
Tav. 135.....Santa Rosa di Poviglio: US 5175
Tav. 136.....Santa Rosa di Poviglio: US 5175
Tav. 137.....Santa Rosa di Poviglio: US 5175
Tav. 138.....Santa Rosa di Poviglio: US 5175
- Tav. 139**.....Santa Rosa di Poviglio: US 5974
Tav. 140.....Santa Rosa di Poviglio: US 5974
Tav. 141.....Santa Rosa di Poviglio: US 6089
Tav. 142.....Santa Rosa di Poviglio: US 5993
Tav. 143.....Santa Rosa di Poviglio: US 6001
Tav. 144.....Santa Rosa di Poviglio: strutture del centro fossato
Tav. 145.....Santa Rosa di Poviglio: strutture del centro fossato
Tav. 146.....Santa Rosa di Poviglio: strutture del centro fossato
Tav. 147.....Santa Rosa di Poviglio: strutture della campagna interna
Tav. 148.....Santa Rosa di Poviglio: strutture della campagna interna
Tav. 149.....Santa Rosa di Poviglio: area tra le due risalite
Tav. 150.....Santa Rosa di Poviglio: area del canale adduttore
Tav. 151.....Santa Rosa di Poviglio: area del canale adduttore
Tav. 152.....Santa Rosa di Poviglio: area del canale adduttore
Tav. 153.....Santa Rosa di Poviglio: area del canale adduttore
Tav. 154.....Santa Rosa di Poviglio: area del canale adduttore
Tav. 155.....Santa Rosa di Poviglio: strutture della campagna esterna
Tav. 156.....Santa Rosa di Poviglio: recipienti interi
Tav. 157.....Santa Rosa di Poviglio: recipienti interi
- Tav. 158**.....a) Case Cocconi; b) Buco del Signore-La Favorita
Tav. 159.....Buco del Signore-La Favorita
Tav. 160.....Buco del Signore-La Favorita
Tav. 161.....Cortile San Martino
Tav. 162.....Cortile San Martino
Tav. 163.....Cortile San Martino
Tav. 164.....Cortile San Martino
Tav. 165.....Cortile San Martino
Tav. 166.....Cortile San Martino
Tav. 167.....Cortile San Martino
- Tav. 168**.....Noceto La Torretta: vasi interi UUSS 89, 90, 87, 87a
Tav. 169.....Noceto La Torretta: vasi interi US 87a
Tav. 170.....Noceto La Torretta: vasi interi US 87a
Tav. 171.....Noceto La Torretta: vasi interi US 87a
Tav. 172.....Noceto La Torretta: vasi interi US 87a
Tav. 173.....Noceto La Torretta: vasi interi UUSS 84, 85, 82, 91, 81 sotto 81c, 81d-e
Tav. 174.....Noceto La Torretta: vasi interi UUSS 81 sotto 81c, 81c
Tav. 175.....Noceto La Torretta: vasi interi US 81c
Tav. 176.....Noceto La Torretta: vasi interi US 81c

Tav. 177.....Noceto La Torretta: vasi interi UUSS 81c, 80, 31
Tav. 178.....Noceto La Torretta: vasi interi US 66base
Tav. 179.....Noceto La Torretta: vasi interi UUSS 66, 66α, 28
Tav. 180.....Noceto La Torretta: vasi interi UUSS 197, 5002Fb, 5017, 177, 5003
Tav. 181.....Noceto La Torretta: vasi interi UUSS 5002 e correlate, 5001

Tav. 182.....Noceto La Torretta: frammenti UUSS 89 e 89a
Tav. 183.....Noceto La Torretta: frammenti UUSS 87base, 87a, 87
Tav. 184.....Noceto La Torretta: frammenti US 87
Tav. 185.....Noceto La Torretta: frammenti US 87
Tav. 186.....Noceto La Torretta: frammenti US 87
Tav. 187.....Noceto La Torretta: frammenti US 87
Tav. 188.....Noceto La Torretta: frammenti US 87
Tav. 189.....Noceto La Torretta: frammenti UUSS 87, 85
Tav. 190.....Noceto La Torretta: frammenti US 85
Tav. 191.....Noceto La Torretta: frammenti UUSS 85, 141
Tav. 192.....Noceto La Torretta: frammenti UUSS 141, 84
Tav. 193.....Noceto La Torretta: frammenti UUSS 84, 83
Tav. 194.....Noceto La Torretta: frammenti UUSS 81, 80
Tav. 195.....Noceto La Torretta: frammenti US 80
Tav. 196.....Noceto La Torretta: frammenti UUSS 80, 66β
Tav. 197.....Noceto La Torretta: frammenti UUSS 66β, 66α
Tav. 198.....Noceto La Torretta: frammenti US 66α
Tav. 199.....Noceto La Torretta: frammenti US 66α
Tav. 200.....Noceto La Torretta: frammenti UUSS 31, 28b
Tav. 201.....Noceto La Torretta: frammenti UUSS 28b, 28a
Tav. 202.....Noceto La Torretta: frammenti US 5003b
Tav. 203.....Noceto La Torretta: frammenti UUSS 5007, 5004
Tav. 204.....Noceto La Torretta: frammenti UUSS 197, 5020
Tav. 205.....Noceto La Torretta: frammenti US 5020
Tav. 206.....Noceto La Torretta: frammenti UUSS 5017, 5017b
Tav. 207.....Noceto La Torretta: frammenti US 5017
Tav. 208.....Noceto La Torretta: frammenti US 5017
Tav. 209.....Noceto La Torretta: frammenti UUSS 5017, 177
Tav. 210.....Noceto La Torretta: frammenti UUSS 5002 e correlate

Tav. 211.....Noceto-Cantiere Abruzzese
Tav. 212.....Noceto-Cantiere Turrà & Franzè
Tav. 213.....Noceto-Cantiere Paglia Sud
Tav. 214.....Noceto-Cantiere Bonifica
Tav. 215.....Noceto-Cantiere Bonifica
Tav. 216.....Noceto-Cantiere Bellicchi
Tav. 217.....Noceto-Cantiere Bellicchi
Tav. 218.....Noceto-Cantiere Bellicchi
Tav. 219.....Noceto-Cantiere Bellicchi

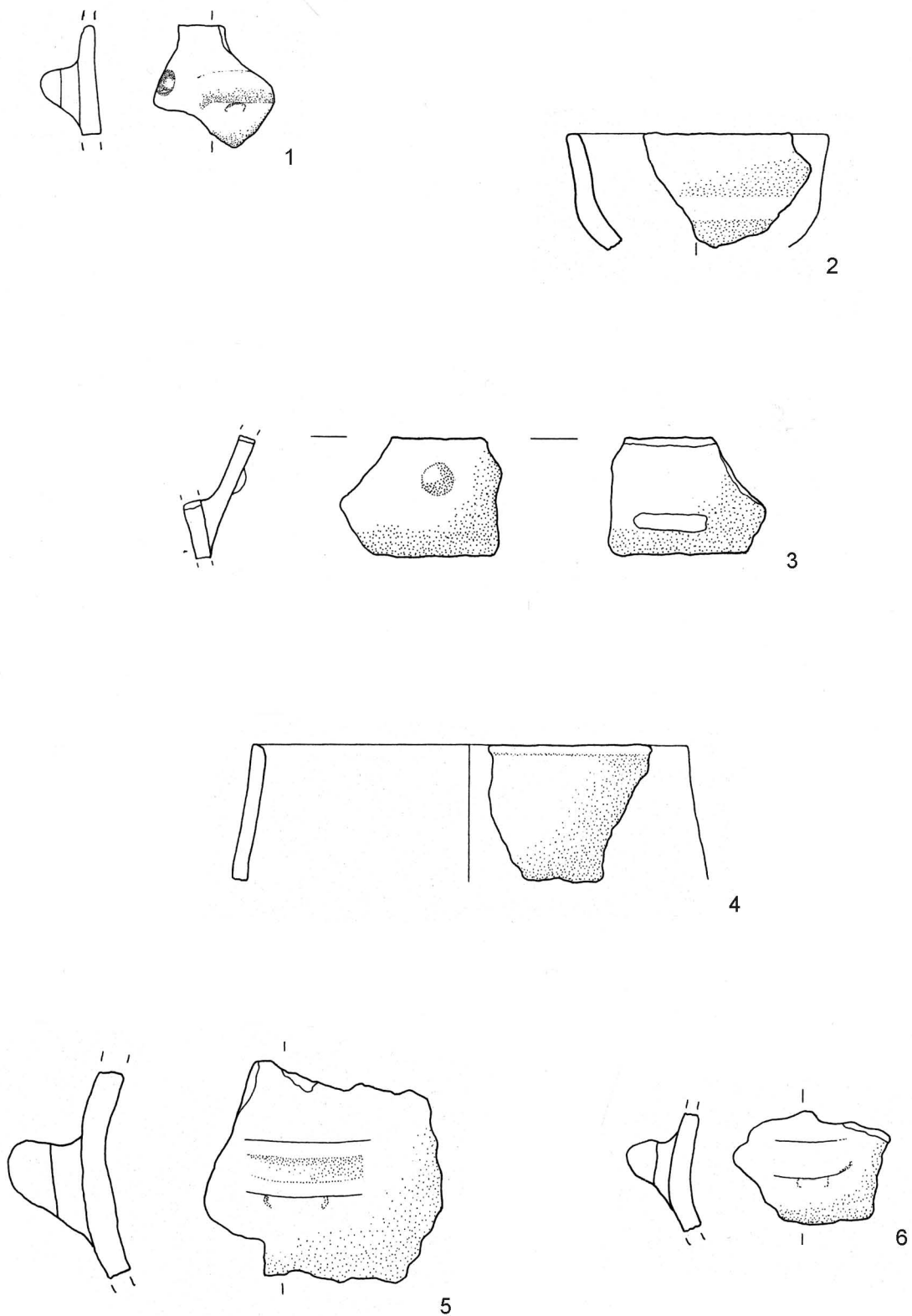

Tav. 1 - Santa Rosa di Poviglio: materiali ceramici provenienti dal pozzo US 2193; 1) da US 2199; 2-6) da US 2198 (scala 1:3).

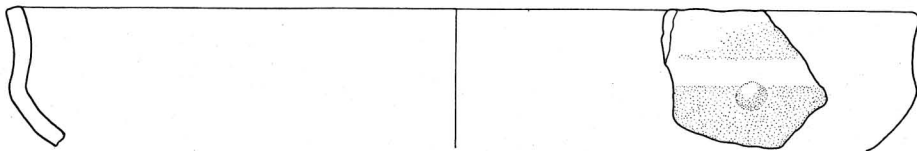

1

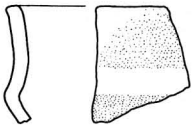

2

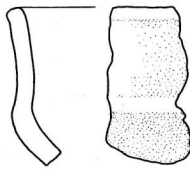

3

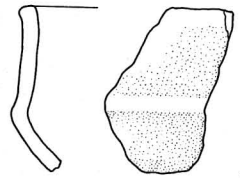

4

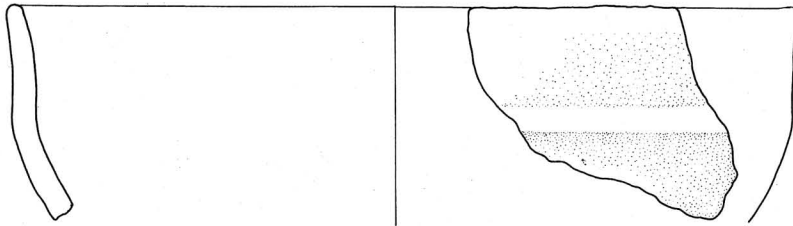

5

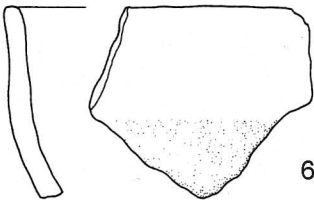

6

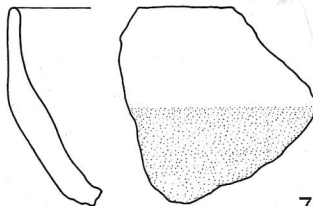

7

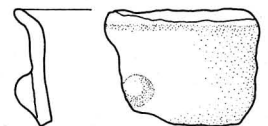

8

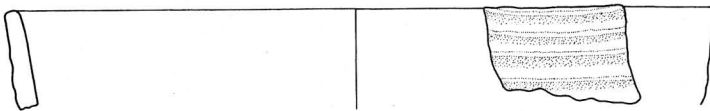

9

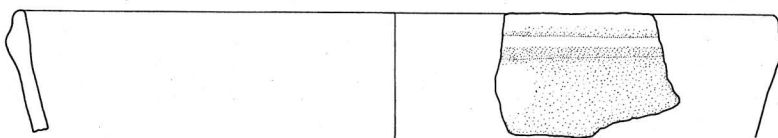

10

Tav. 2 - Santa Rosa di Poviglio: materiali ceramici provenienti dal pozzo US 2113; 1-10) da US 2129 (scala 1:3).

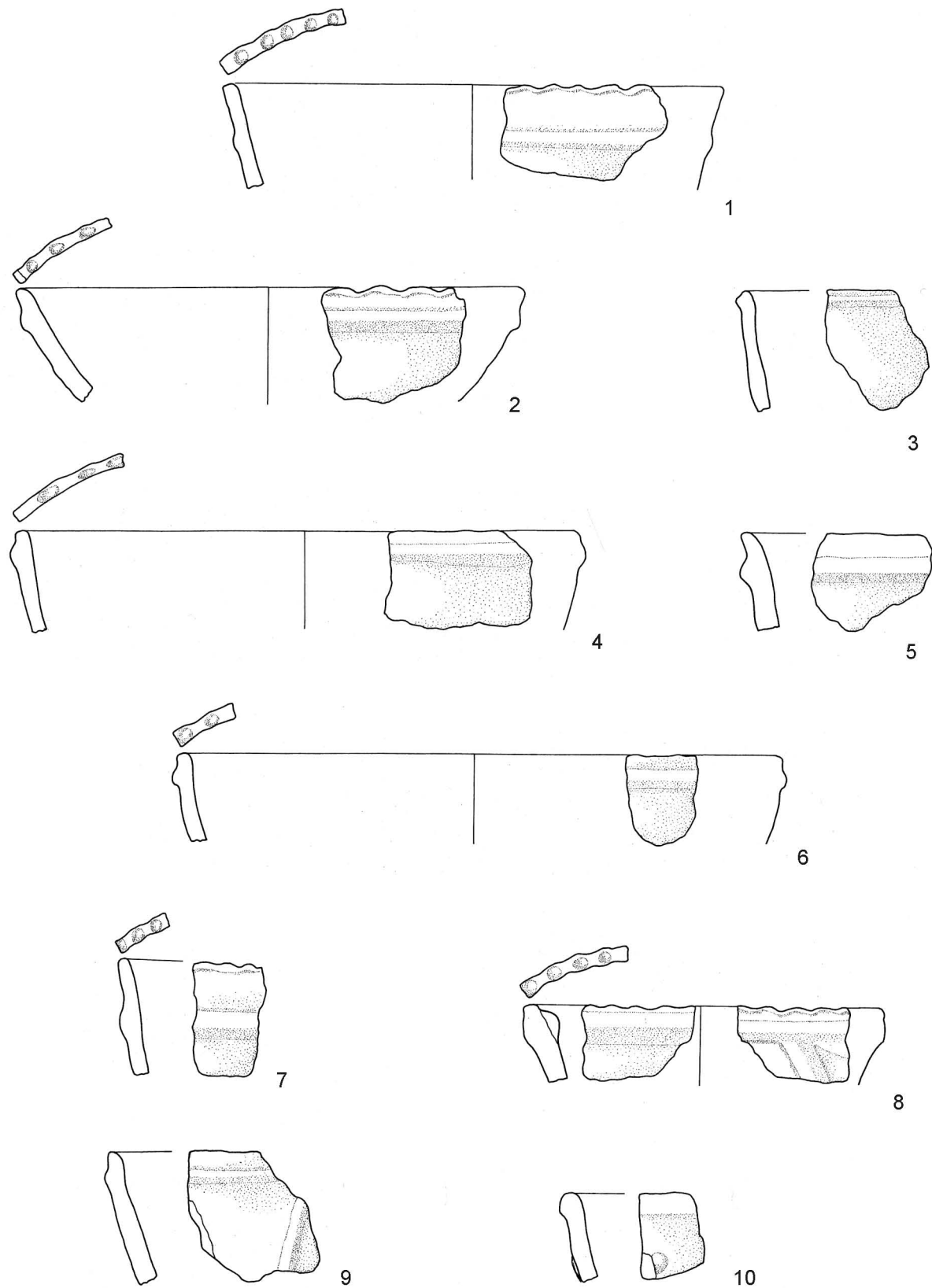

Tav. 3 - Santa Rosa di Poviglio: materiali ceramici provenienti dal pozzo US 2113; 1-10) da US 2129 (scala 1:3).

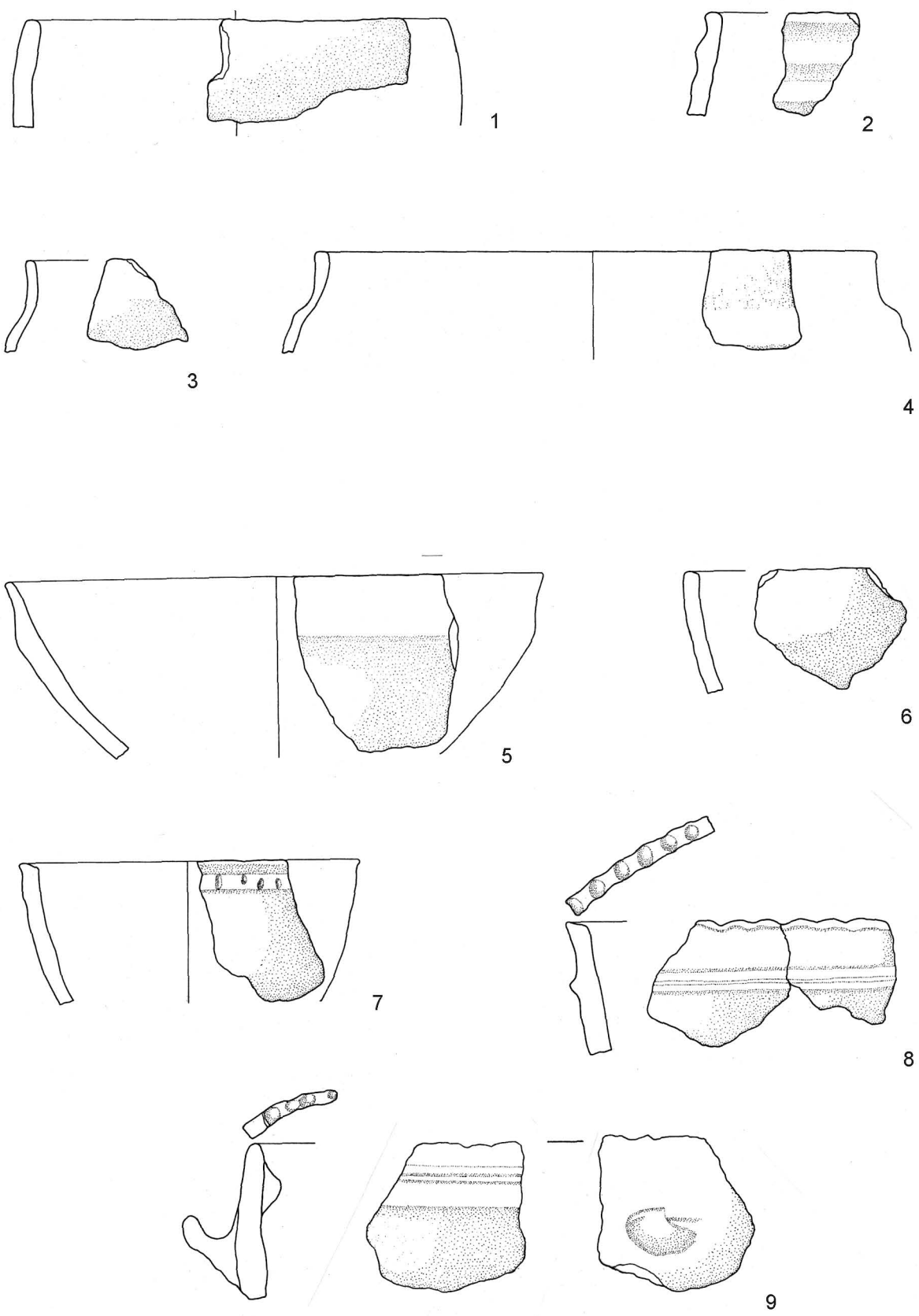

Tav. 4 - Santa Rosa di Poviglio: materiali ceramici provenienti dal pozzo US 2113; 1-4) da US 2129; 5-9) da US 2112 (scala 1:3).

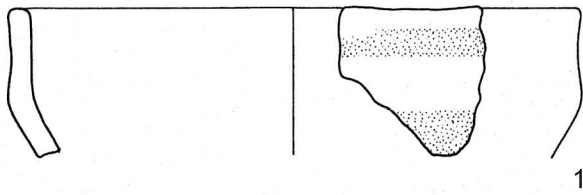

1

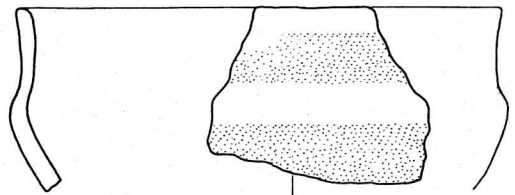

2

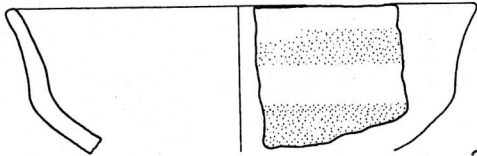

3

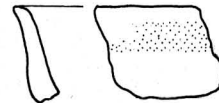

4

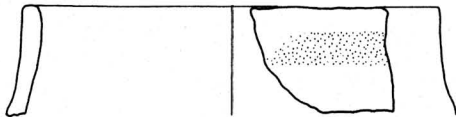

5

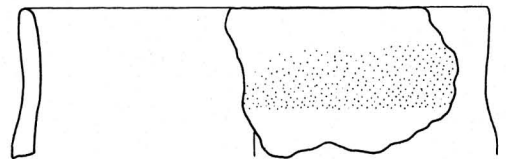

6

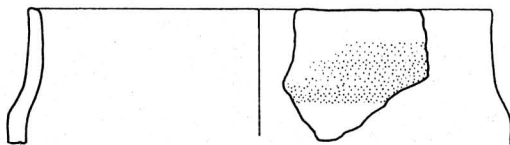

7

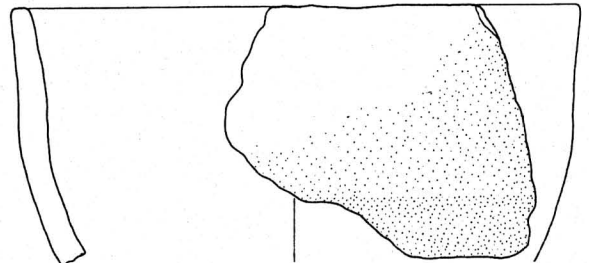

8

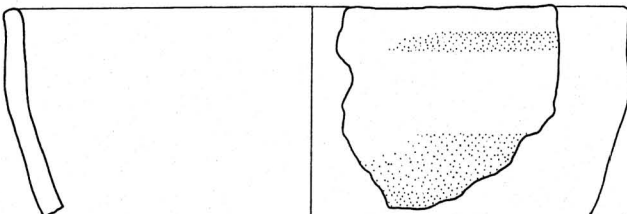

9

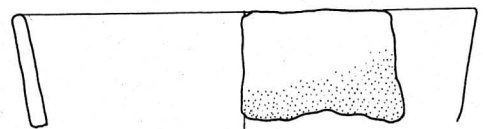

10

Tav. 5 - Santa Rosa di Poviglio: materiali ceramici del pozzo US 2105; 1-10) da US 2189=200 (scala 1:3).

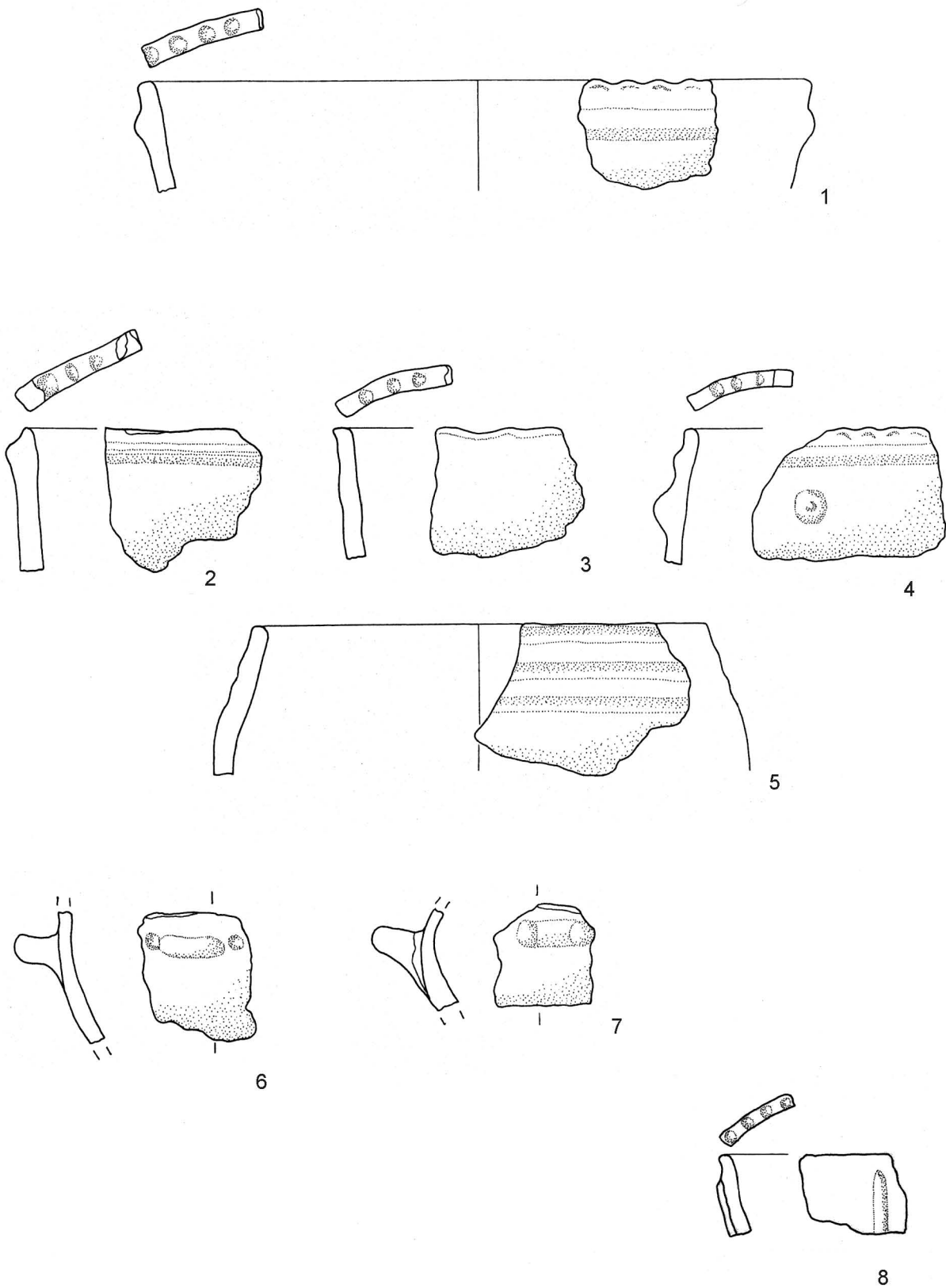

Tav. 6 - Santa Rosa di Poviglio: materiali ceramici provenienti dal pozzo US 2105; 1-7) da US 2189=200; 8) da US 2167 (scala 1:3).

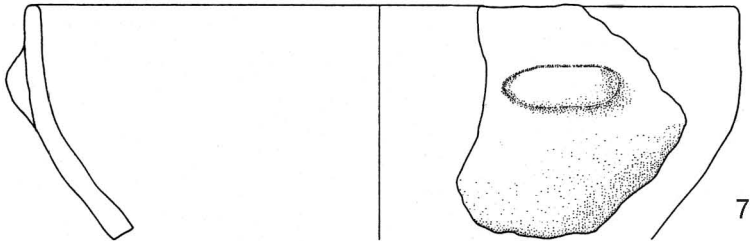
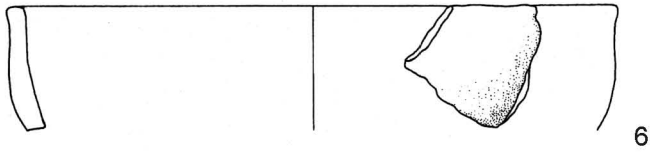
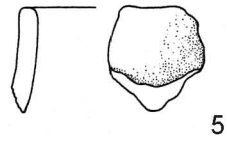
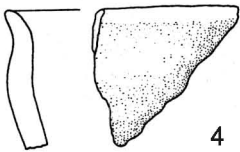
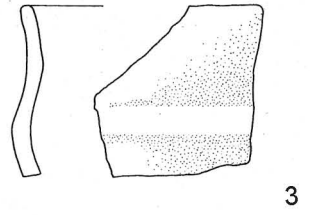
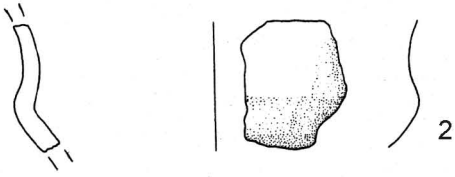
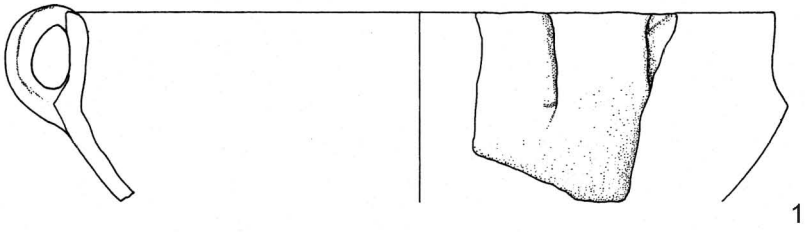

Tav. 7 - Santa Rosa di Poviglio: materiali ceramici provenienti dal pozzo US 2105; 1-7) da US 2141 (scala 1:3).

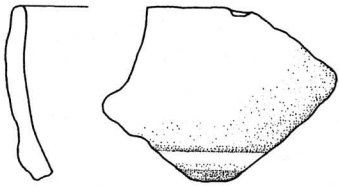

1

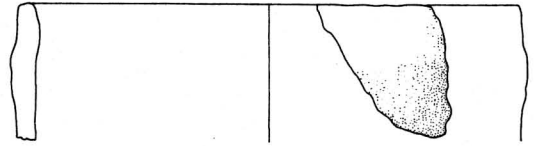

2

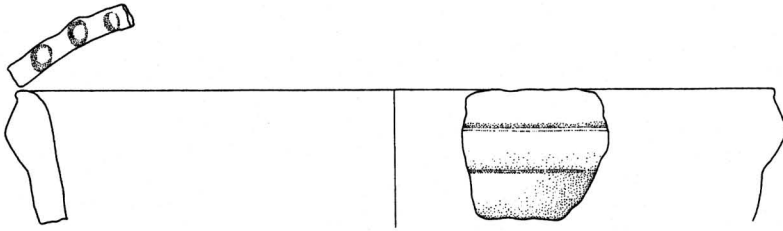

3

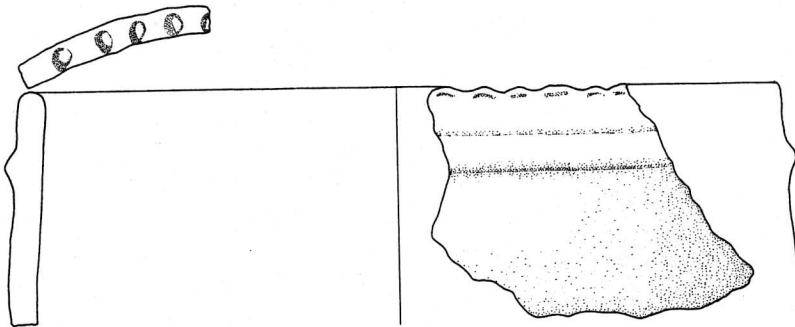

4

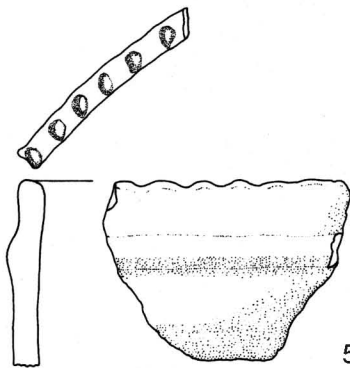

5

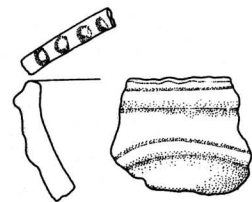

6

Tav. 8 - Santa Rosa di Poviglio: materiali ceramici provenienti dal pozzo US 2105; 1-6) da US 2141 (scala 1:3).

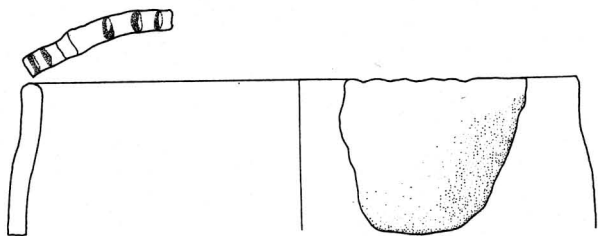

1

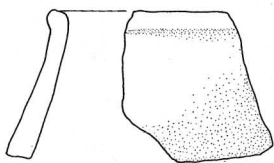

2

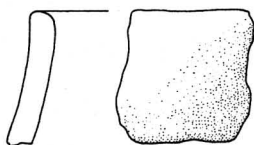

3

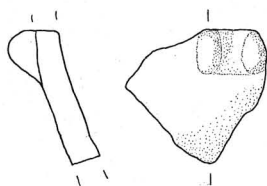

4

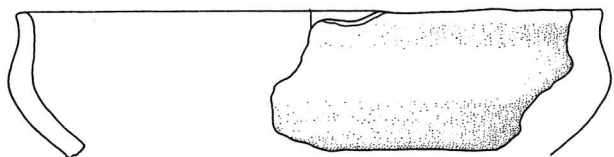

5

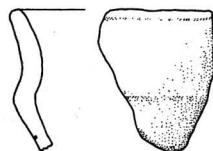

6

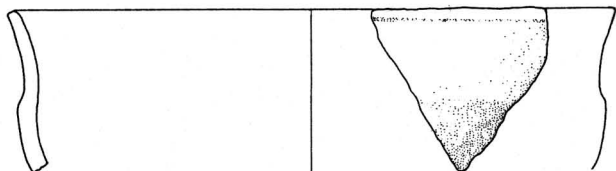

7

Tav. 9 - Santa Rosa di Poviglio: materiali ceramici provenienti dal pozzo US 2105; 1-4) da US 2141; 5-7) da US 2137 (scala 1:3).

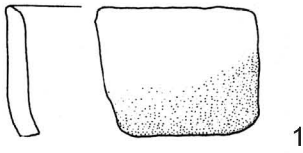

1

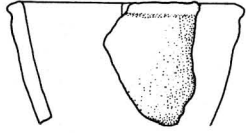

2

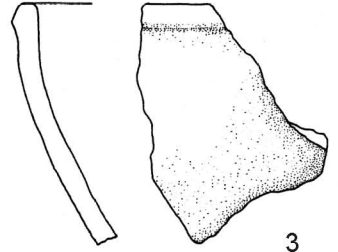

3

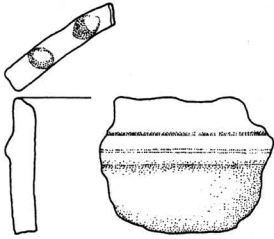

4

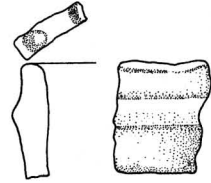

5

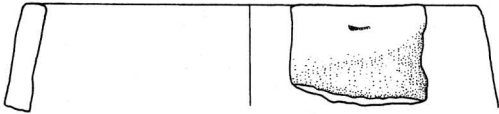

6

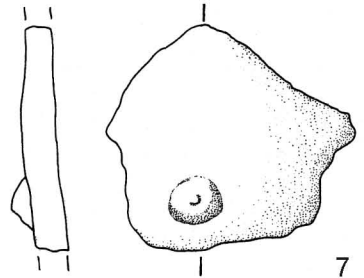

7

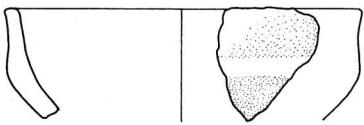

8

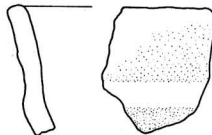

9

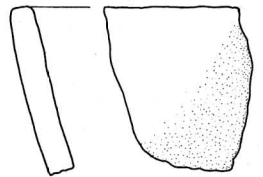

10

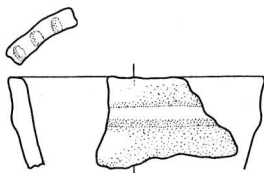

11

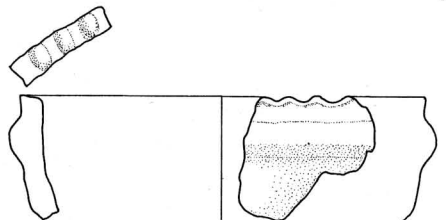

12

Tav. 10 - Santa Rosa di Poviglio: materiali ceramici provenienti dal pozzo US 2105; 1-7) da US 2137; 8-12) da US 2129 (scala 1:3).

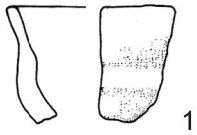

1

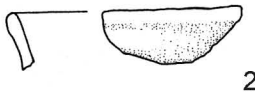

2

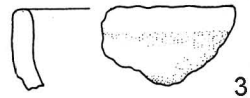

3

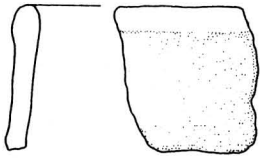

4

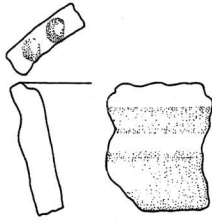

5

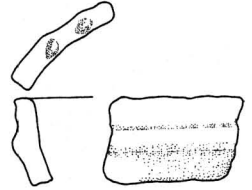

6

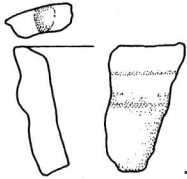

7

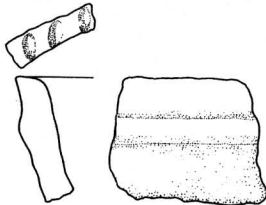

8

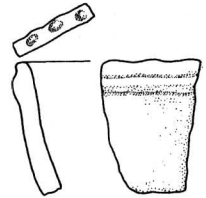

9

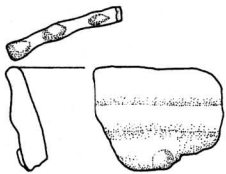

10

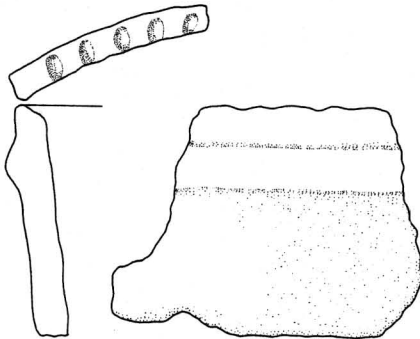

11

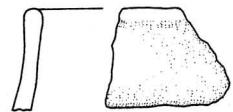

12



13

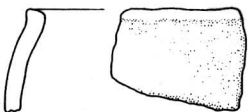

14

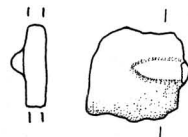

15

Tav. 11 - Santa Rosa di Poviglio: materiali ceramici provenienti dal pozzo US 2105; 1-15) da US 2108 (scala 1:3).

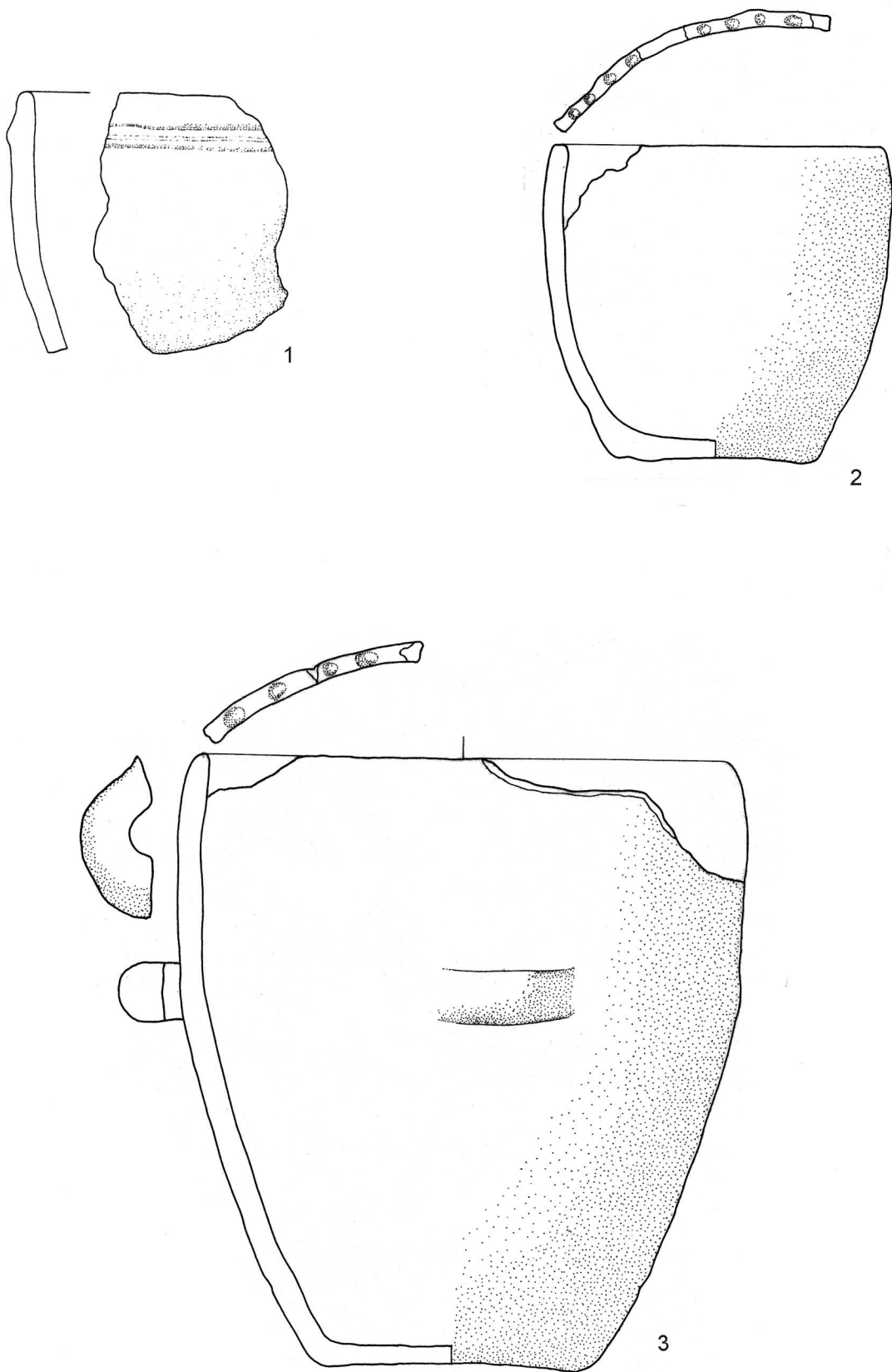

Tav. 12 - Santa Rosa di Poviglio: materiali ceramici provenienti dal pozzo US 2106; 1-3) da US 2244 (scala 1:3).

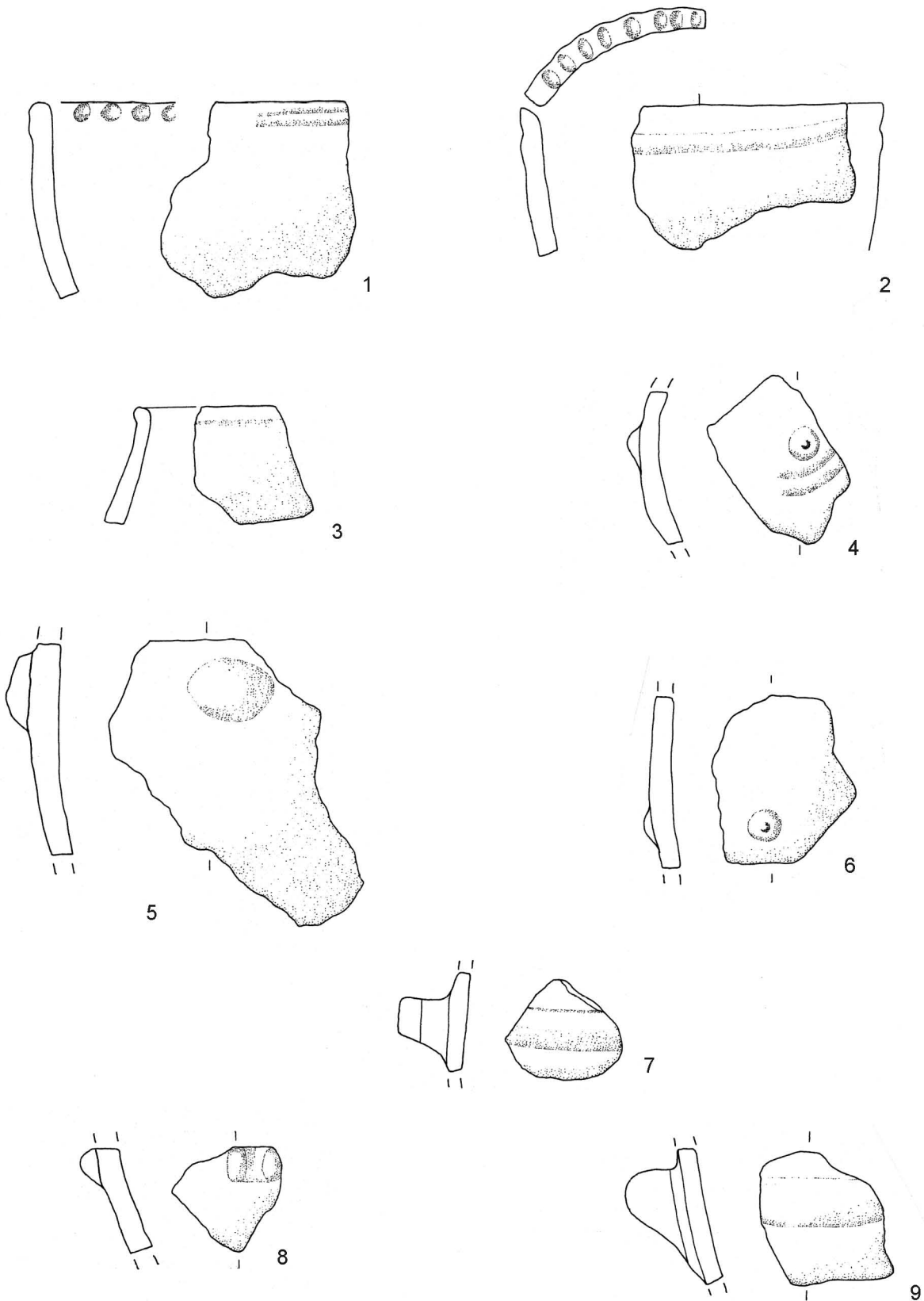

Tav. 13 - Santa Rosa di Poviglio: materiali ceramici provenienti dal pozzo US 2106; 1-9) da US 2244 (scala 1:3).

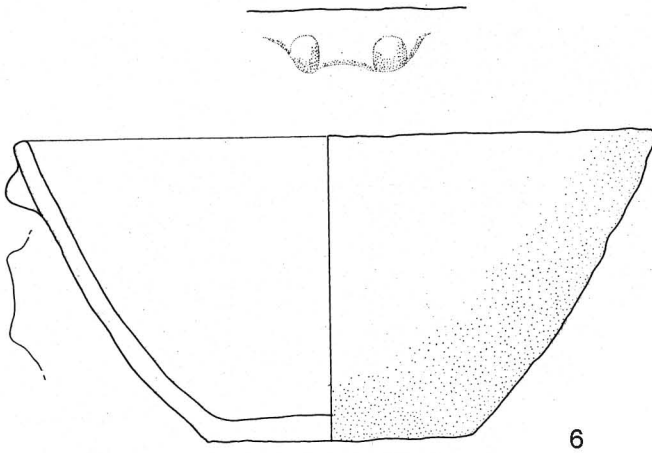
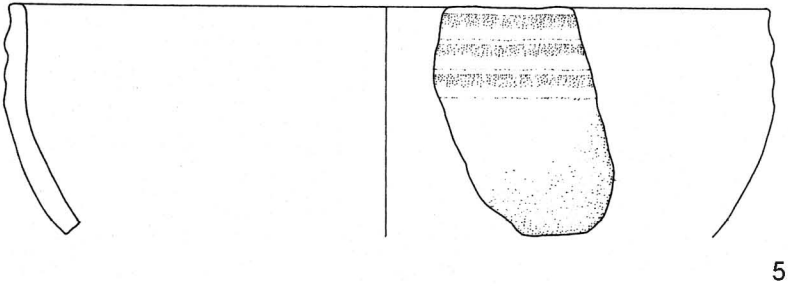
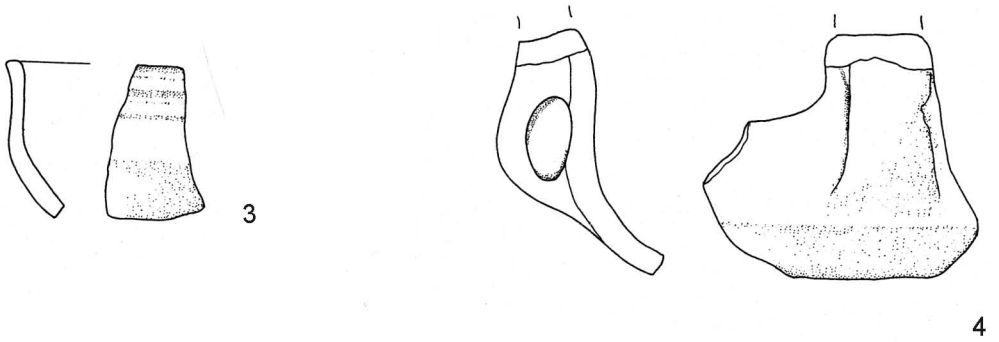
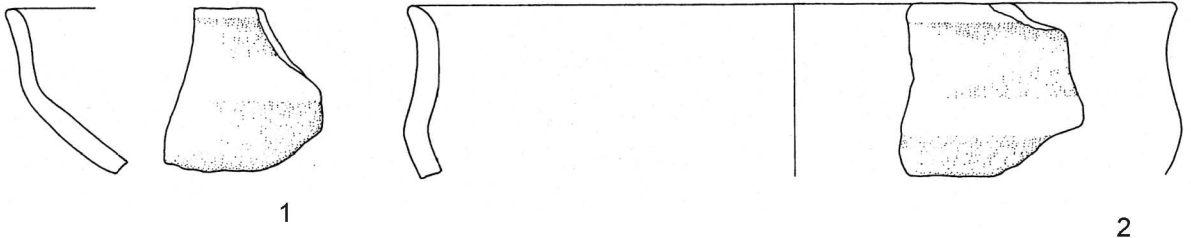

Tav. 14 - Santa Rosa di Poviglio: materiali ceramici provenienti dal pozzo US 2106; 1-6) da US 2228 (scala 1:3).

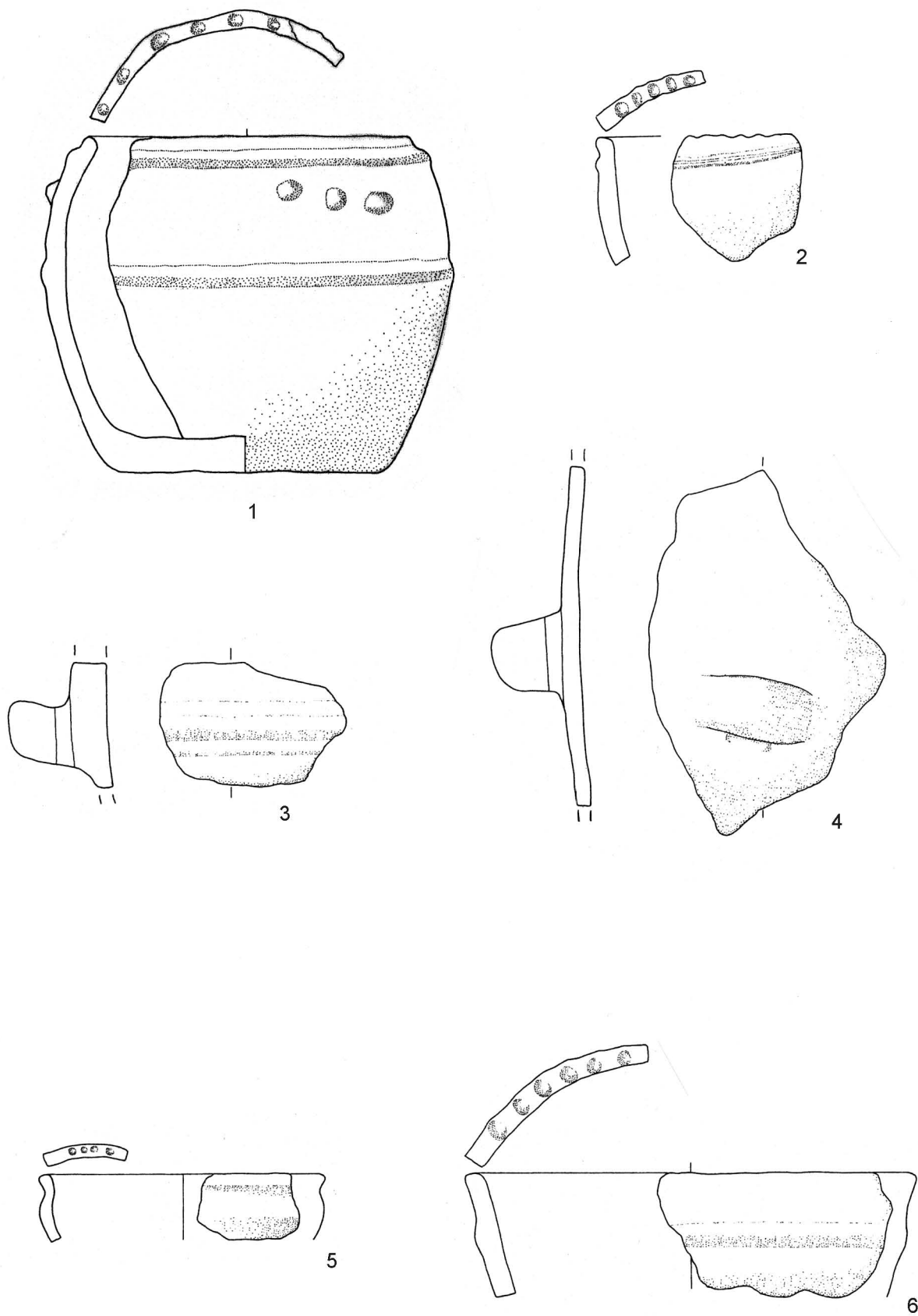

Tav. 15 - Santa Rosa di Poviglio: materiali ceramici provenienti dal pozzo US 2106; 1-4) da US 2228; 5-6) da US 2222 (scala 1:3).

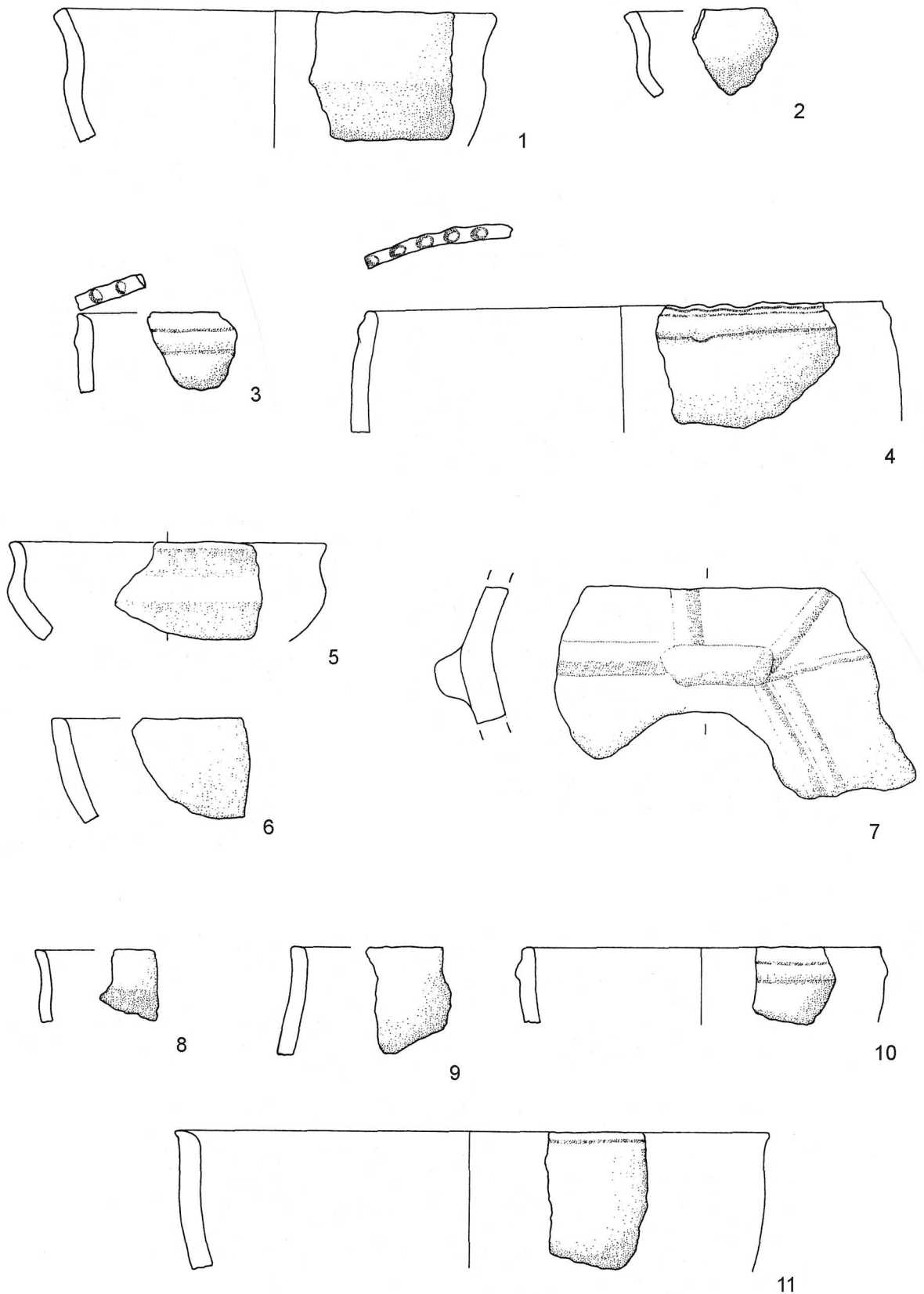

Tav. 16 - Santa Rosa di Poviglio: materiali ceramici provenienti dal pozzo US 2106; 1-4) da US 2164; 5-7) da US 2162; 9-11) da US 2147 (scala 1:3).

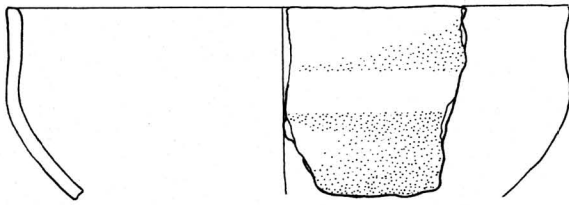

1

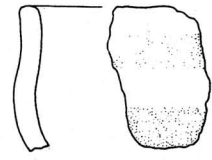

2

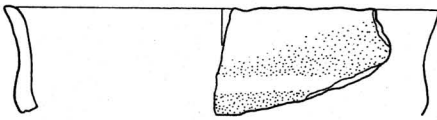

3

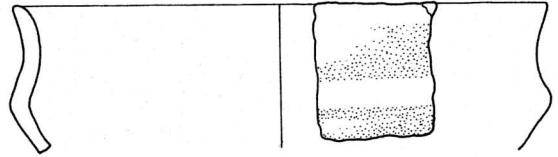

4

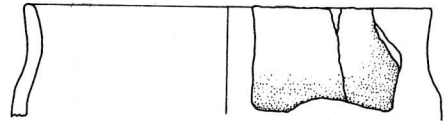

6

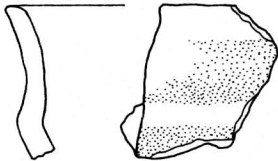

5

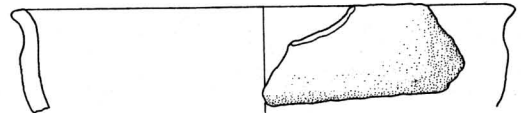

7

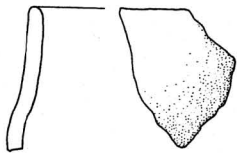

8

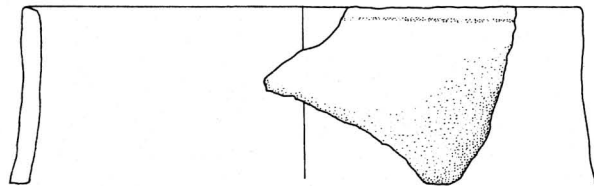

9

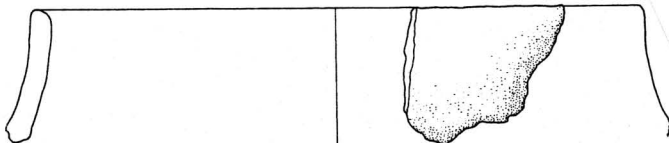

10

Tav. 17 - Santa Rosa di Poviglio: materiali ceramici provenienti dal pozzo US 2106; 1-10 da US 2144 (scala 1:3).

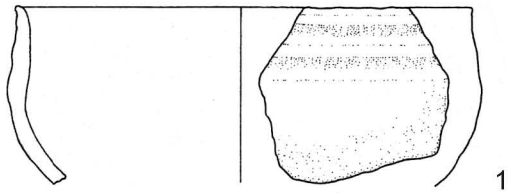

1

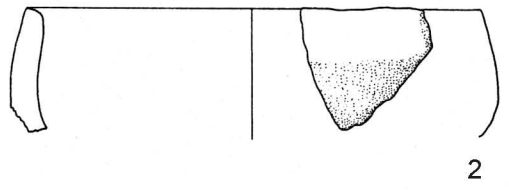

2

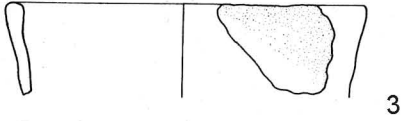

3

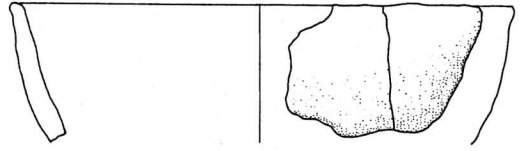

4

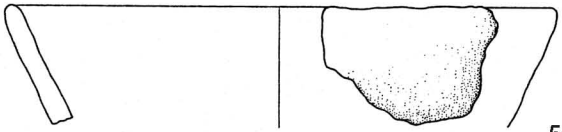

5

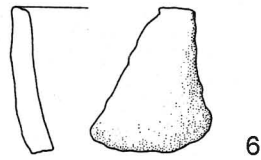

6

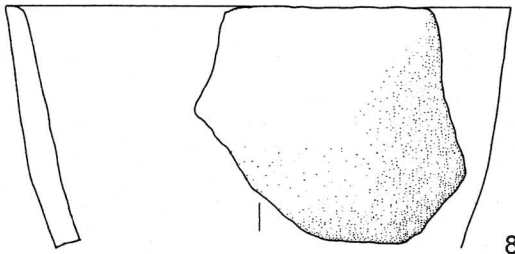

8

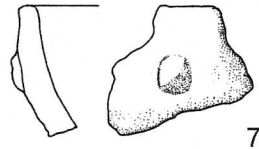

7

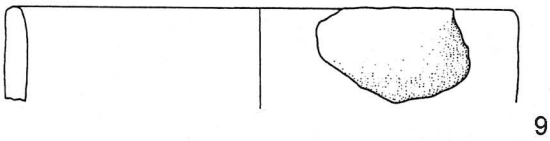

9

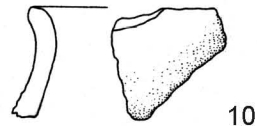

10

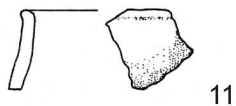

11

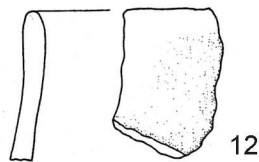

12

Tav. 18 - Santa Rosa di Poviglio: materiali ceramici provenienti dal pozzo US 2106; 1-12) da US 2144 (scala 1:3).

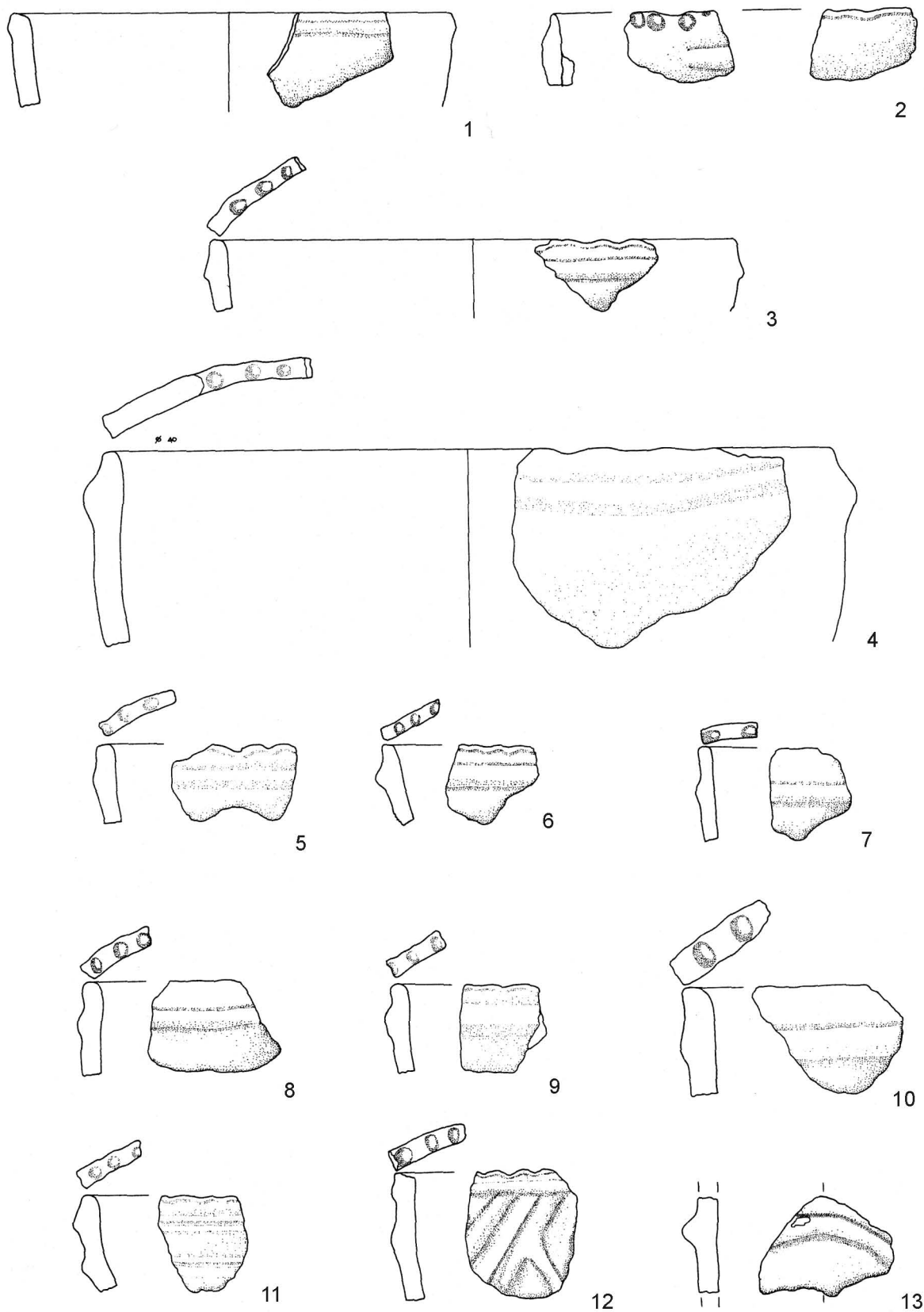

Tav. 19 - Santa Rosa di Poviglio: materiali ceramici provenienti dal pozzo US 2193; 1-13) da US 2144 (scala 1:3).

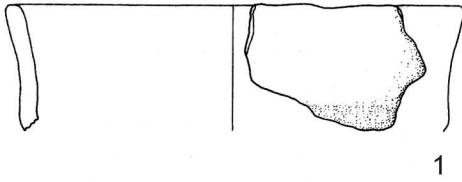

1

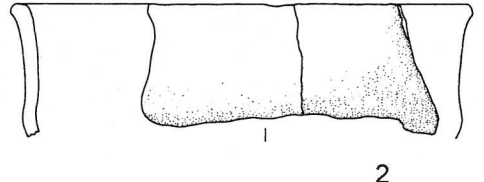

2

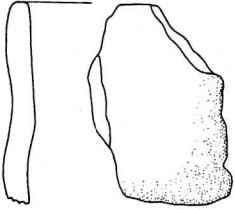

3

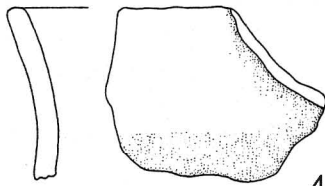

4

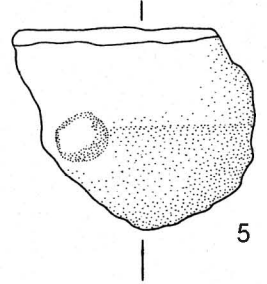

5

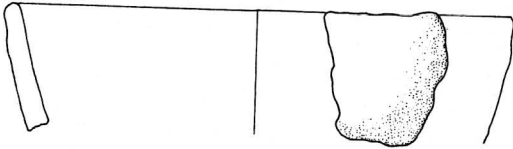

6

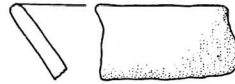

7

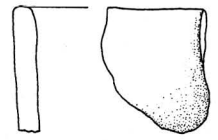

8

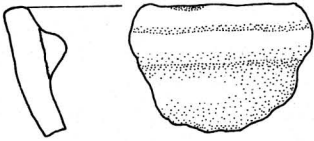
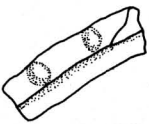

9

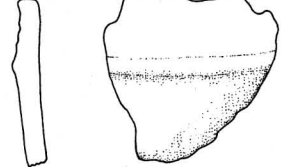
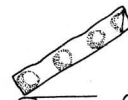
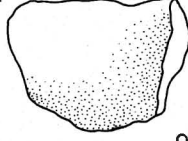

10

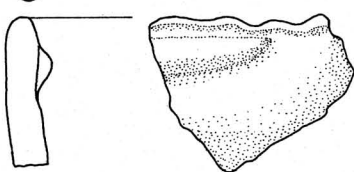
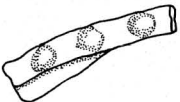

11

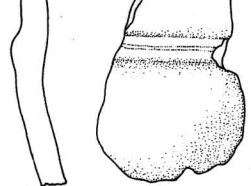
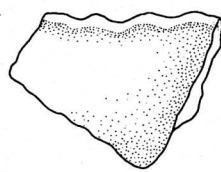

12

Tav. 20 - Santa Rosa di Poviglio: materiali ceramici provenienti dal pozzo US 2106; 1-12) da US 2142 (scala 1:3).

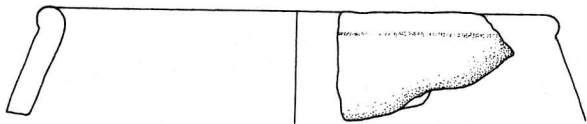

1

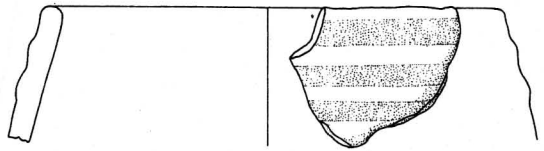

2

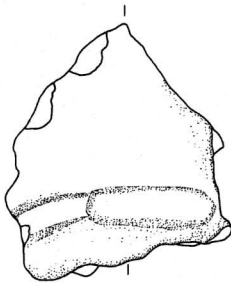

3

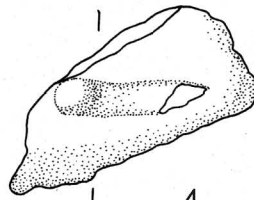

4

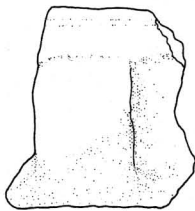
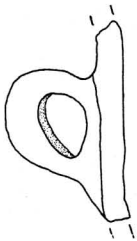

5

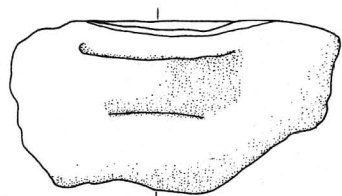
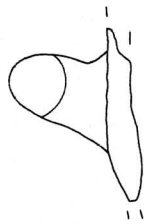

6

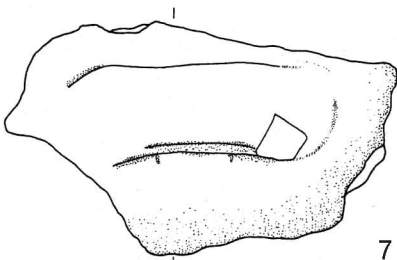
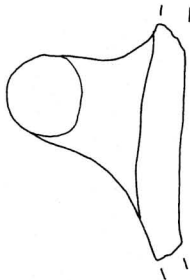

7

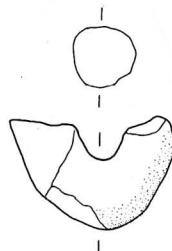

8

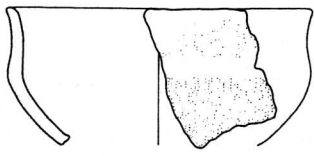

1



2

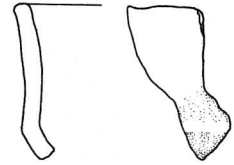

3

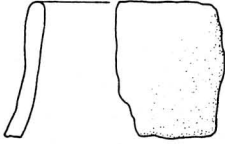

4

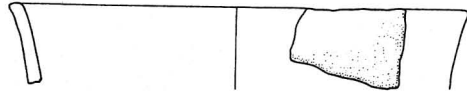

5

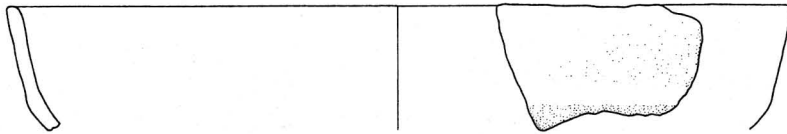

6

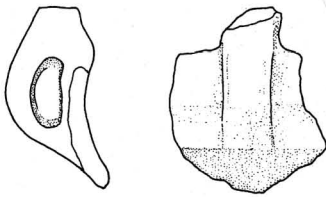

7

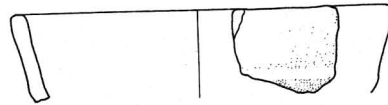

8

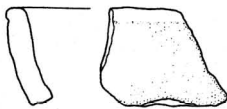

9

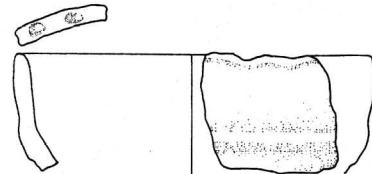

10

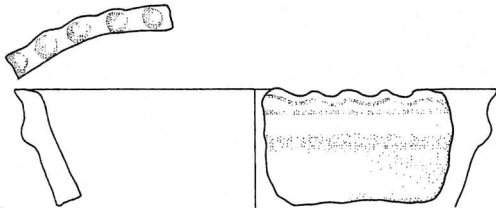

11

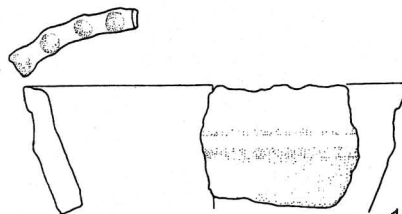

12

Tav. 22 - Santa Rosa di Poviglio: materiali ceramici del pozzo US 2106; 1-12) da US 2129 (scala 1:3).

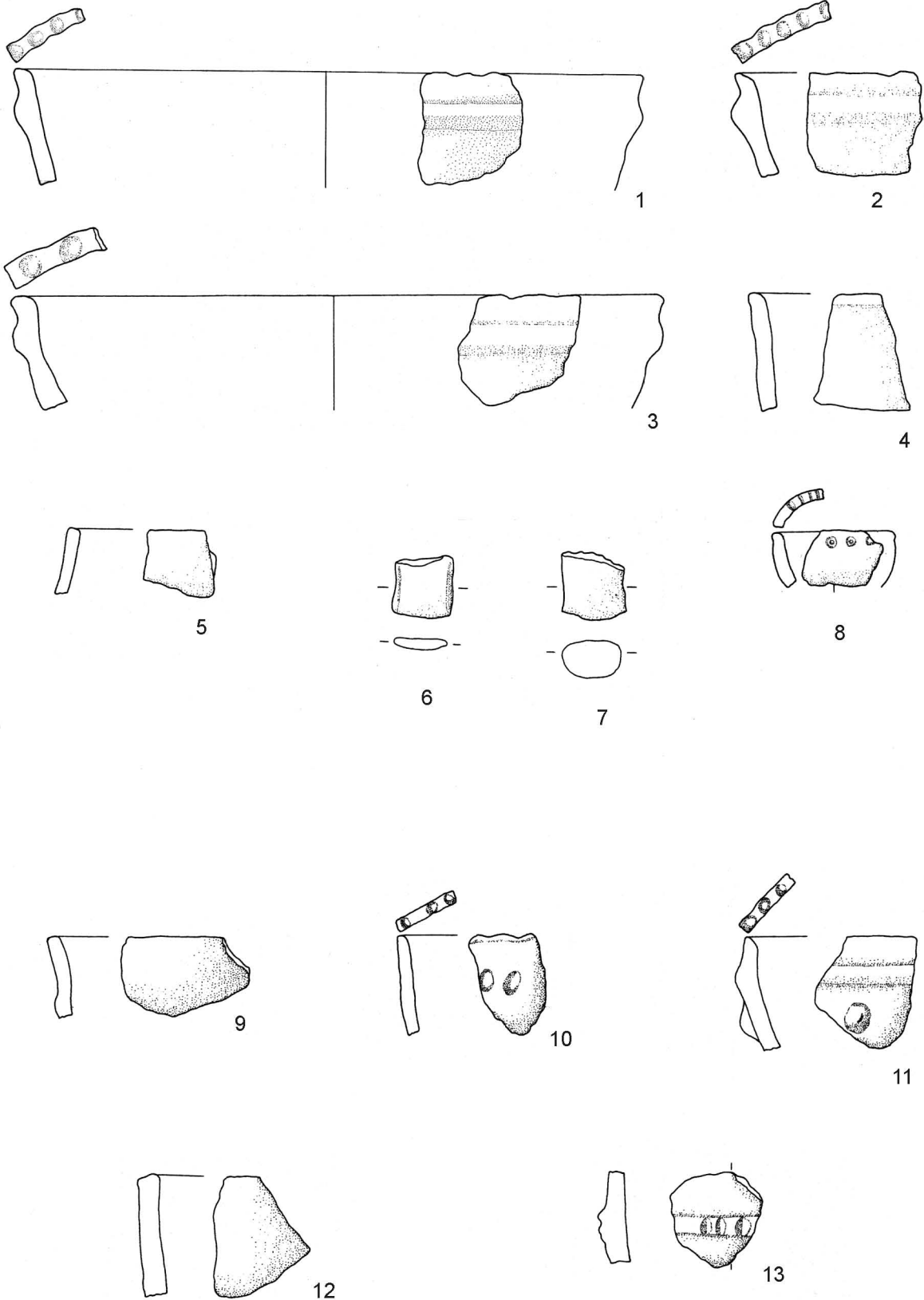

Tav. 23 - Santa Rosa di Poviglio: materiali ceramici provenienti dal pozzo US 2106; 1-8) da US 2129; 9-13) da US 2127 (scala 1:3).

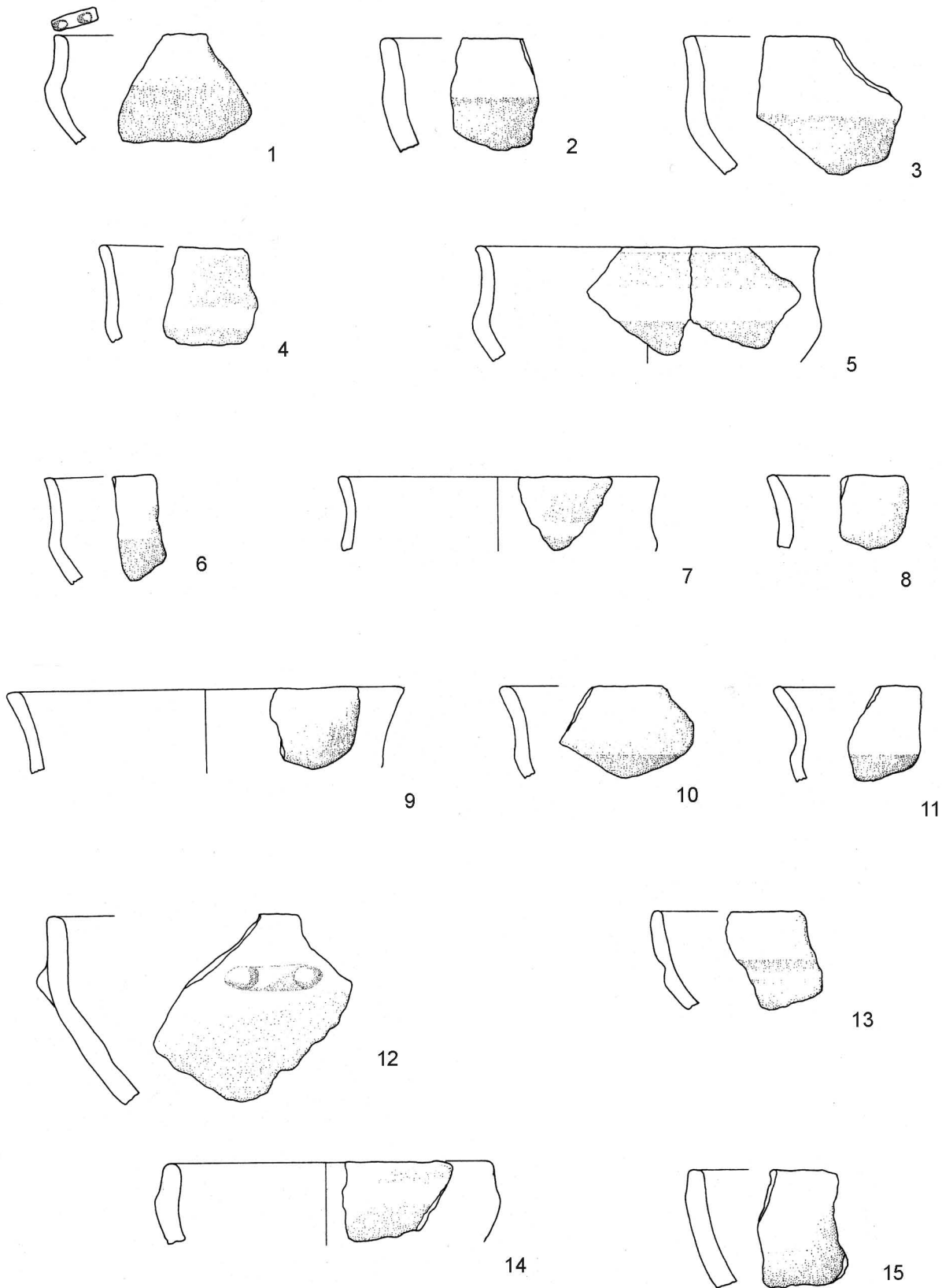

Tav. 24 - Santa Rosa di Poviglio: materiali ceramici provenienti dal pozzo US 2106; 1-15) da US 2114 (scala 1:3).

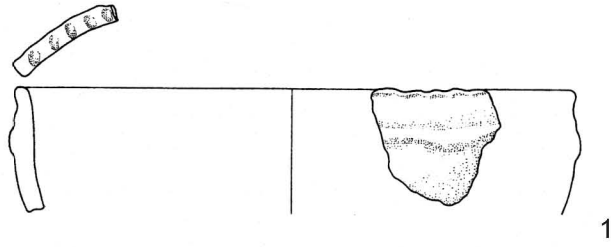

1

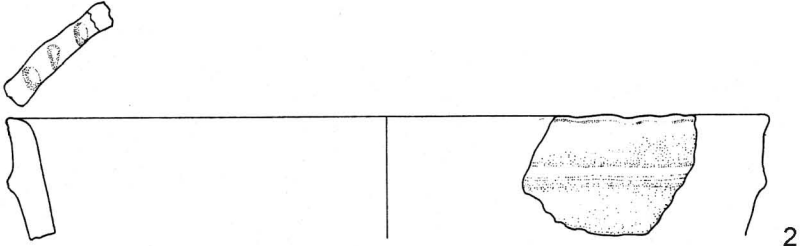

2

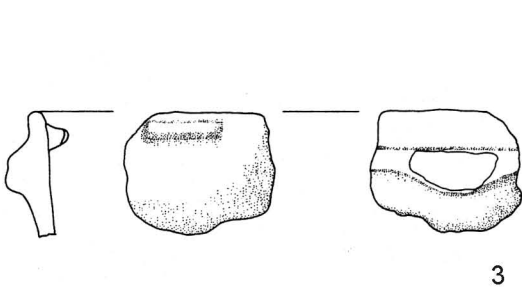

3

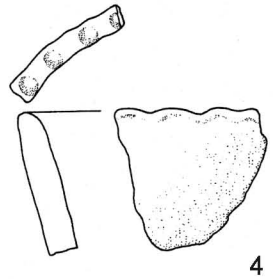

4

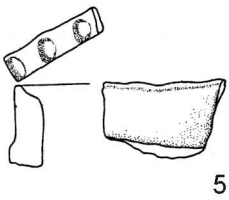

5

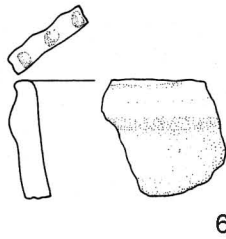

6

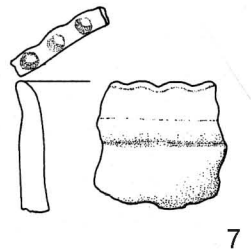

7

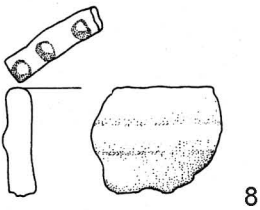

8

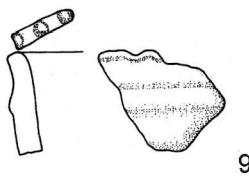

9

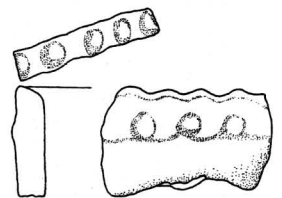

10

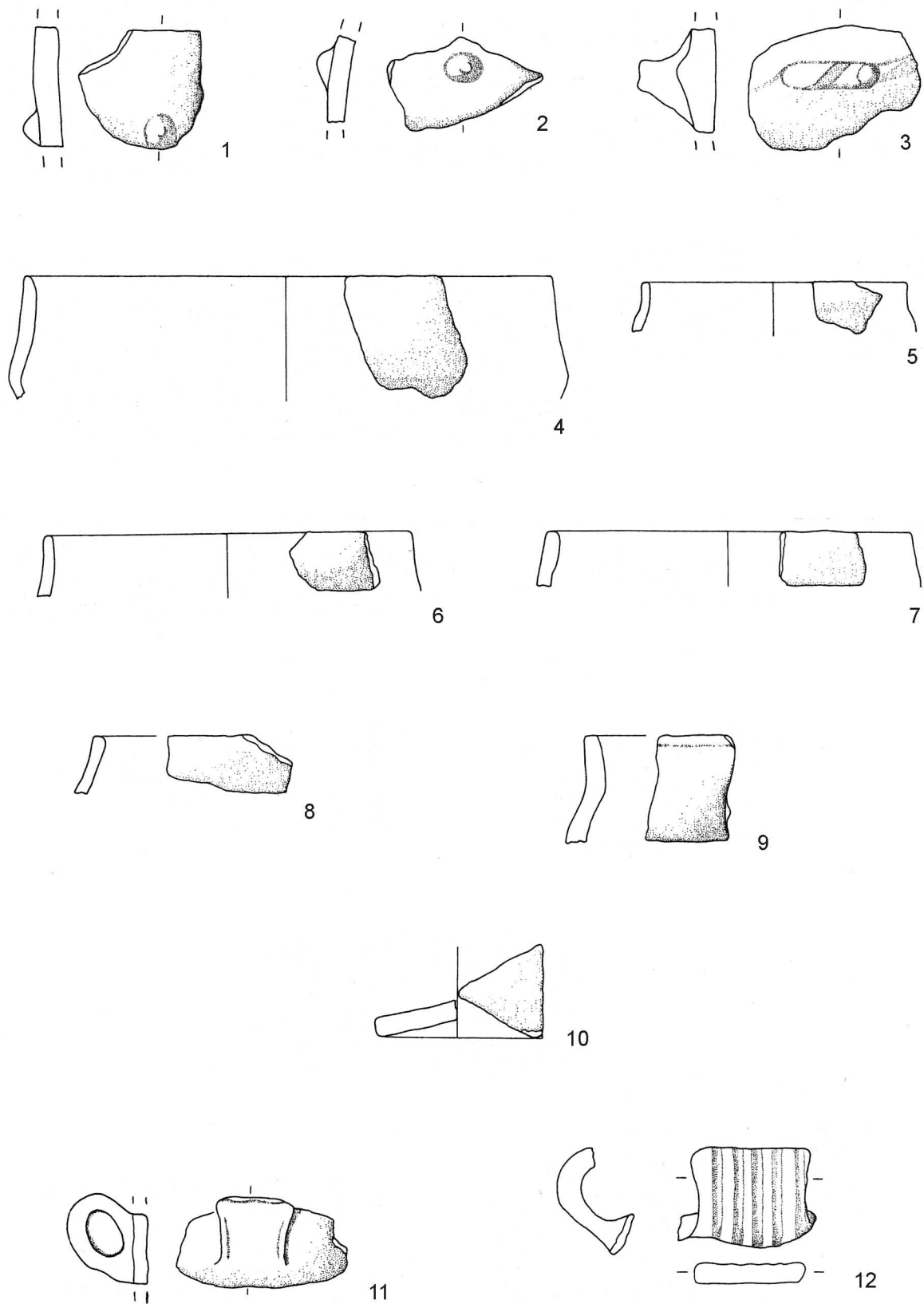

Tav. 26 - Santa Rosa di Poviglio: materiali ceramici provenienti dal pozzo US 2106; 1-12) da US 2114 (scala 1:3).

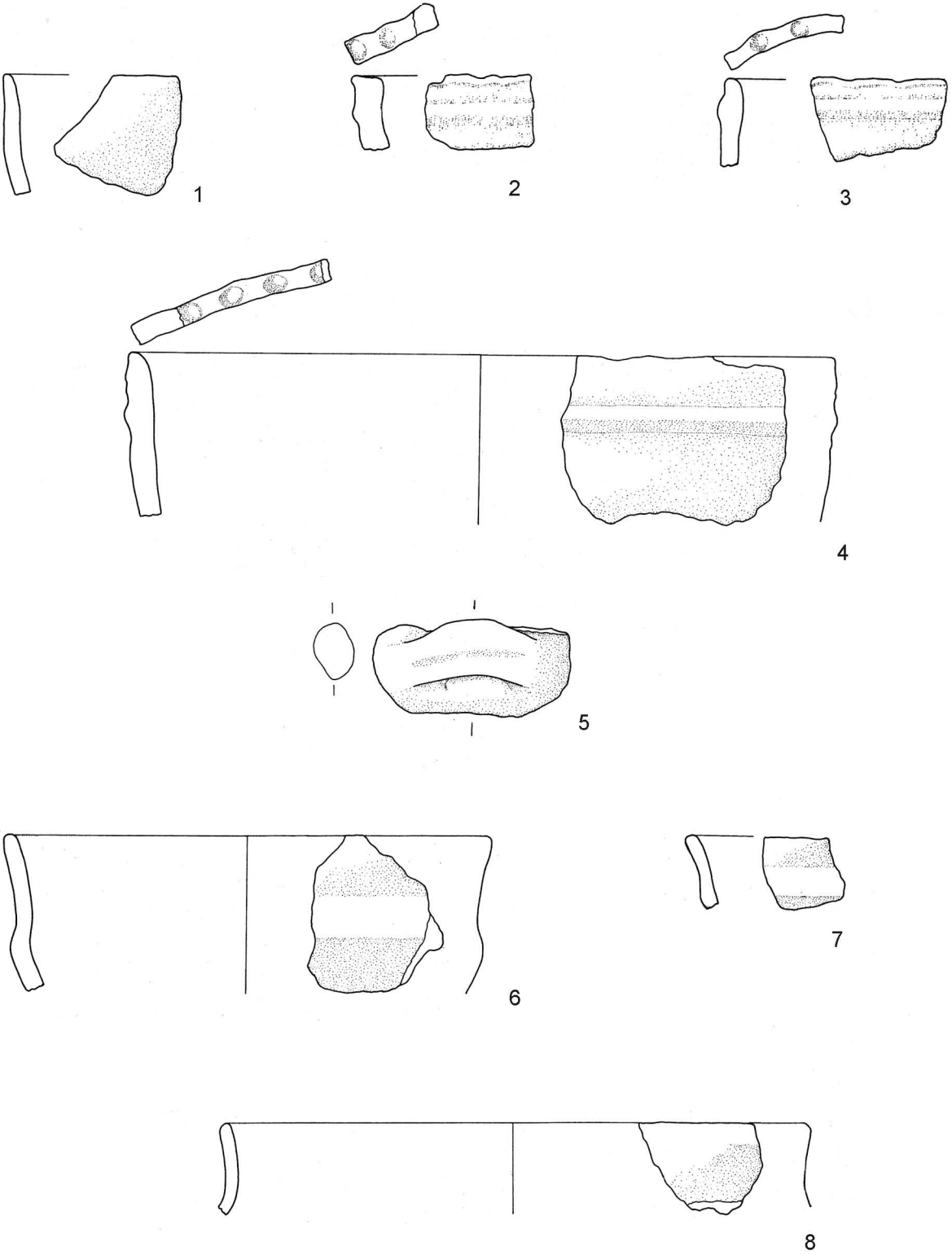

Tav. 27 - Santa Rosa di Poviglio: materiali ceramici provenienti dal pozzo US 1860; 1-5) da US 1906; 6-8) da US 1859a (scala 1:3).

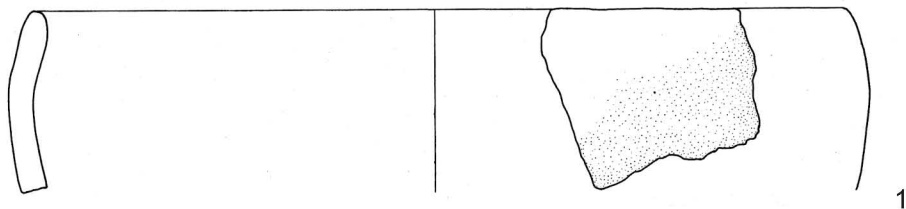

1

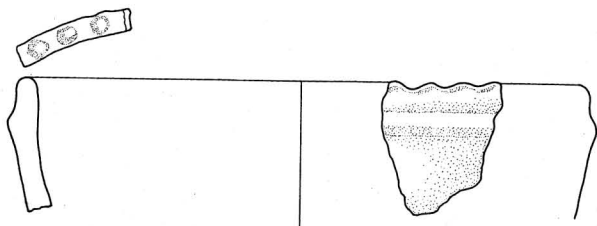

2

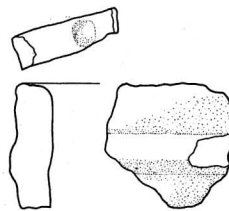

3

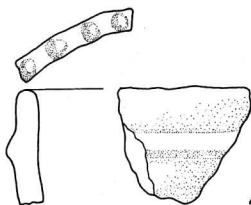

4

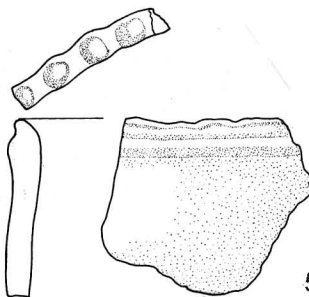

5

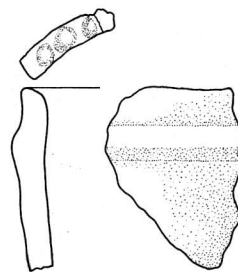

6

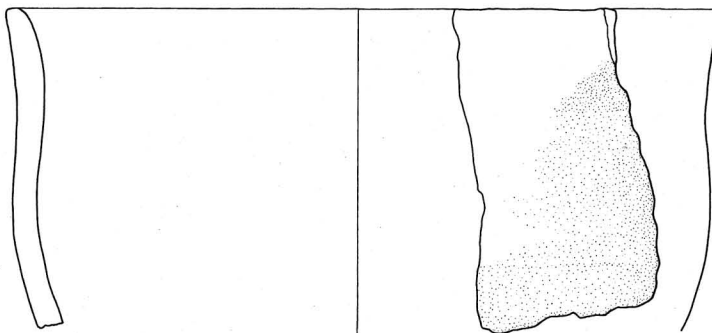

7

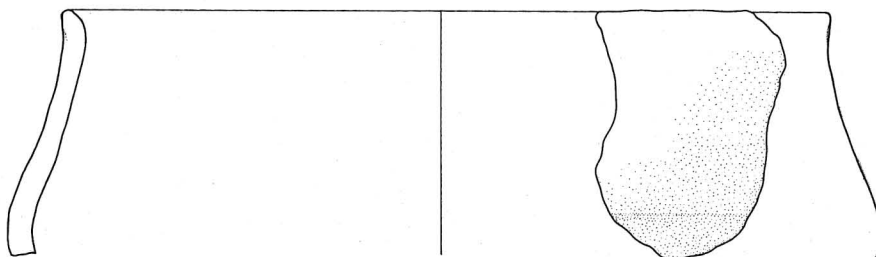

8

Tav. 28 - Santa Rosa di Poviglio: materiali ceramici provenienti dal pozzo US 1860; 1-8) da US 1859a (scala 1:3).

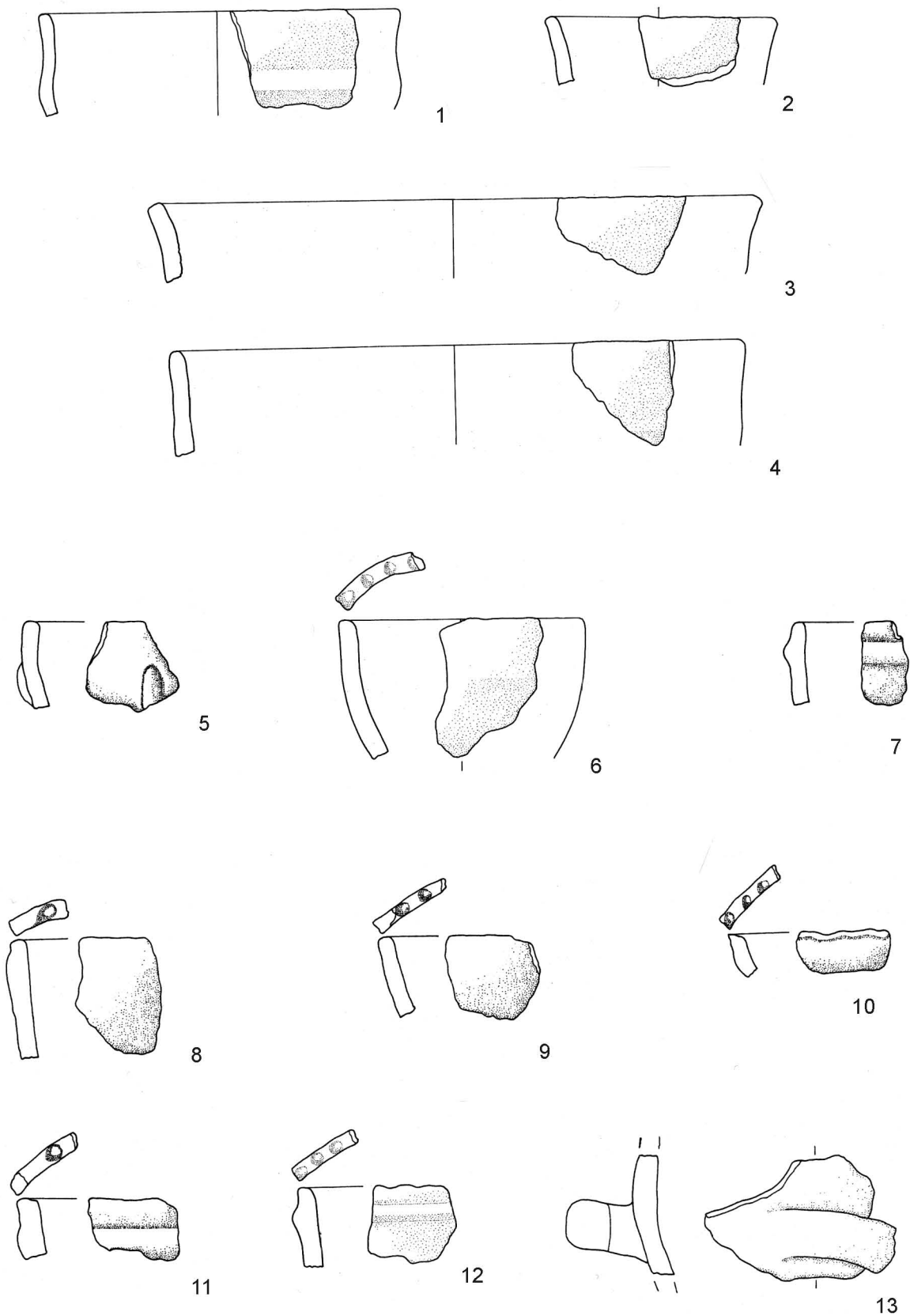

Tav. 29 - Santa Rosa di Poviglio: materiali ceramici provenienti dal pozzo US 1860; 1-13) da US 1859 (scala 1:3).

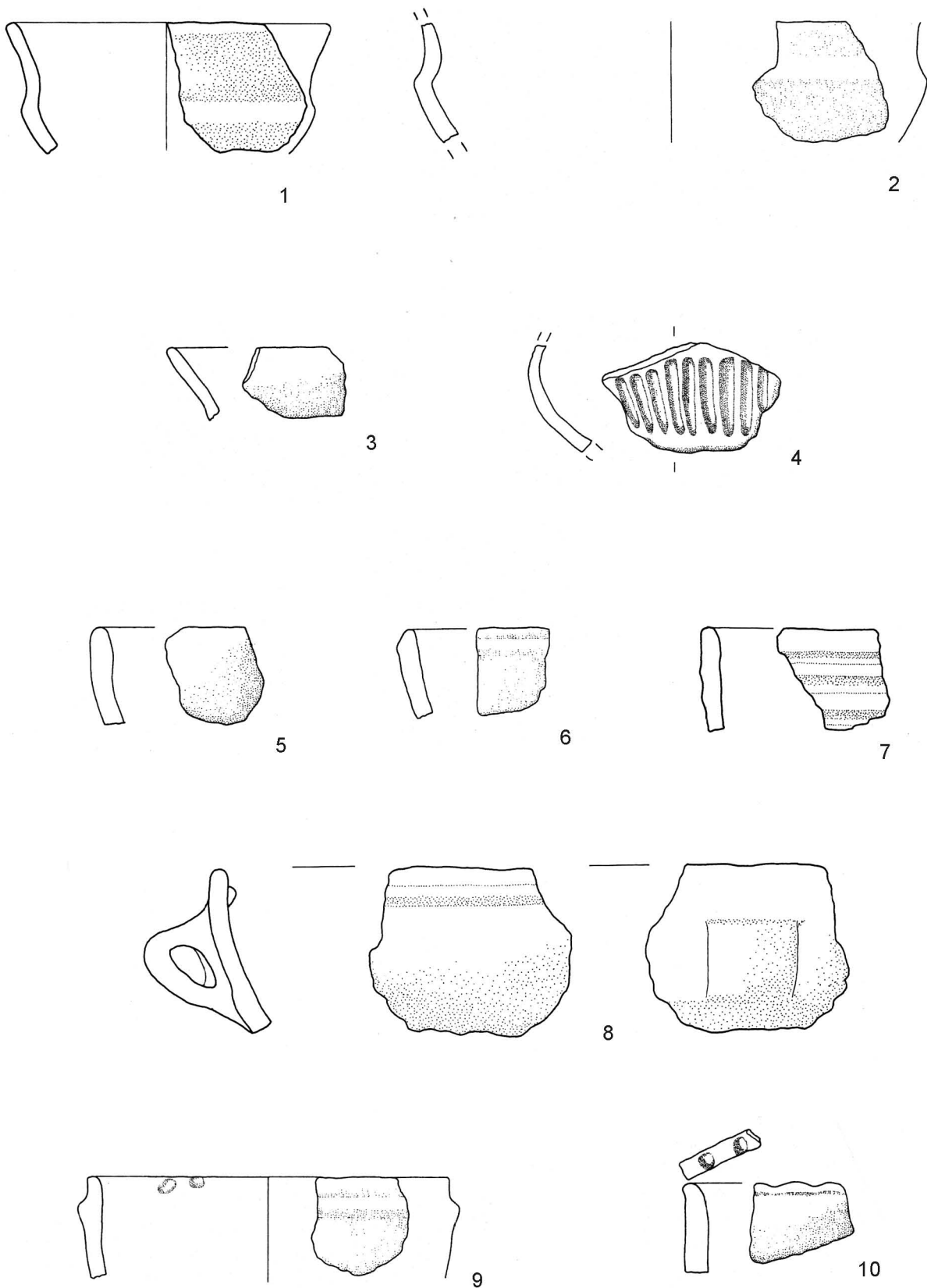

Tav. 30 - Santa Rosa di Poviglio: materiali ceramici provenienti dal pozzo US 1885; 1-10) da US 1889 (scala 1:3).

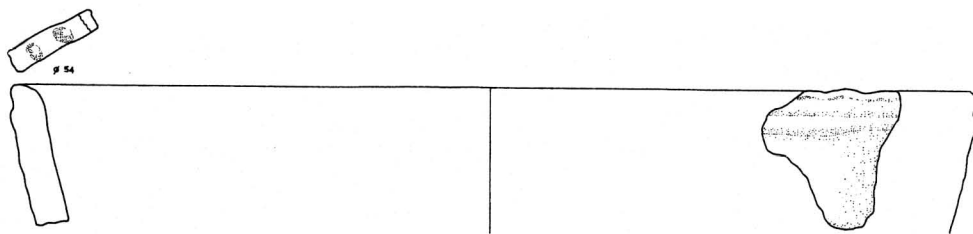

1

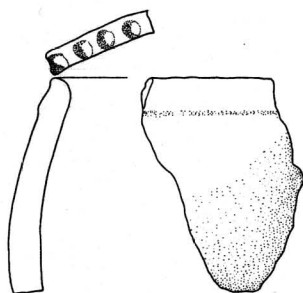

2

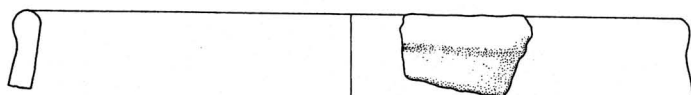

3

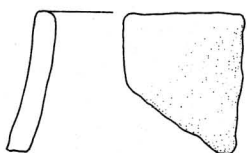

4



5

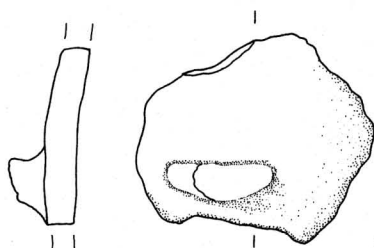

6

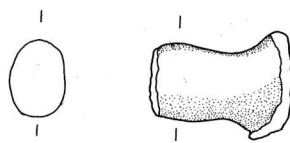

7

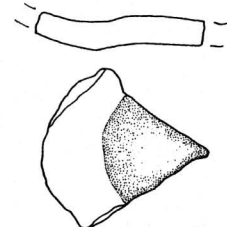

8

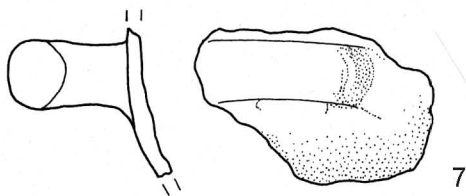
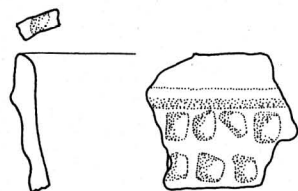
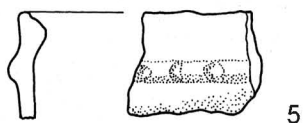
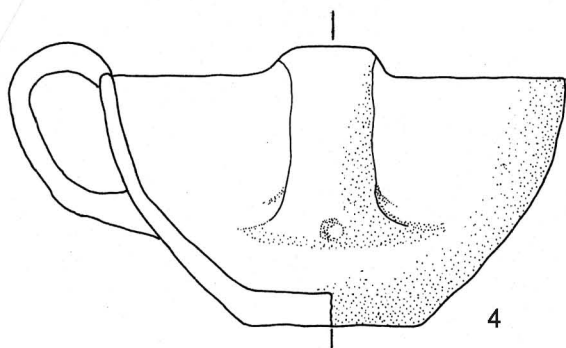
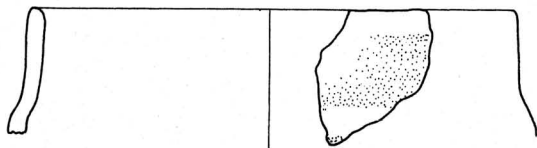
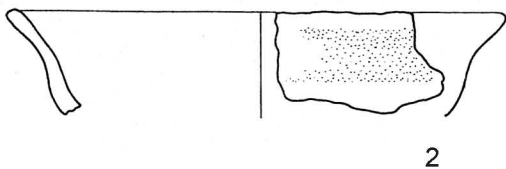
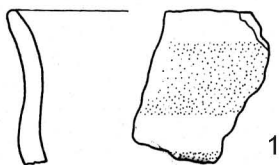

Tav. 32 - Santa Rosa di Poviglio: materiali ceramici provenienti dal pozzo US 1333; 1-7) da US 1137 (scala 1:3).

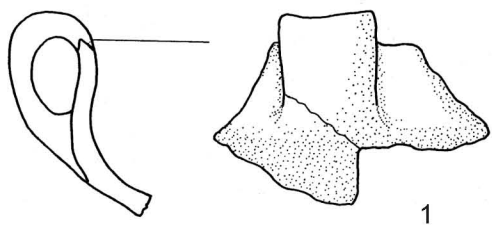

1

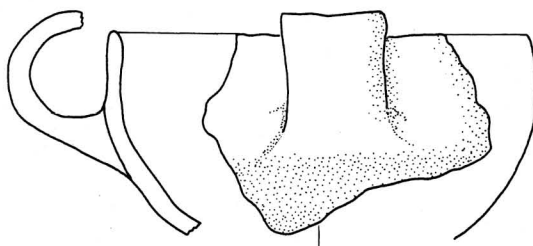

2

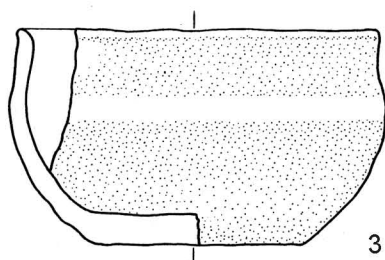

3

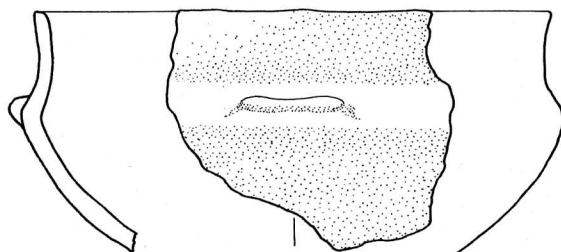

4

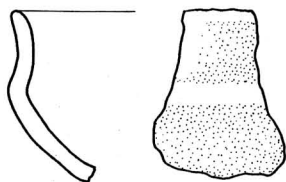

5

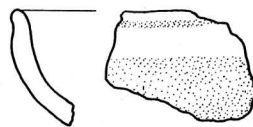

6

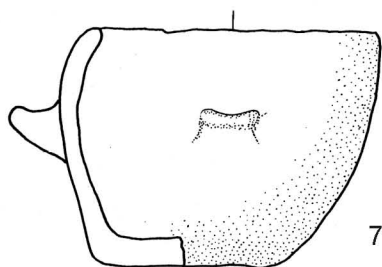

7

Tav. 33 - Santa Rosa di Poviglio: materiali ceramici provenienti dal pozzo US 1336; 1-7) da US 1764 (scala 1:3).

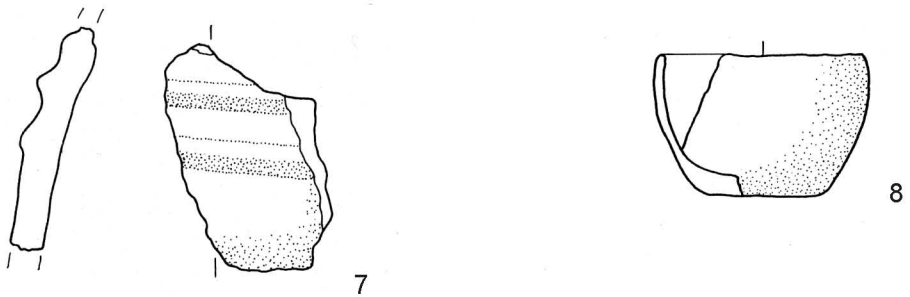
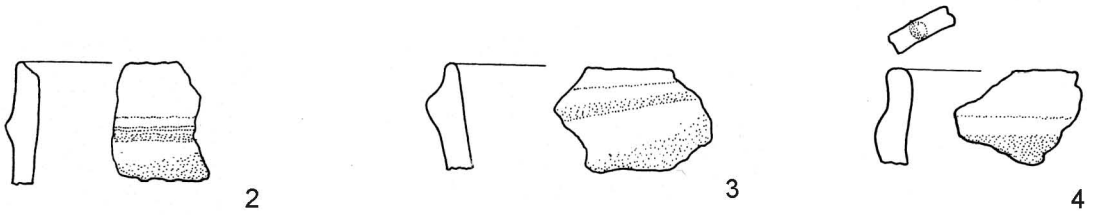
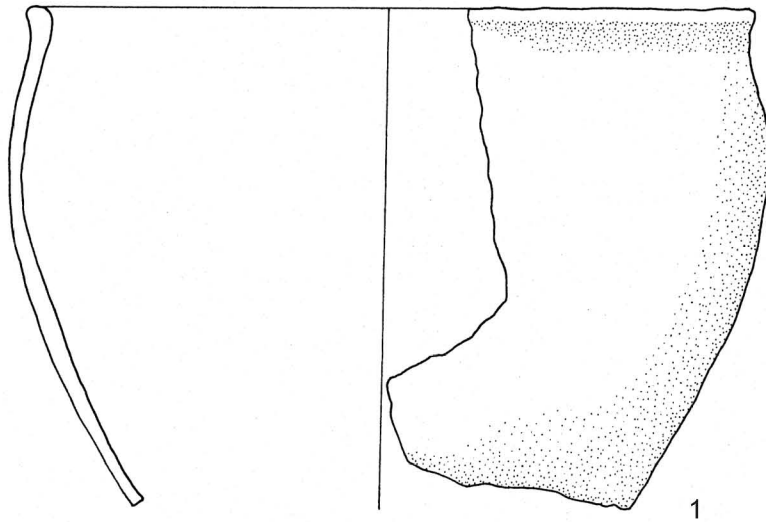

Tav. 34 - Santa Rosa di Poviglio: materiali ceramici provenienti dal pozzo US 1336; 1) da US 1764; 2-8) da US 1168 (scala 1:3).

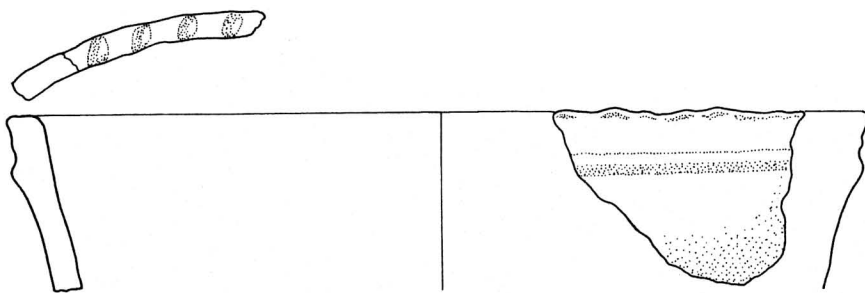

1

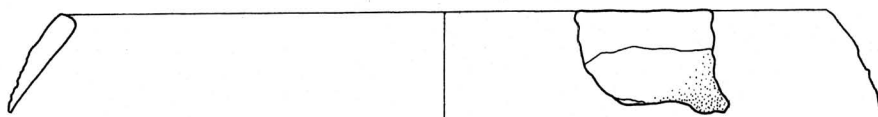

2

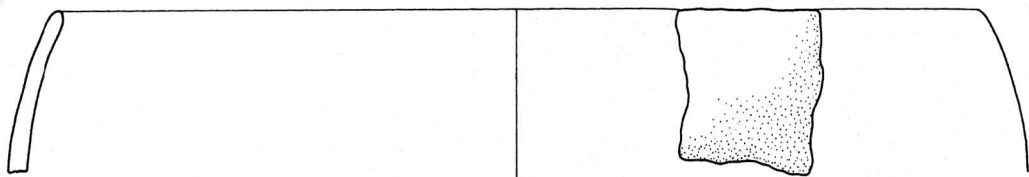

3

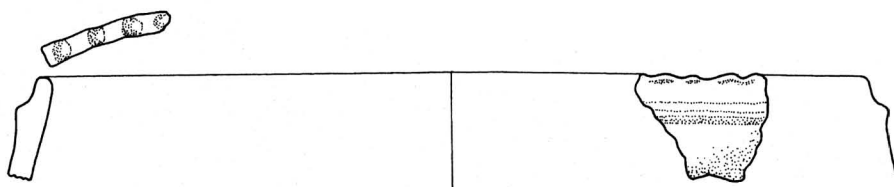

4

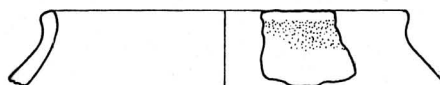

5

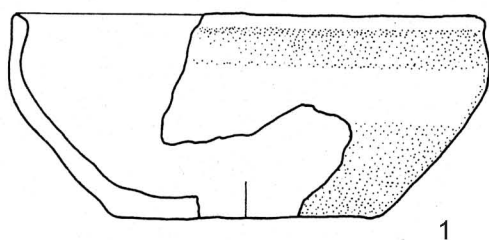

1

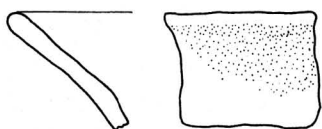

2

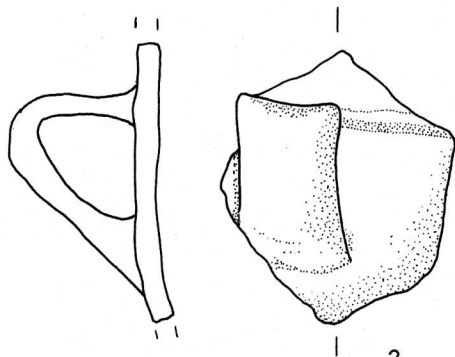

3

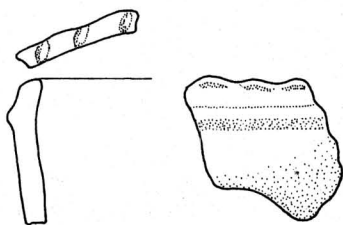

4

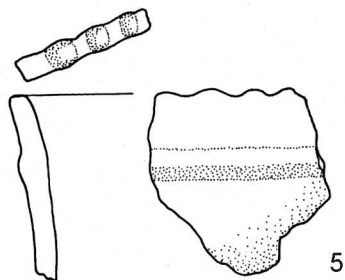
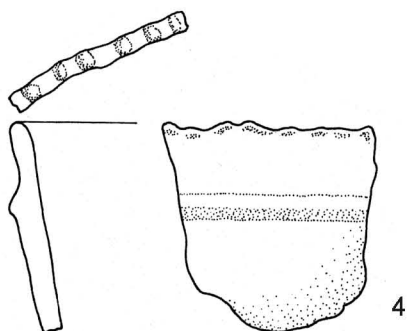
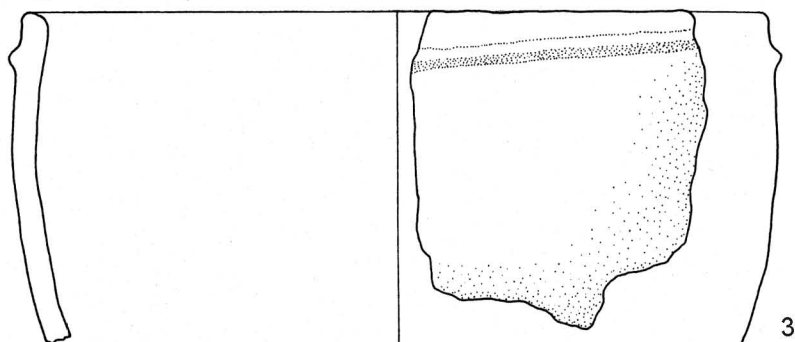
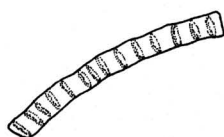
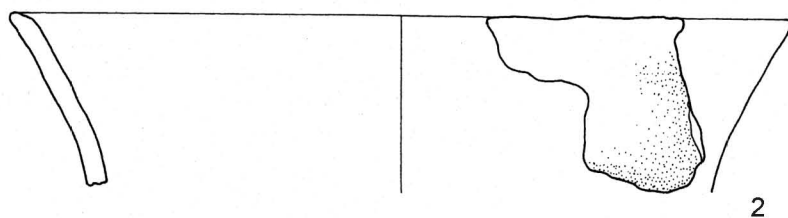
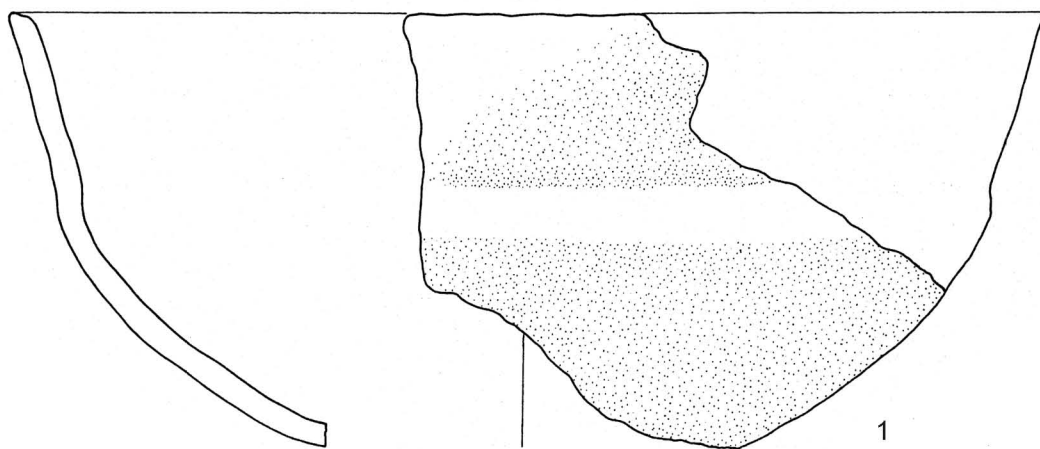

Tav. 37 - Santa Rosa di Poviglio: materiali ceramici provenienti dal pozzo US 1548; 1-5) da US 1603 (scala 1:3).

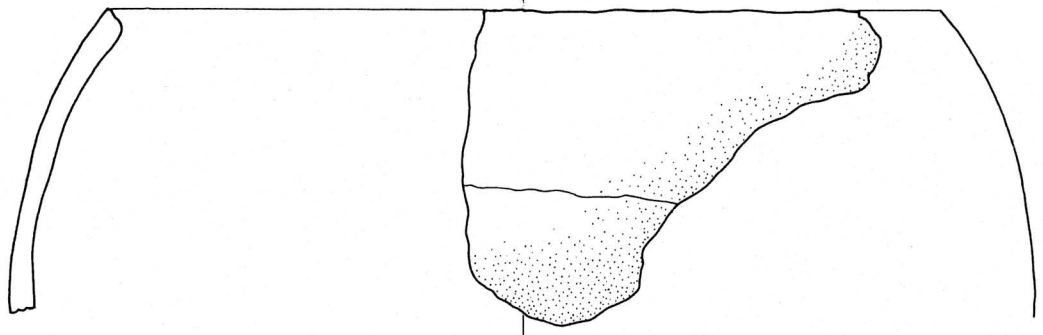

1

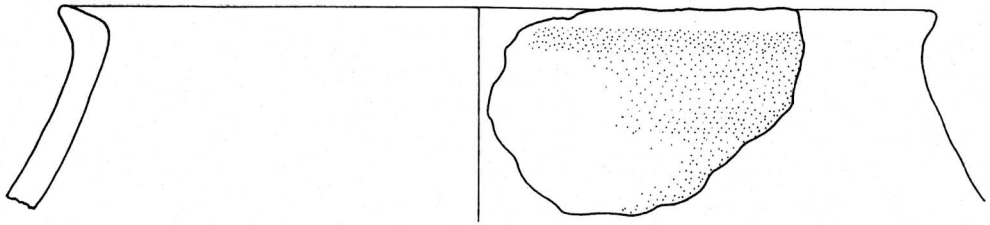

2

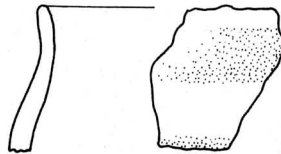

3

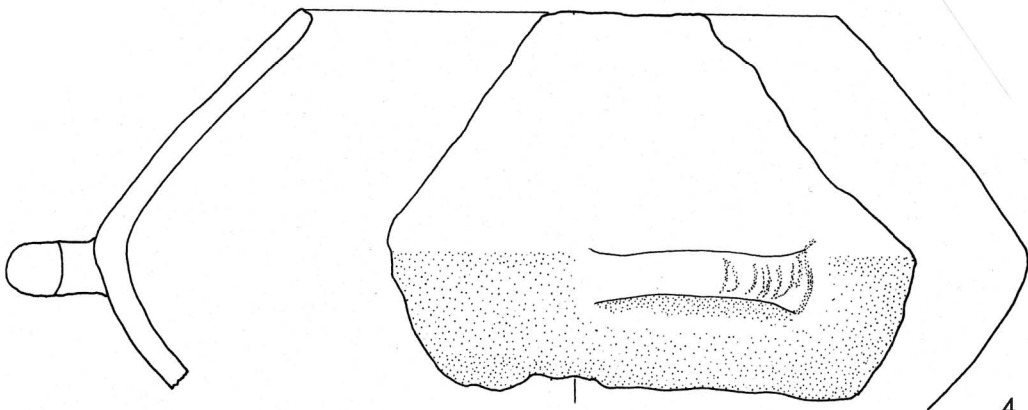

4

Tav. 38 - Santa Rosa di Poviglio: materiali ceramici provenienti dal pozzo US 1548; 1-4) da US 1603 (scala 1:3).

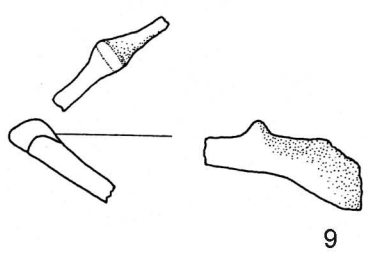
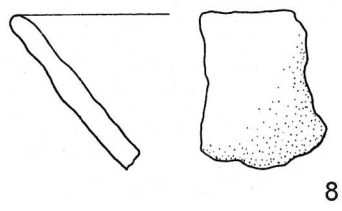
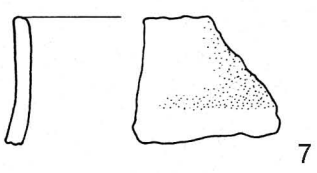
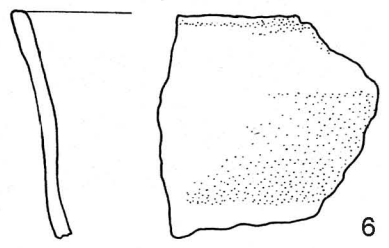
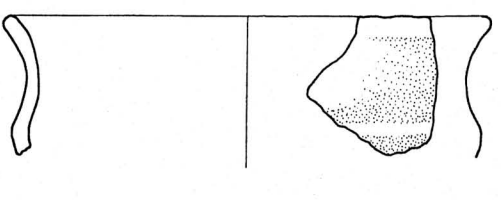
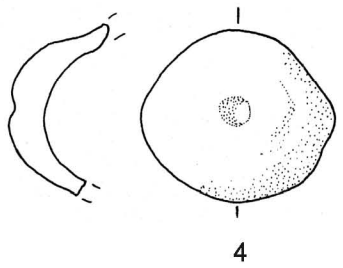
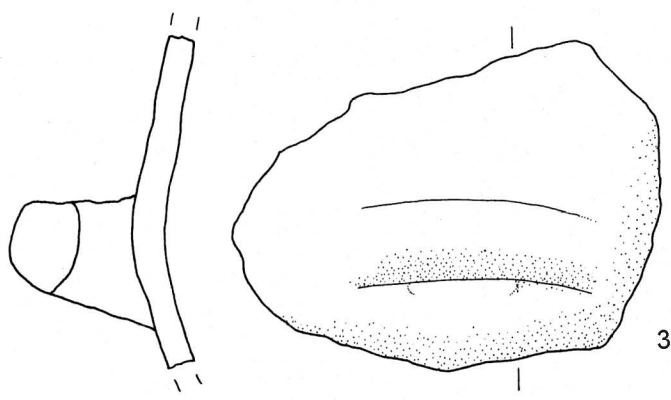
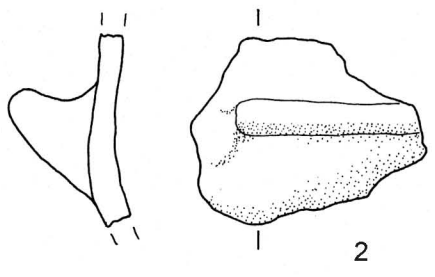
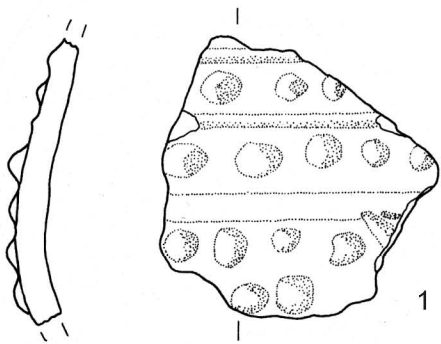

Tav. 39 - Santa Rosa di Poviglio: materiali ceramici provenienti dal pozzo US 1548; 1-4 da US 1603; 5-9 da US 1602 (scala 1:3).

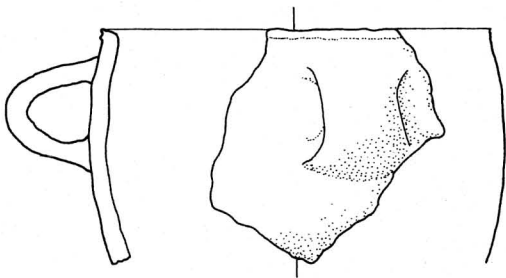

1

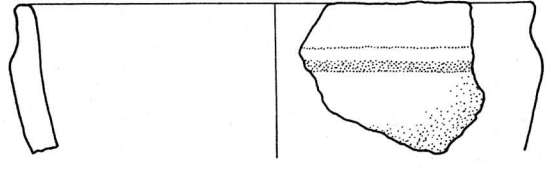

2

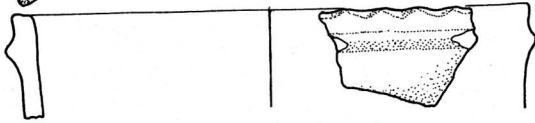
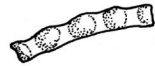

3

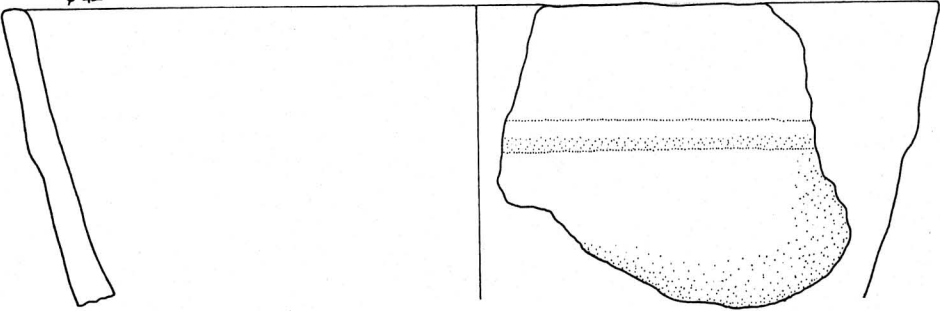
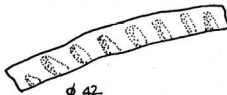

4

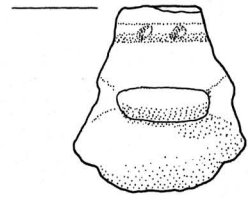
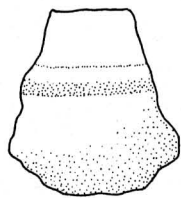

5

Tav. 40 - Santa Rosa di Poviglio: materiali ceramici provenienti dal pozzo US 1548; 1-5 da US 1602 (scala 1:3).

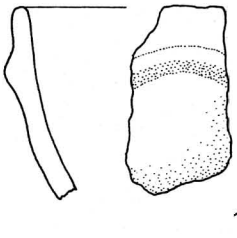

1

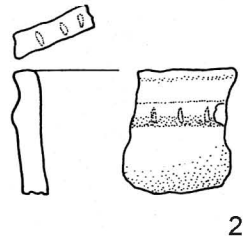

2

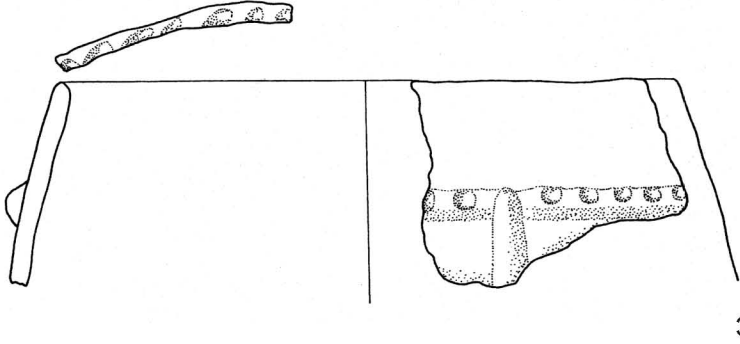

3

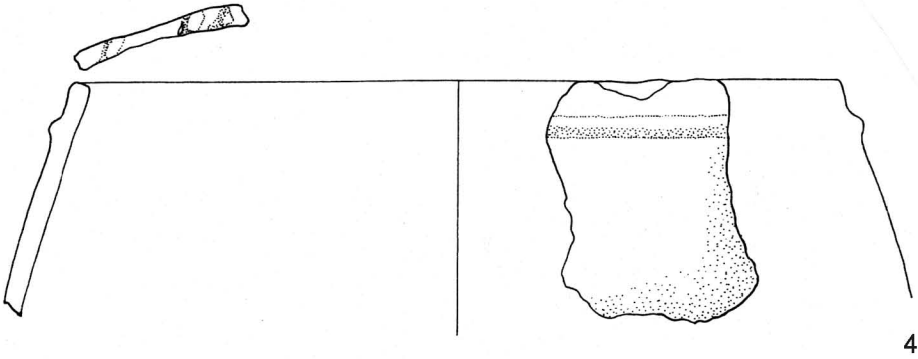

4

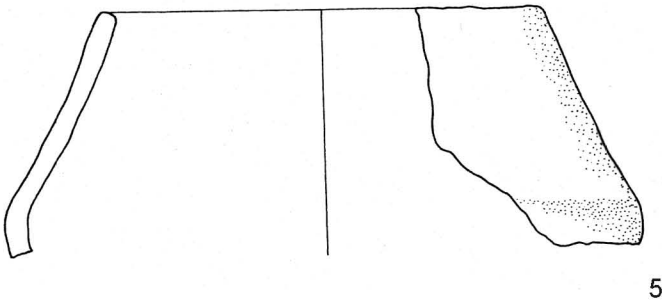

5

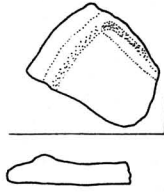

1

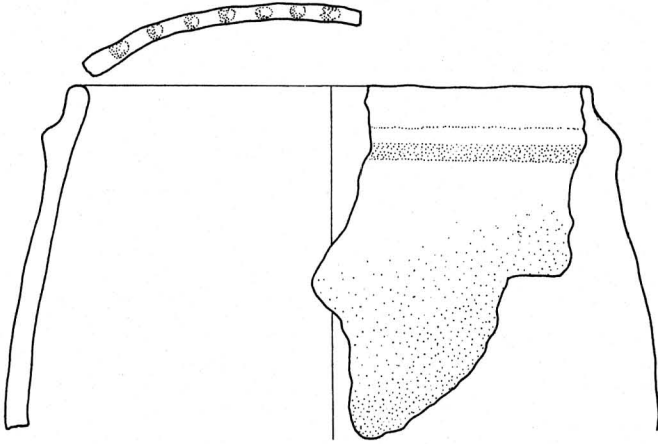

2

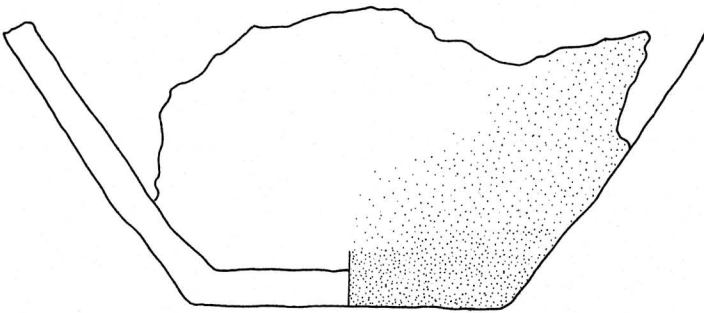

3

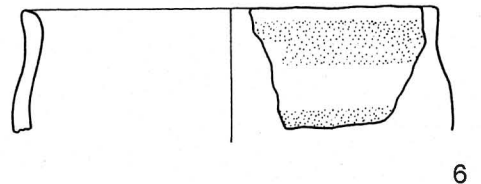
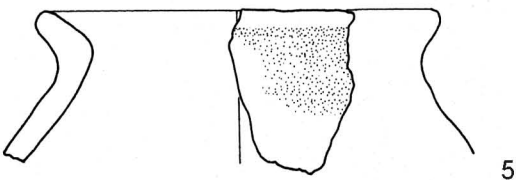
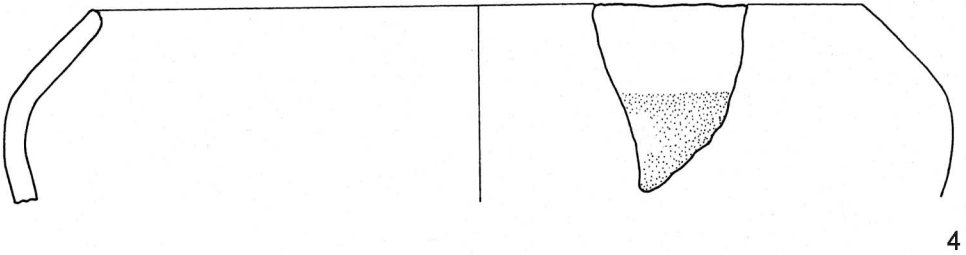
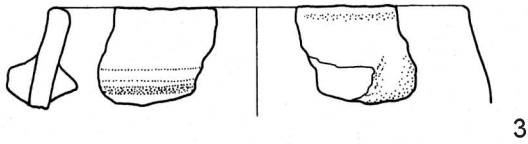
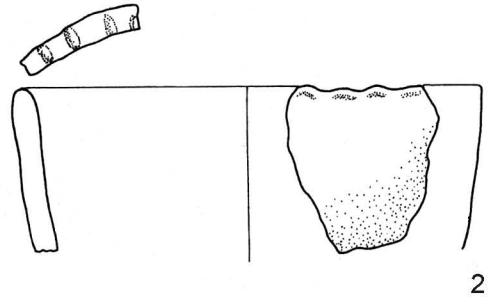
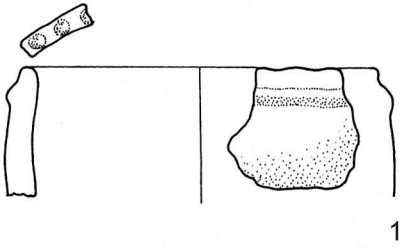

Tav. 43 - Santa Rosa di Poviglio: materiali ceramici provenienti dal pozzo US 1548; 1-6) da US 1559 (scala 1:3).

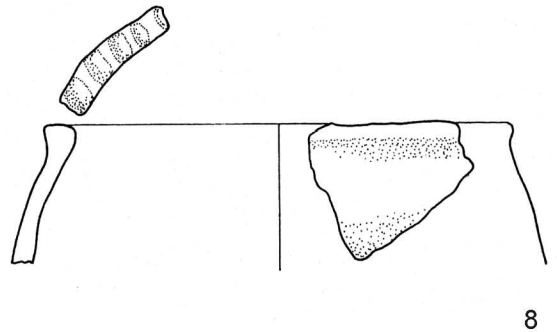
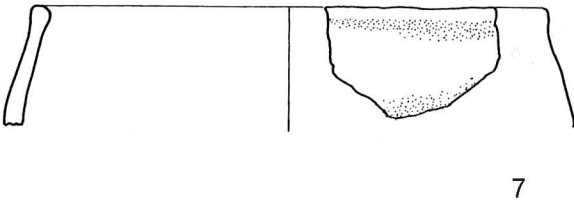
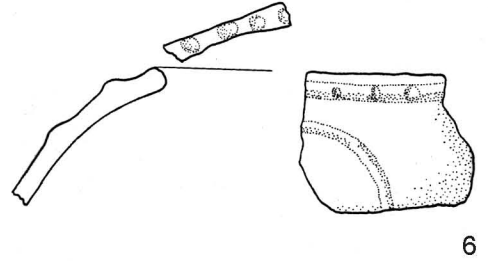
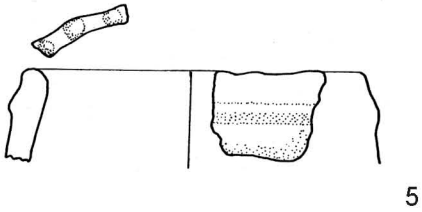
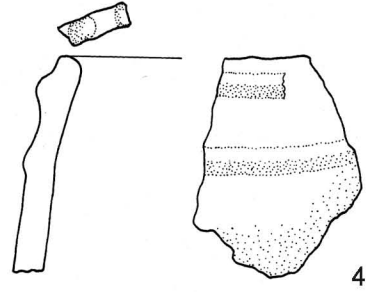
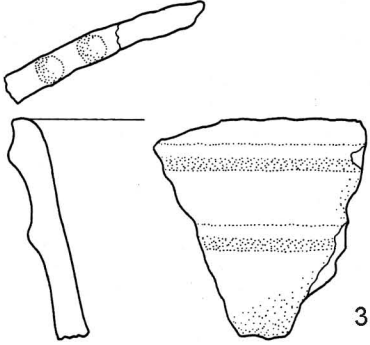
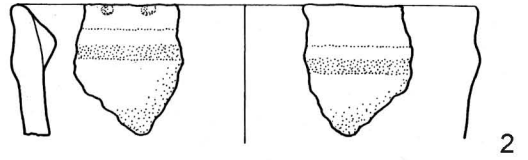
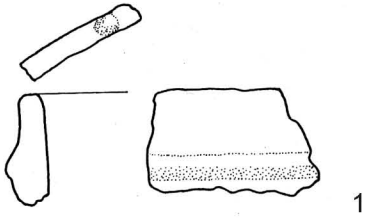

Tav. 44 - Santa Rosa di Poviglio: materiali ceramici provenienti dal pozzo US 1548; 1-8) da US 1542 (scala 1:3).

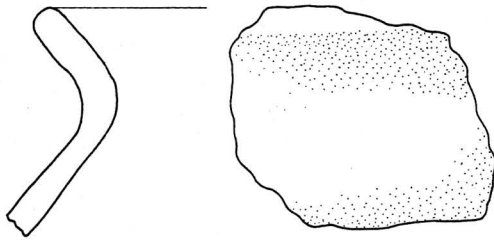

1

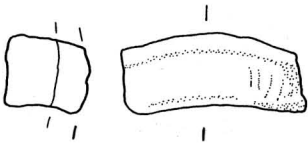

2

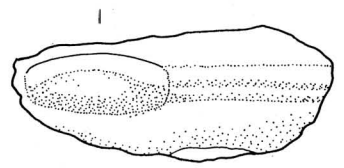
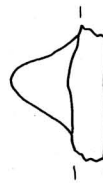

3

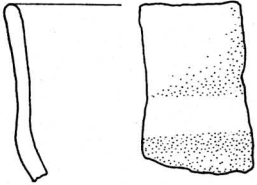

4

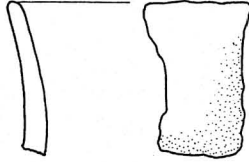

5

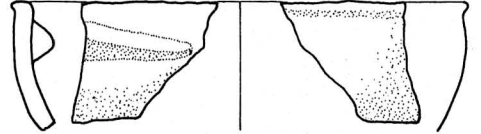

6

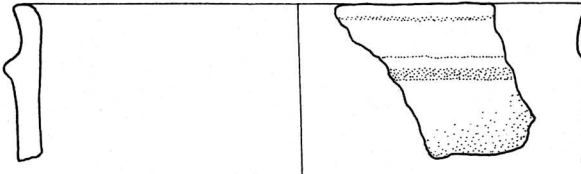

7

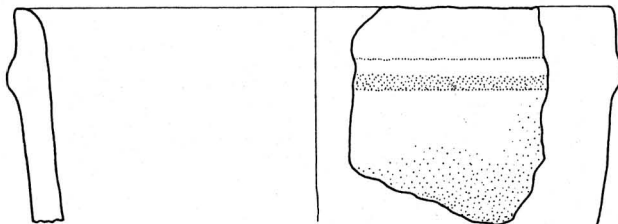
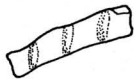

8

Tav. 45 - Santa Rosa di Poviglio: materiali ceramici provenienti dal pozzo US 1548; 1-3) da US 1542; 4-8) da US 1500 (scala 1:3).

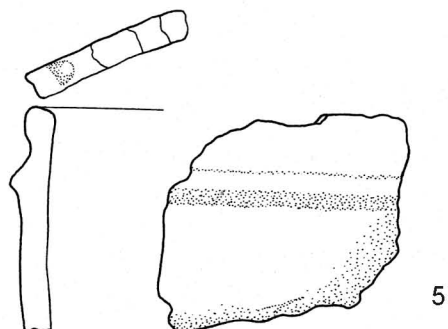
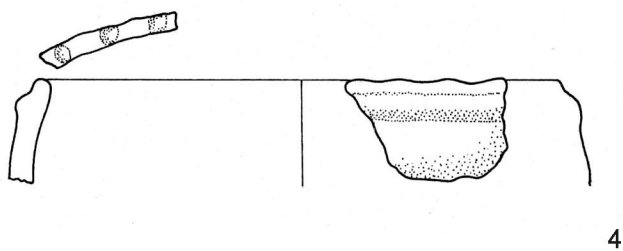
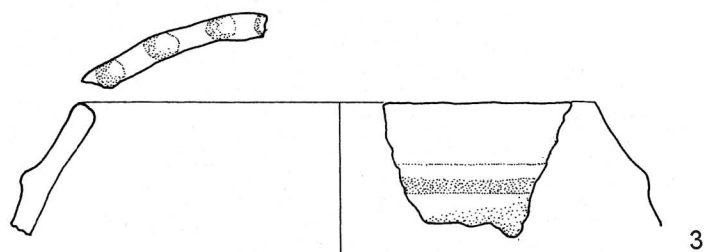
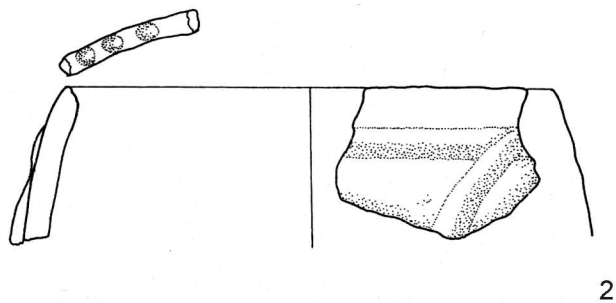
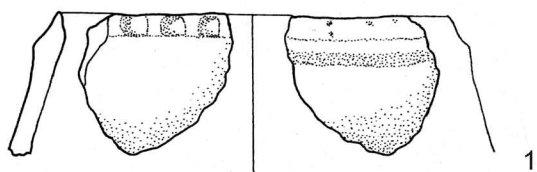

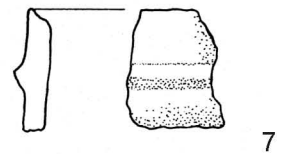
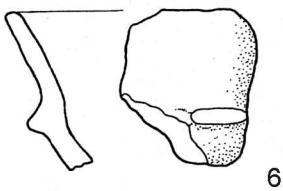
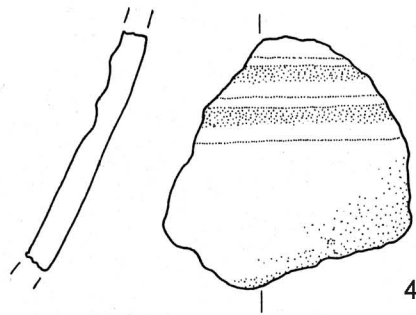
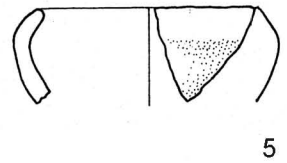
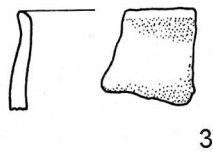
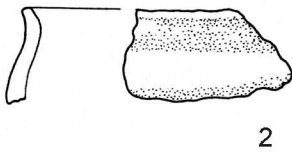
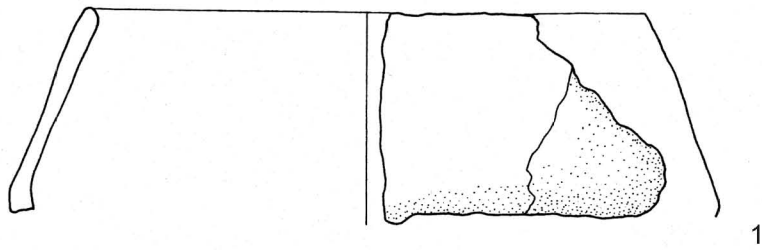

Tav. 47 - Santa Rosa di Poviglio: materiali ceramici provenienti dal pozzo US 1548; 1-5) da US 1500; 6-7) da US 1502 (scala 1:3).

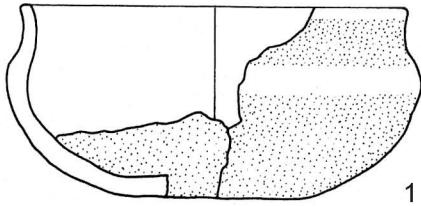

1

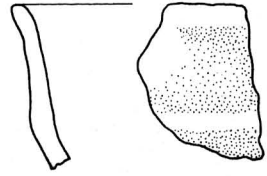

2

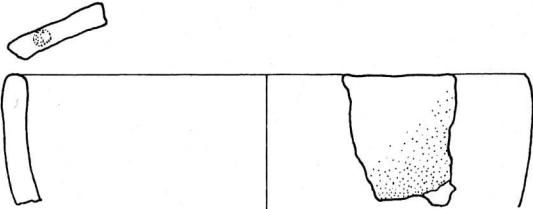

3

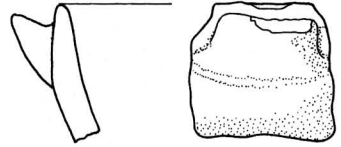

4

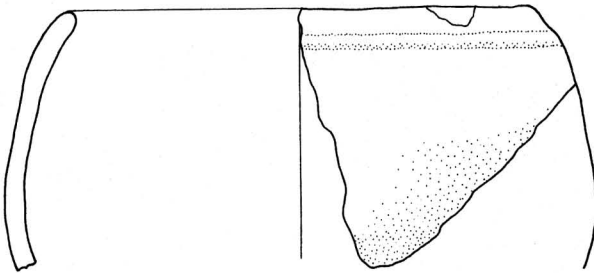

5

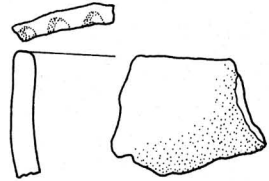

6

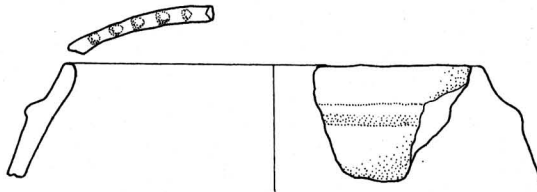

8

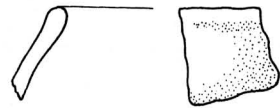

7

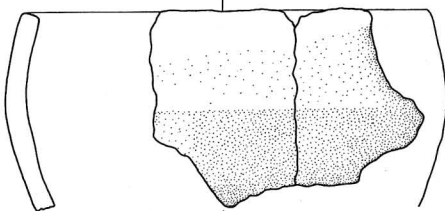

9

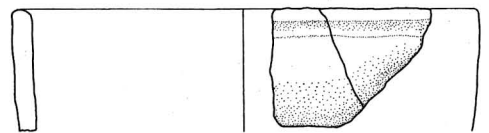

10

Tav. 48 - Santa Rosa di Poviglio: materiali ceramici provenienti dal pozzo US 1712; 1-8) da US 1715; materiali ceramici provenienti dal pozzo US 5340; 9-10) da US 5343 (scala 1:3).

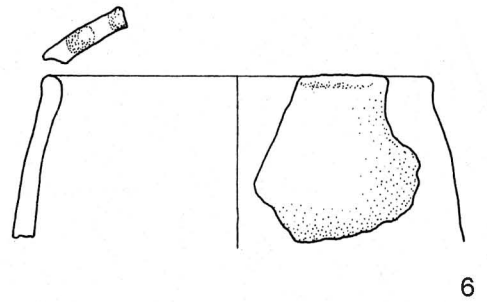
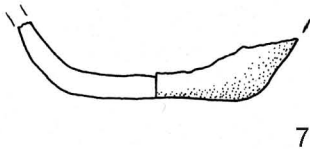
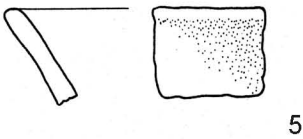
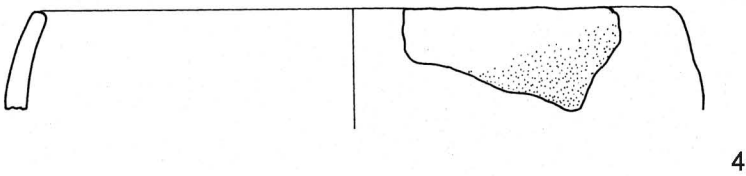
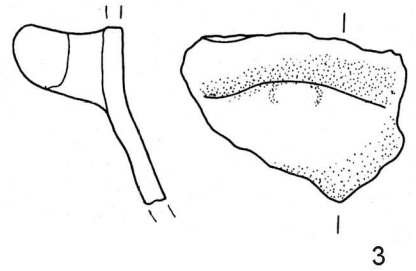
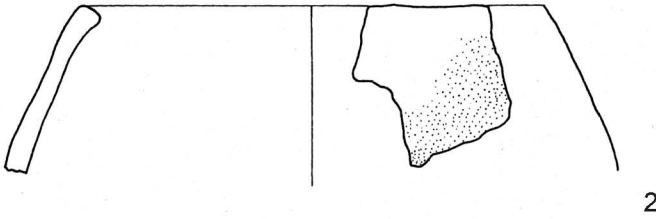
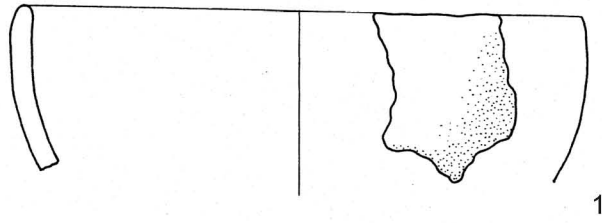

Tav. 49 - Santa Rosa di Poviglio: materiali ceramici provenienti dal pozzo US 1426; 1-4) da US 1488; 5-7) da US 1483 (scala 1:3).

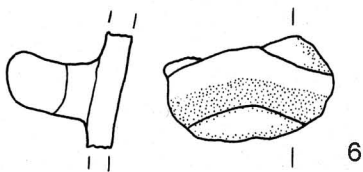
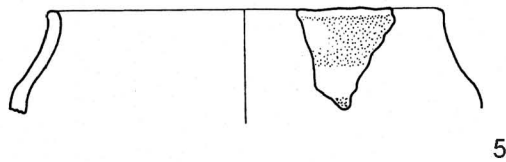
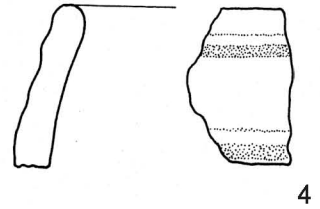
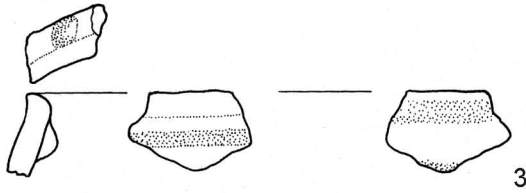
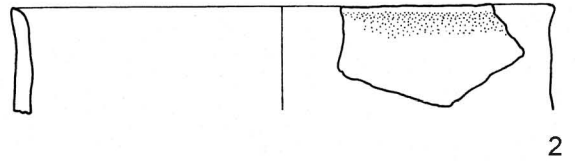
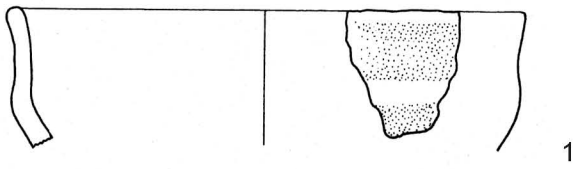

Tav. 50 - Santa Rosa di Poviglio: materiali ceramici provenienti dal pozzo US 1426; 1-7) da US 1473 (scala 1:3).

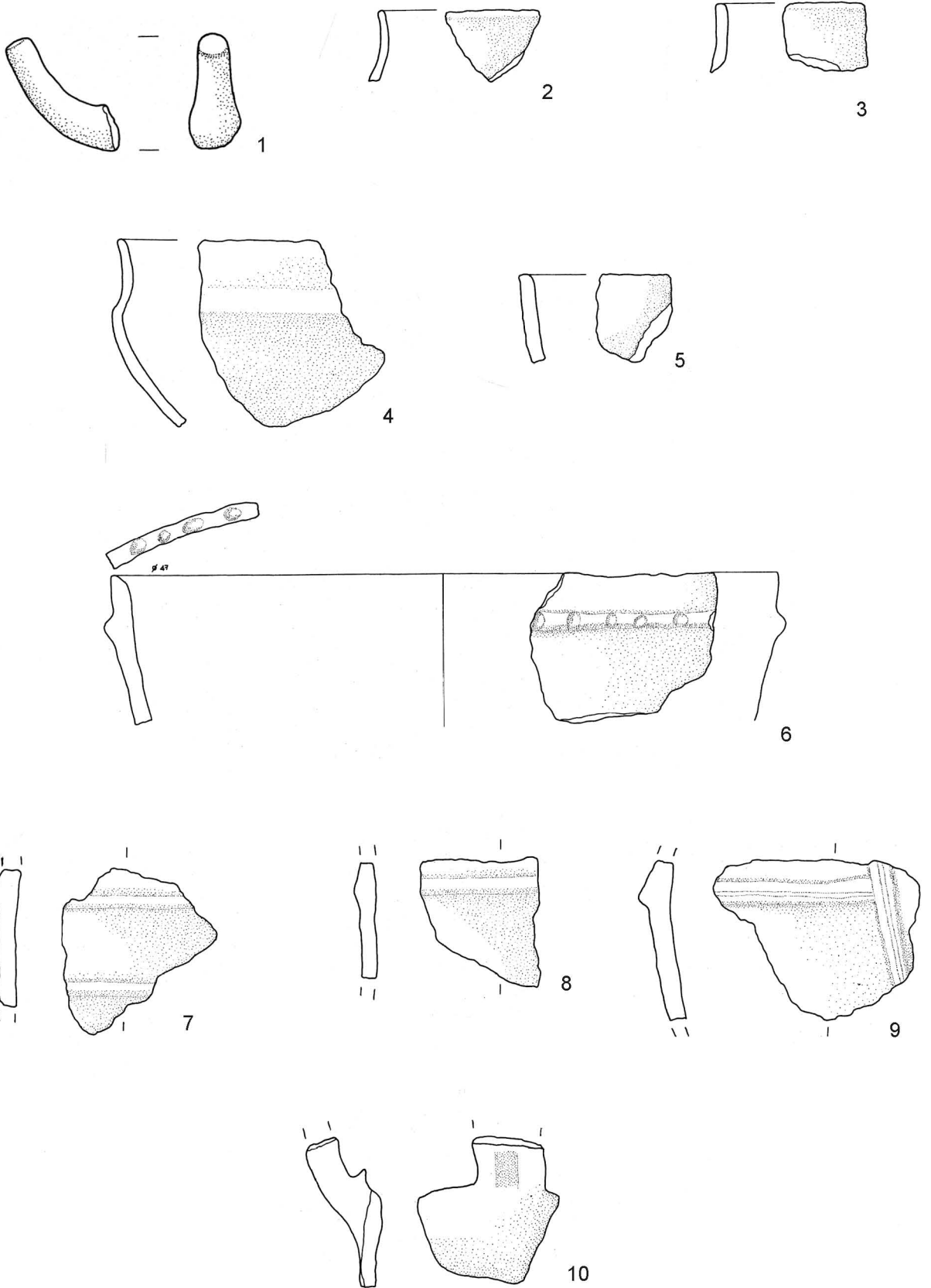

Tav. 51 - Santa Rosa di Poviglio: materiali ceramici provenienti dal pozzo US 5245; 1) da US 5307; 2-10) da US 5281 (scala 1:3).

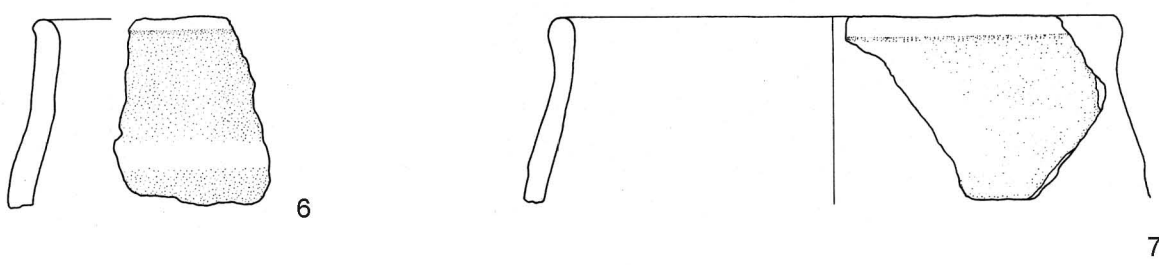
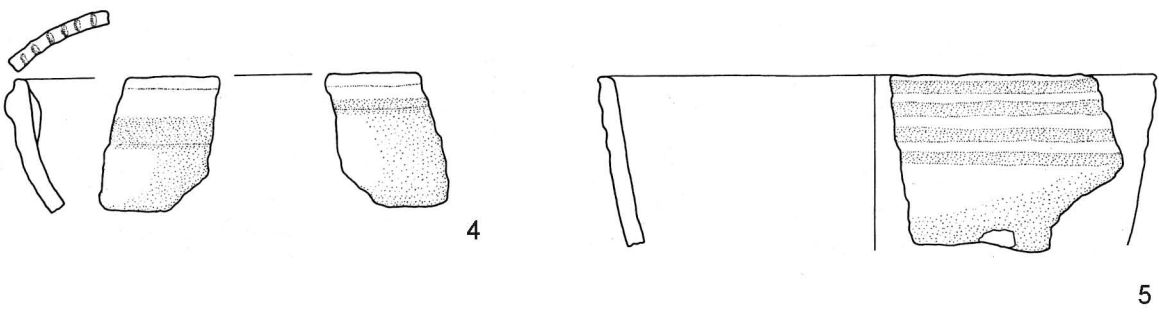
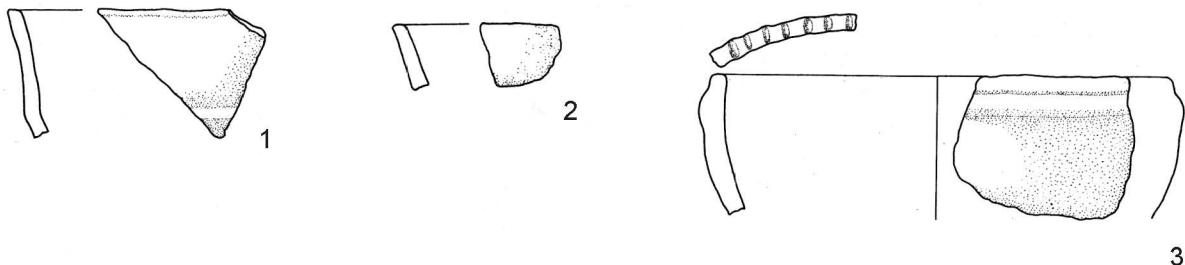

Tav. 52 - Santa Rosa di Poviglio: materiali ceramici provenienti dal pozzo US 5223; 1-11) da US 5222 (scala 1:3).

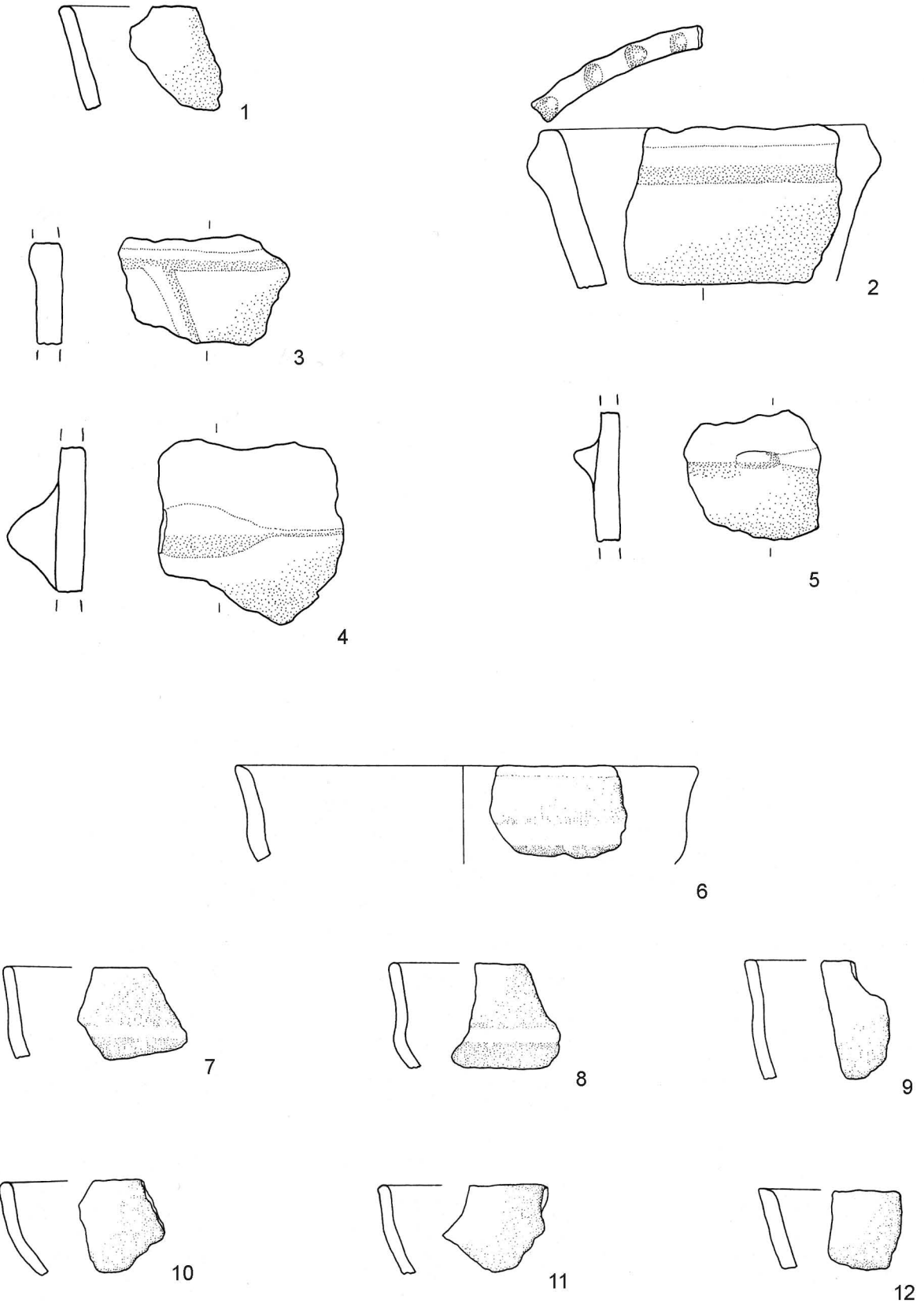

Tav. 53 - Santa Rosa di Poviglio: materiali ceramici provenienti dal pozzo US 5165; 1-5) da US 5291; 6-12) da US 5266 (scala 1:3).

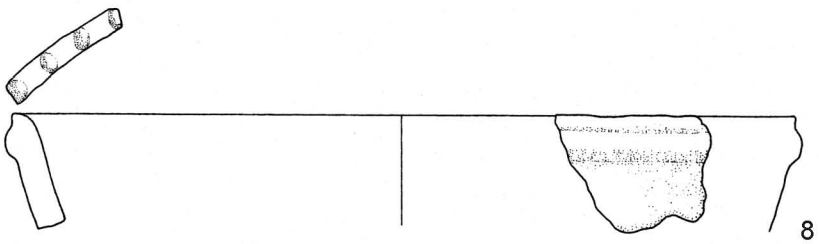
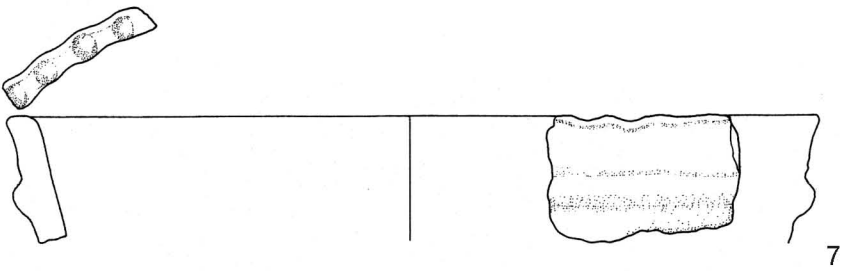
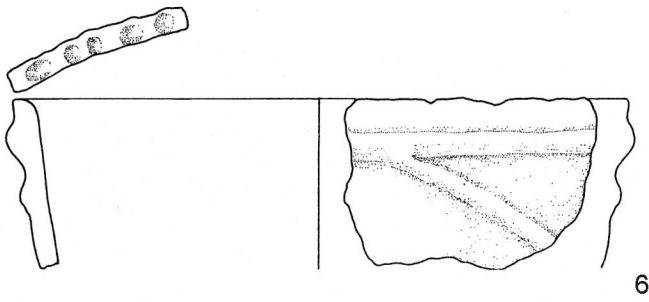
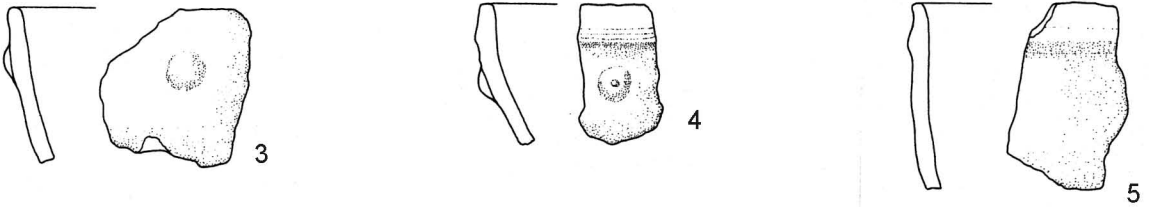
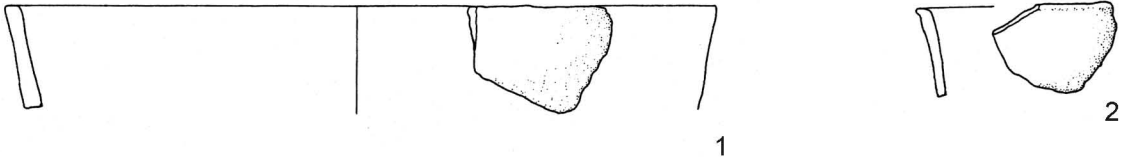

Tav. 54 - Santa Rosa di Poviglio: materiali ceramici provenienti dal pozzo US 5165; 1-8) da US 5266 (scala 1:3).

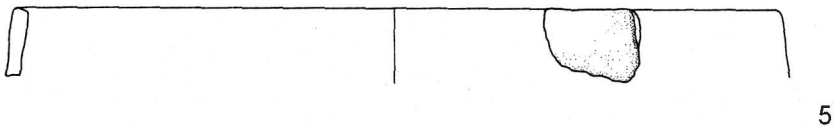
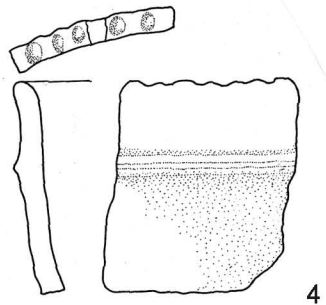
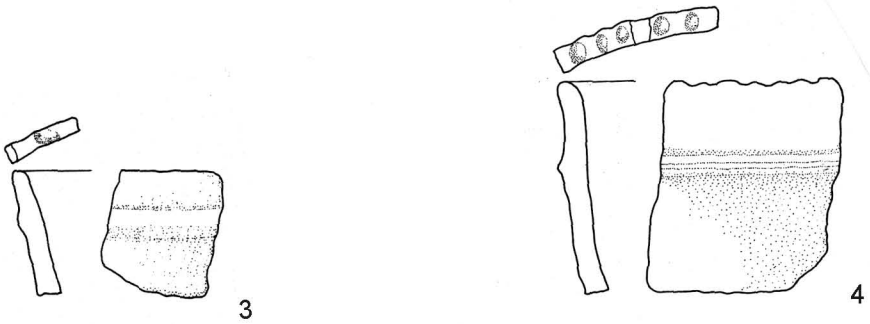
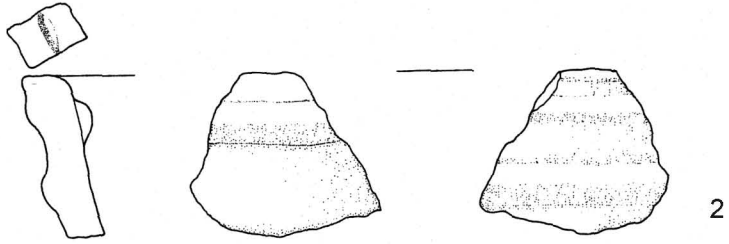
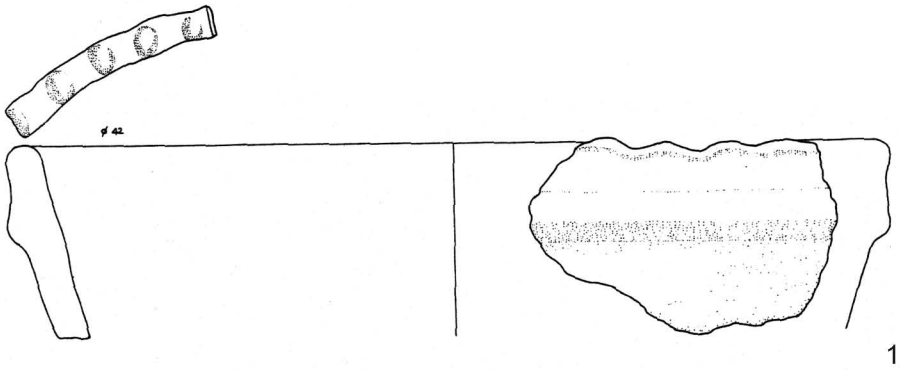

Tav. 55 - Santa Rosa di Poviglio: materiali ceramici provenienti dal pozzo US 5165; 1-5) da US 5266 (scala 1:3).

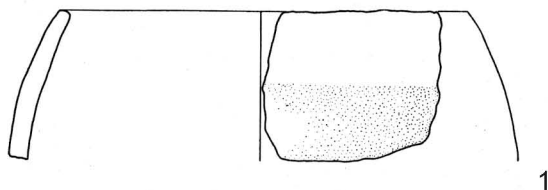

1

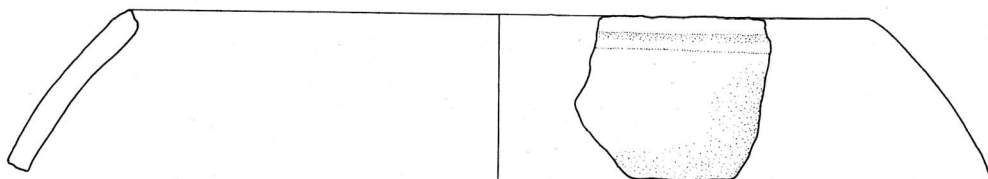

2

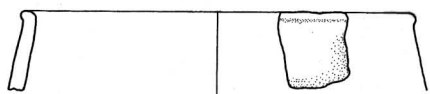

3

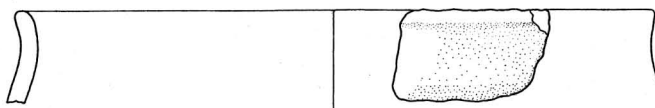

4

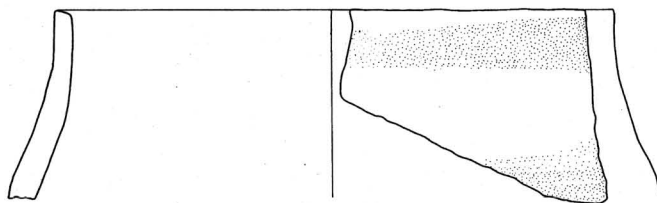

5

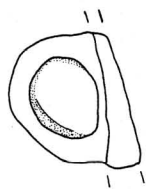

6



7



8

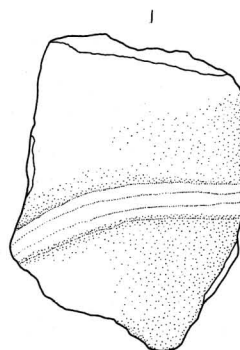

Tav. 56 - Santa Rosa di Poviglio: materiali ceramici provenienti dal pozzo US 5165; 1-8) da US 5266 (scala 1:3).

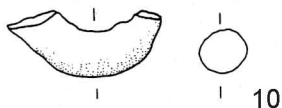
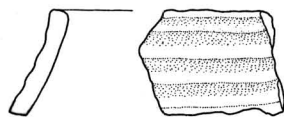
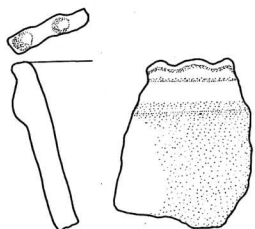
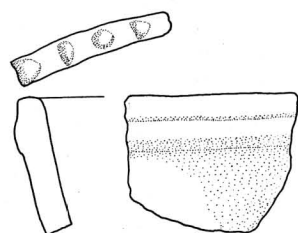
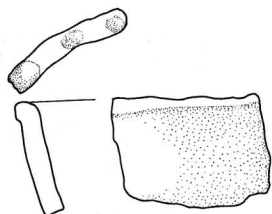
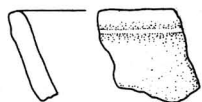
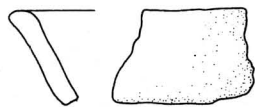
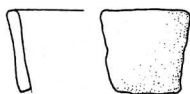
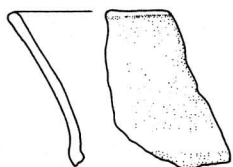
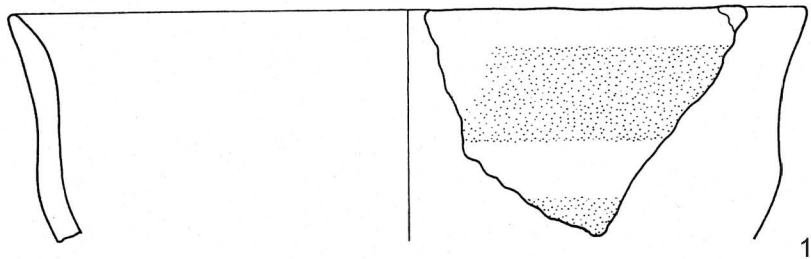

Tav. 57 - Santa Rosa di Poviglio: materiali ceramici provenienti dal pozzo US 5165; 1-11) da US 5267 (scala 1:3).

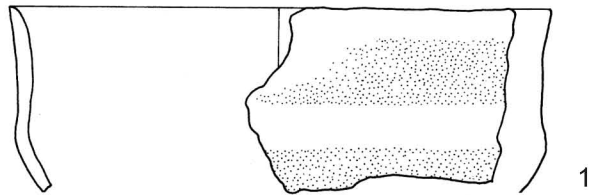

1

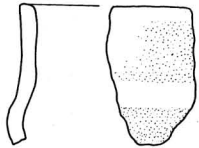

2

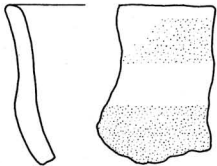

3

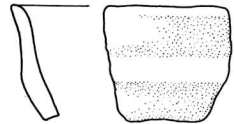

4

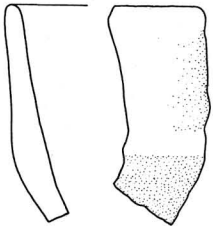

5

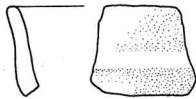

6

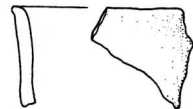

7

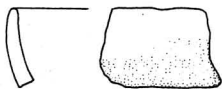

8

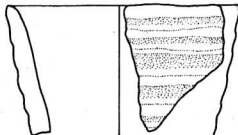

9



10

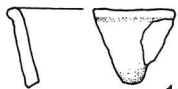

11



12

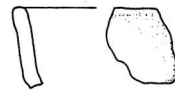

13

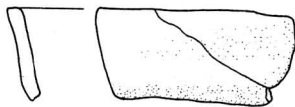

14

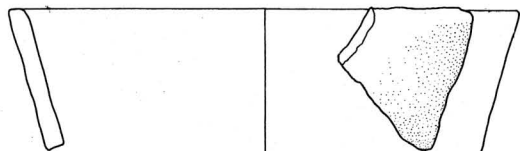

15

Tav. 58 - Santa Rosa di Poviglio: materiali ceramici provenienti dal pozzo US 5165; 1-15 da US 5259 (scala 1:3).

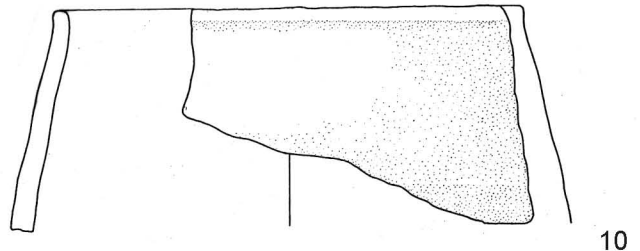
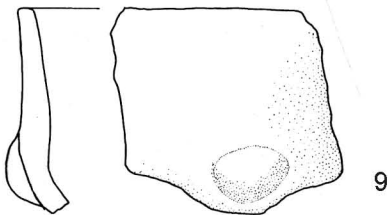
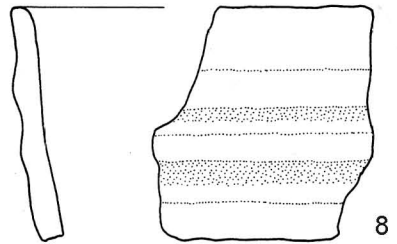
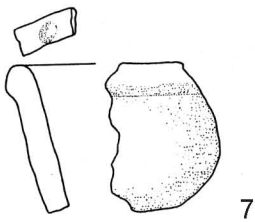
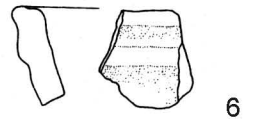
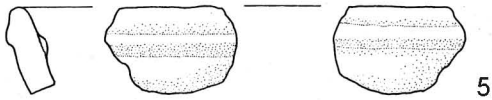
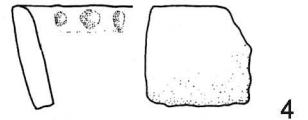
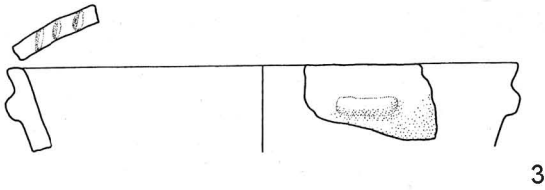
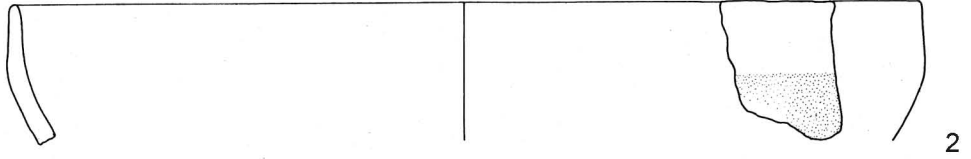
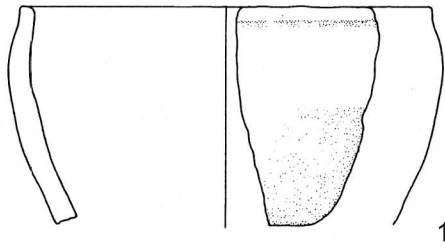

Tav. 59 - Santa Rosa di Poviglio: materiali ceramici provenienti dal pozzo US 5165; 1-10) da US 5259 (scala 1:3).

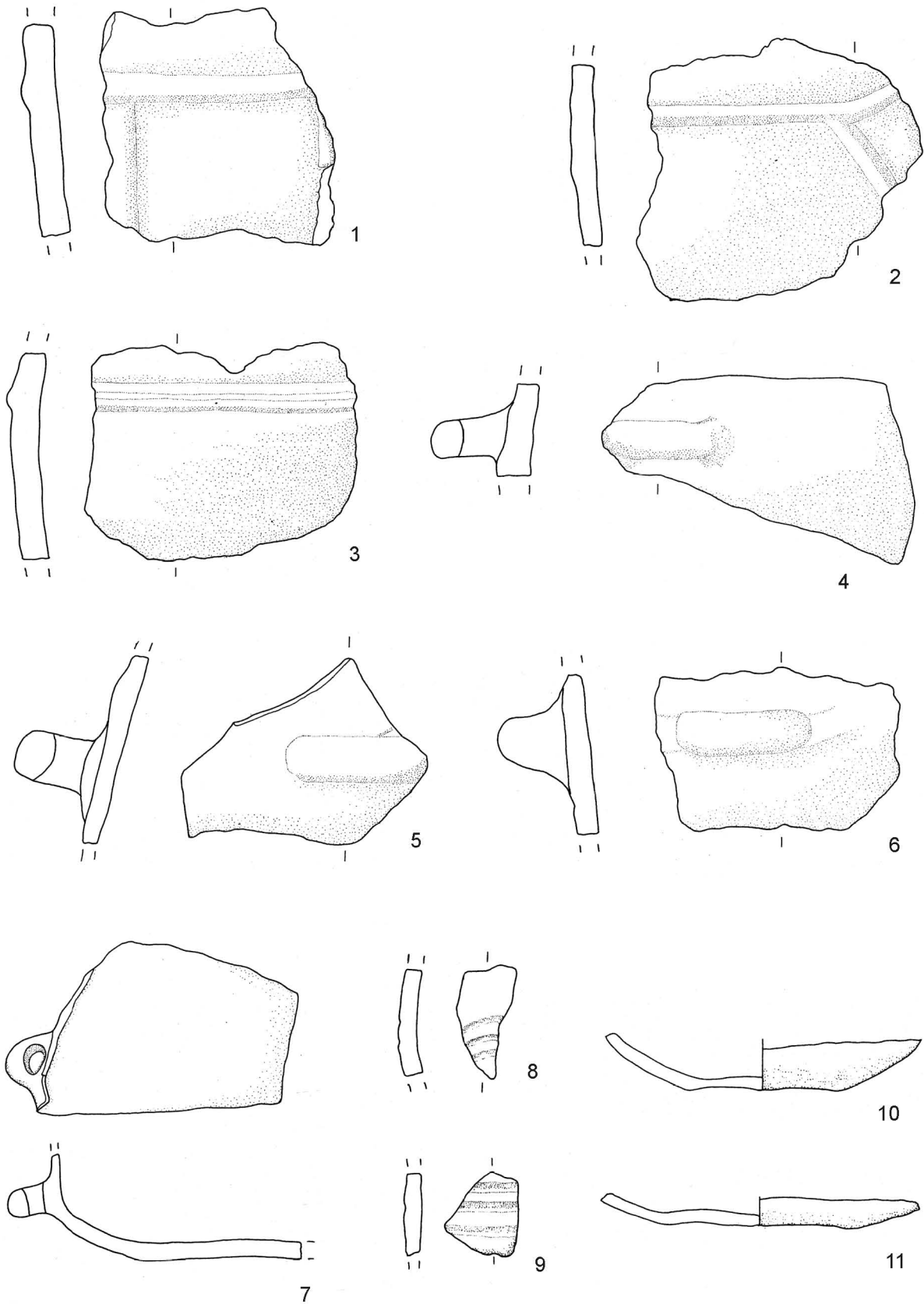

Tav. 60 - Santa Rosa di Poviglio: materiali ceramici provenienti dal pozzo US 5165; 1-11) da US 5259 (scala 1:3).

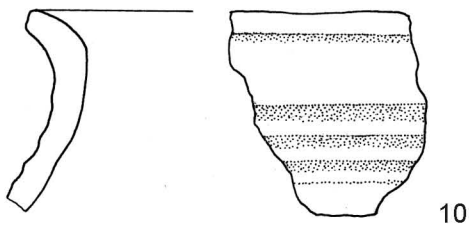
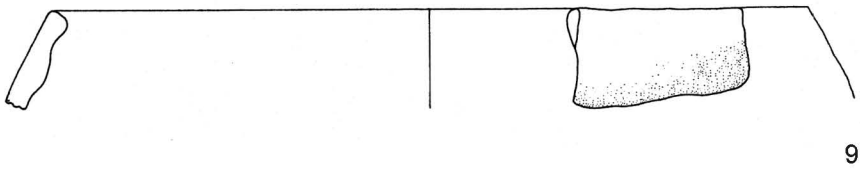
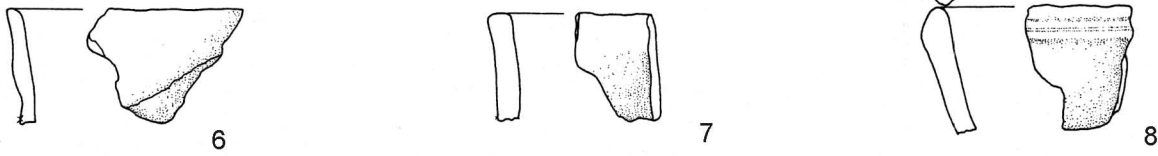
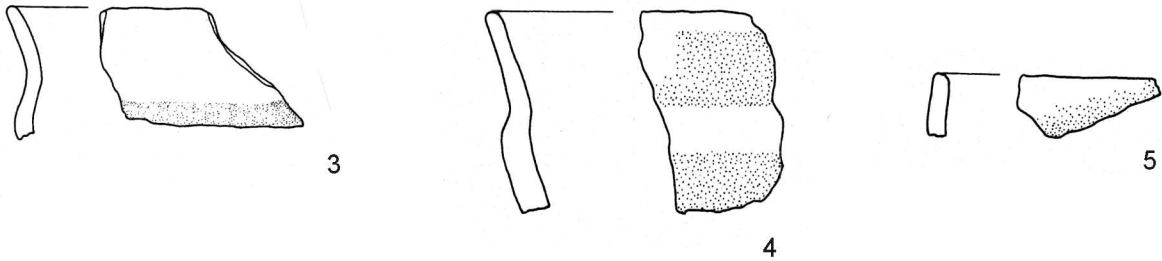

Tav. 61 - Santa Rosa di Poviglio: materiali ceramici provenienti dal pozzo US 5165; 1-10) da US 5166 (scala 1:3).

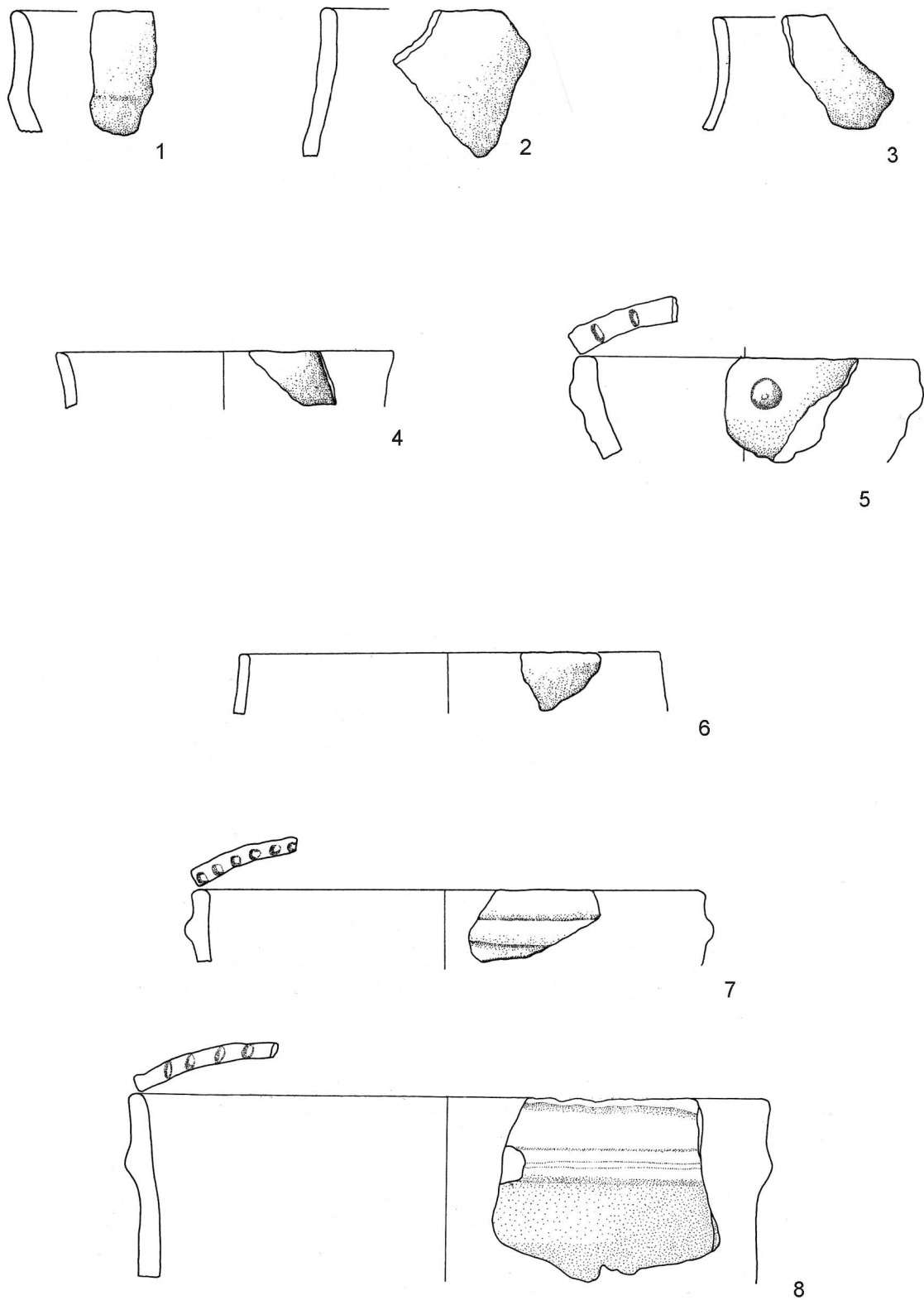

Tav. 62 - Santa Rosa di Poviglio: materiali ceramici provenienti dalla canaletta US 5167; 1-8) da US 5166 (scala 1:3).

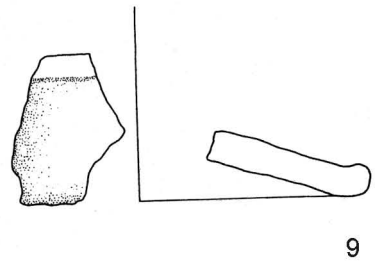
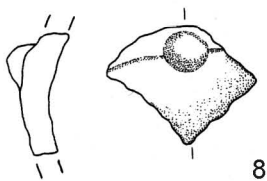
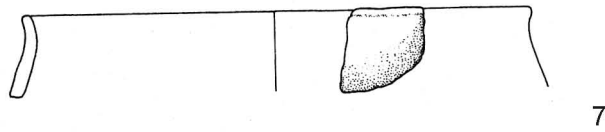
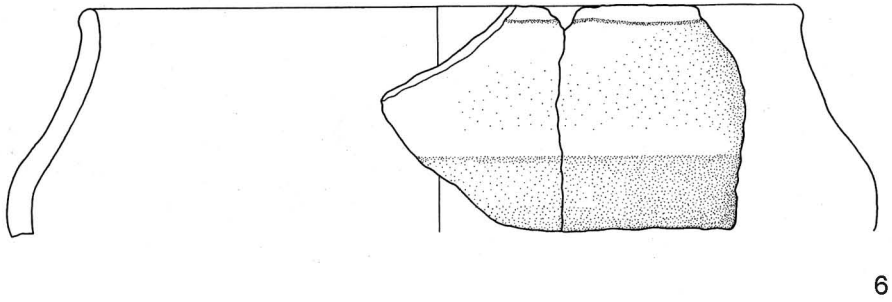
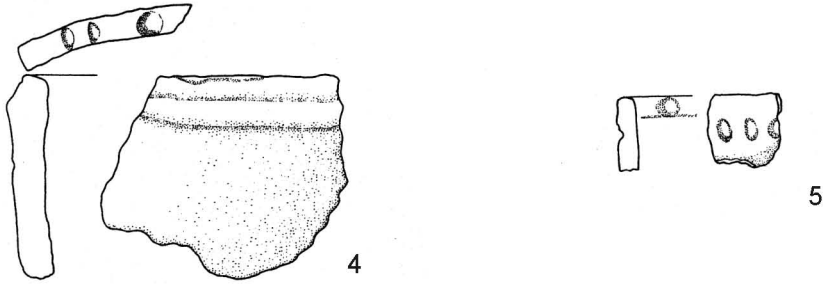
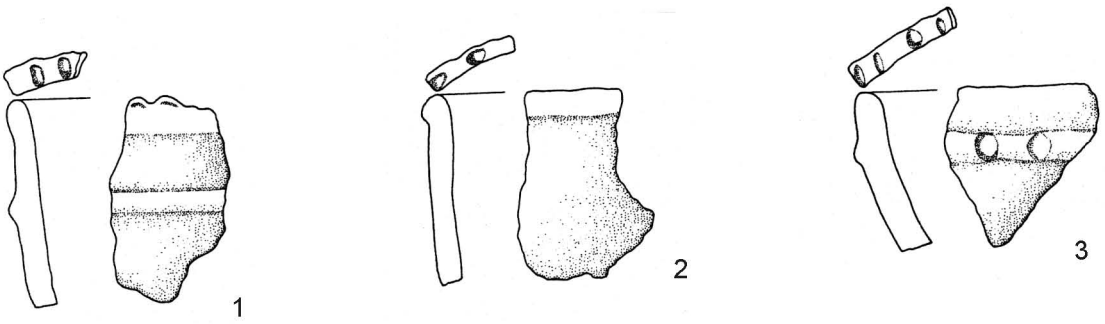

Tav. 63 - Santa Rosa di Poviglio: materiali ceramici provenienti dalla canaletta US 5167; 1-9) da US 5166 (scala 1:3).

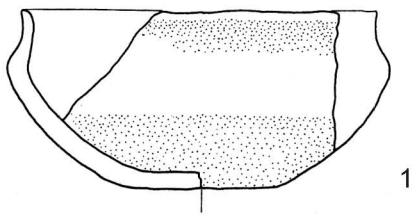

1

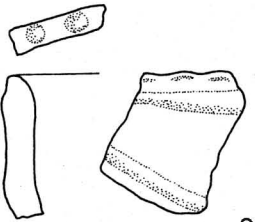

2

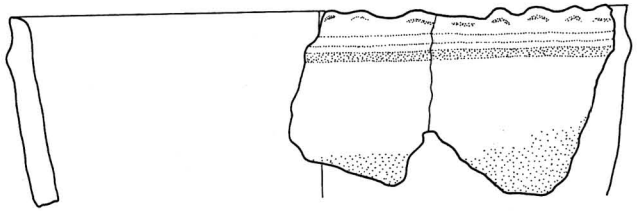

3

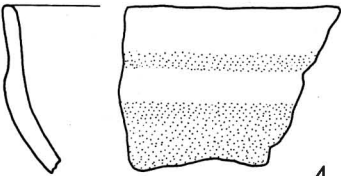

4

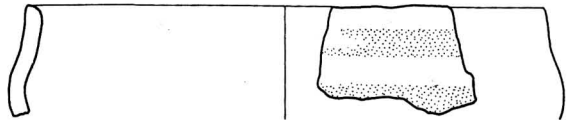

5

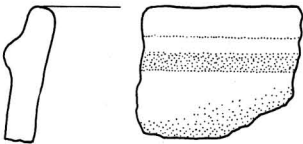

6

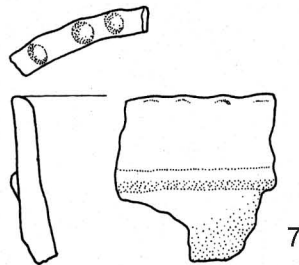

7

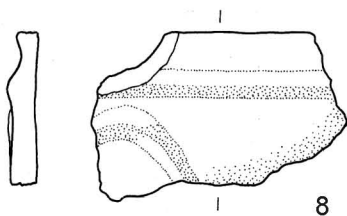
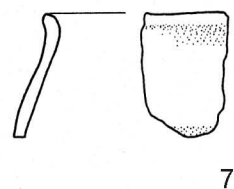
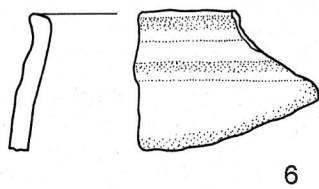
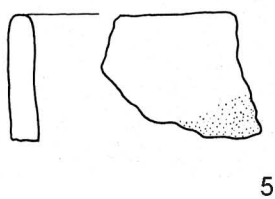
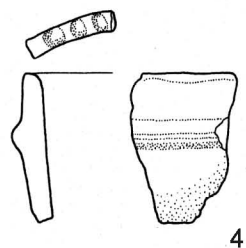
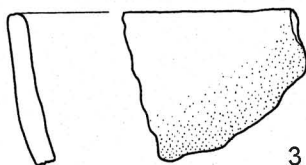
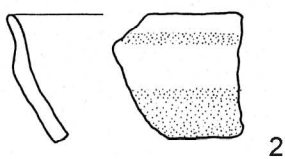
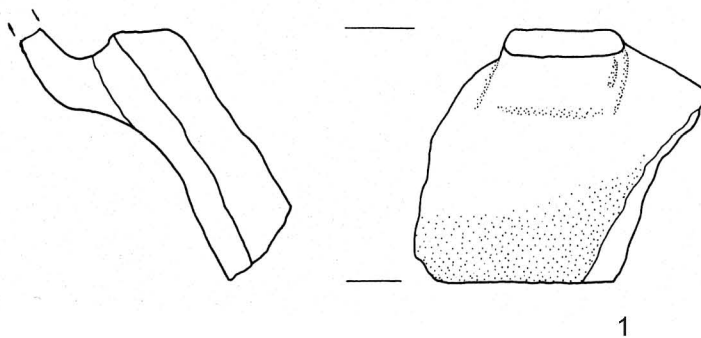

Tav. 65 - Santa Rosa di Poviglio: materiali ceramici provenienti dal pozzo US 5600; 1) da US 5618; 2-8) da US 5599 (scala 1:3).

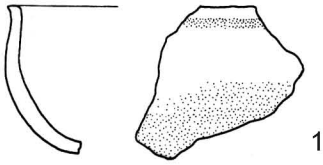

1

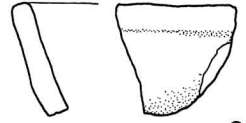

2

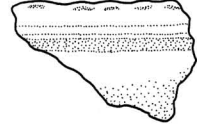
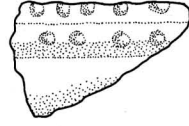
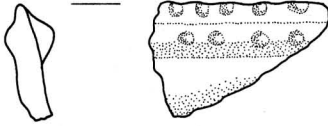

3

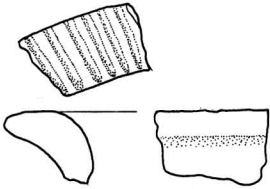

4

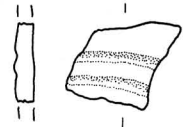

5

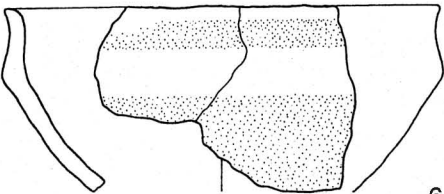

6

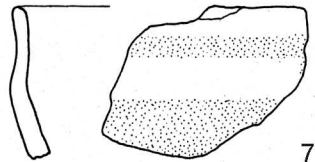

7

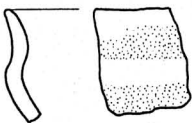

8

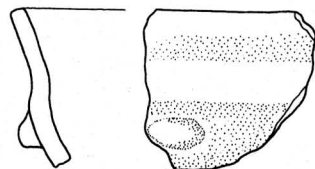

9

Tav. 66 - Santa Rosa di Poviglio: materiali ceramici provenienti dal pozzo US 5622; 1-5) da US 200; 6-9) da US 5639 (scala 1:3).

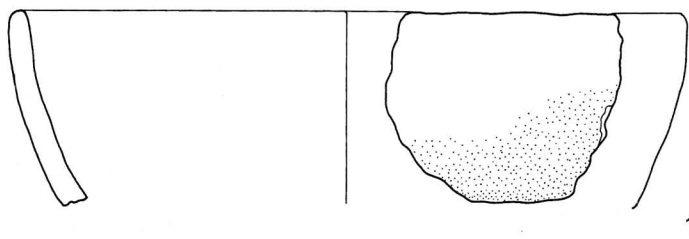

1

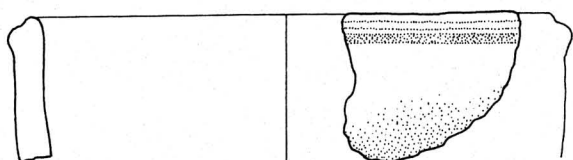

2

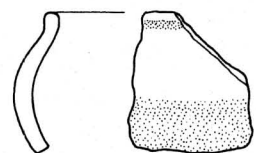

3

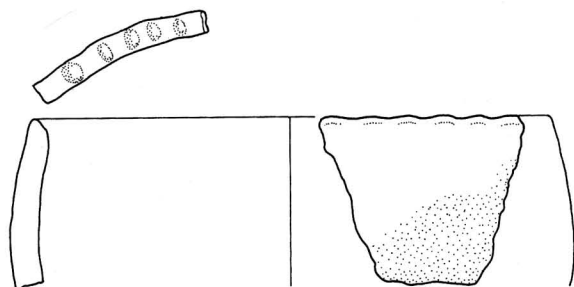

4

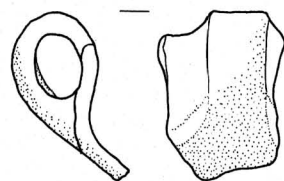

5

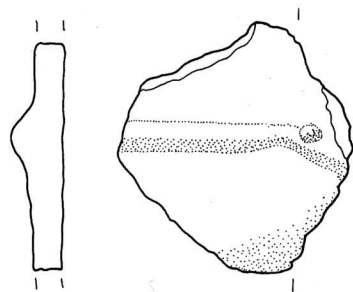

6

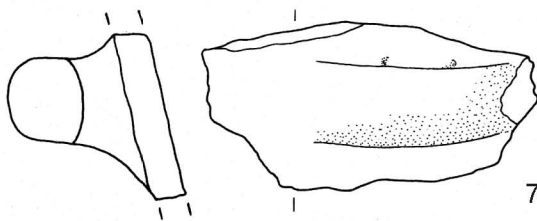

7

Tav. 67 - Santa Rosa di Poviglio: materiali ceramici provenienti dal pozzo US 5622; 1-5) da US 5639; 6) da US 5633; 7) da US 5631 (scala 1:3).

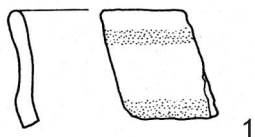

1

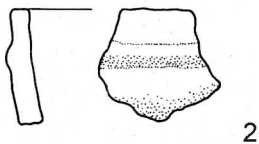

2

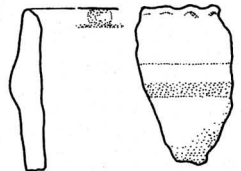

3

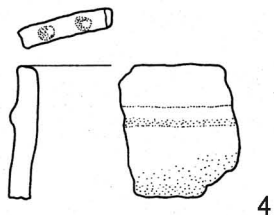

4

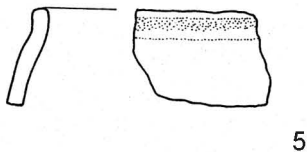

5



6

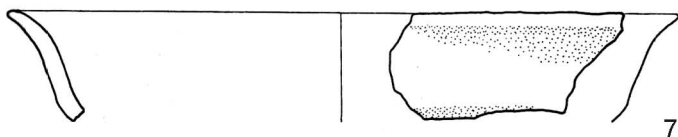

7

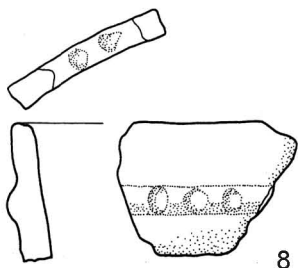

8

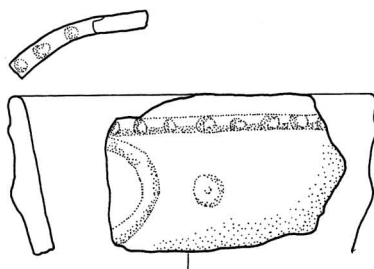

9

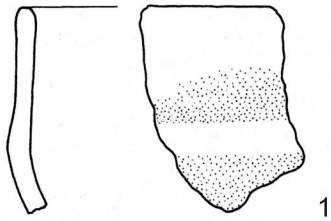

1

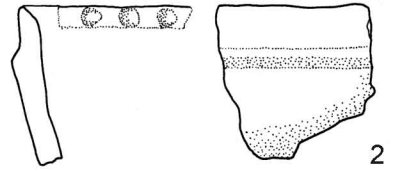

2

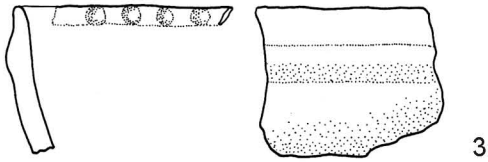

3

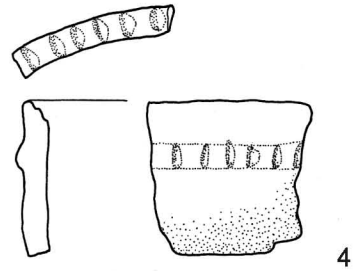

4

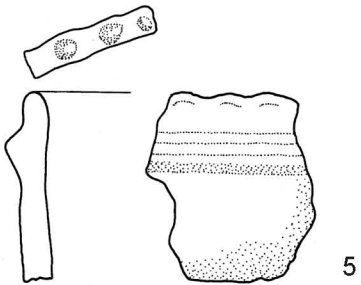

5

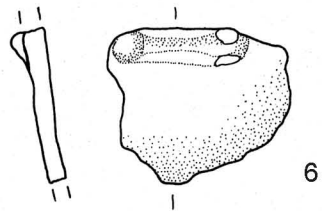

6

Tav. 69 - Santa Rosa di Poviglio: materiali ceramici provenienti dal pozzo US 5622; 1-6) da US 5611 (scala 1:3).

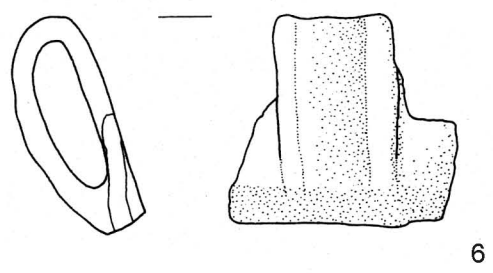
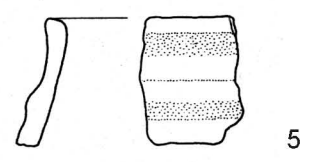
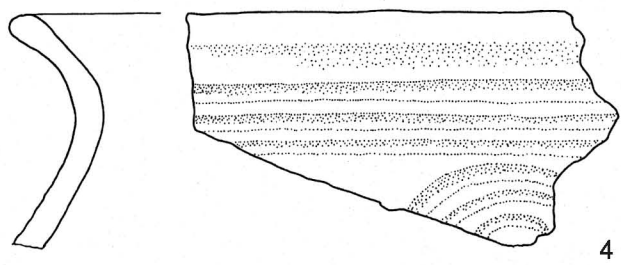
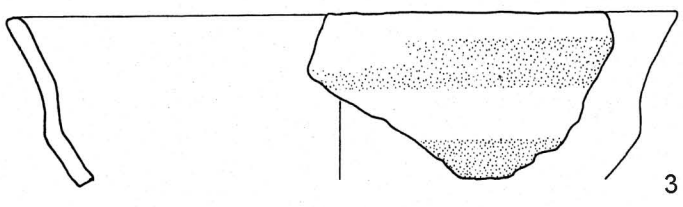
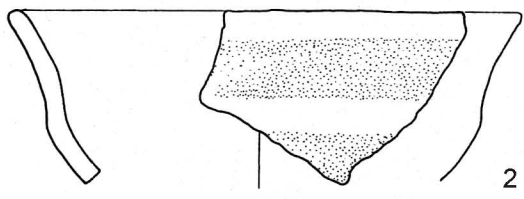
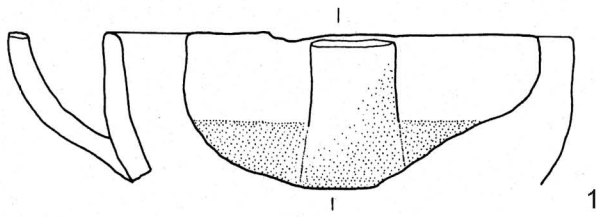

Tav. 70 - Santa Rosa di Poviglio: materiali ceramici provenienti dal pozzo US 5776; 1) da US 5794; 2-6) da US 5763 (scala 1:3).

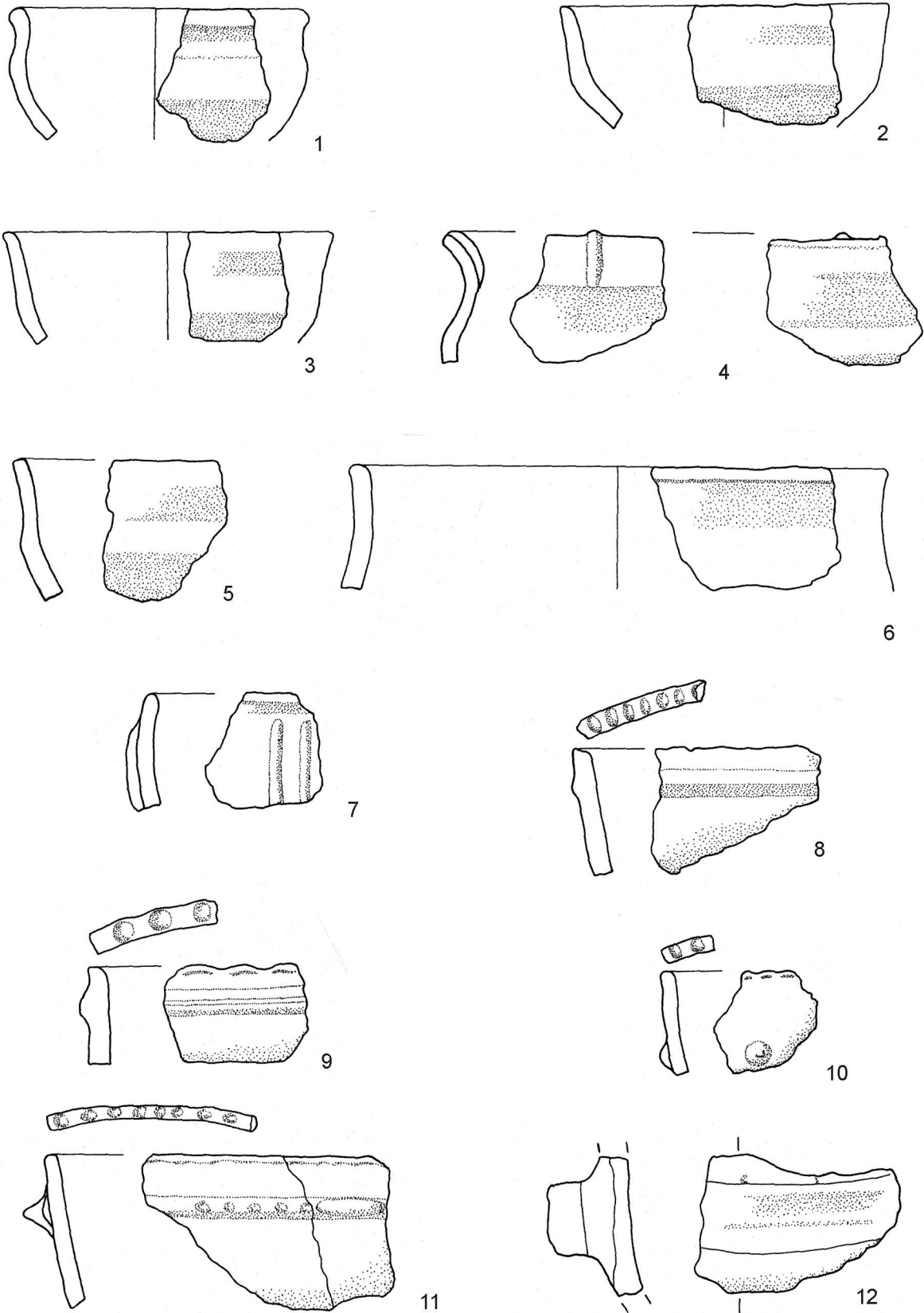

Tav. 71 - Santa Rosa di Poviglio: materiali ceramici provenienti dal canale US 1879; 1-12) da US 1923 (scala 1:3).

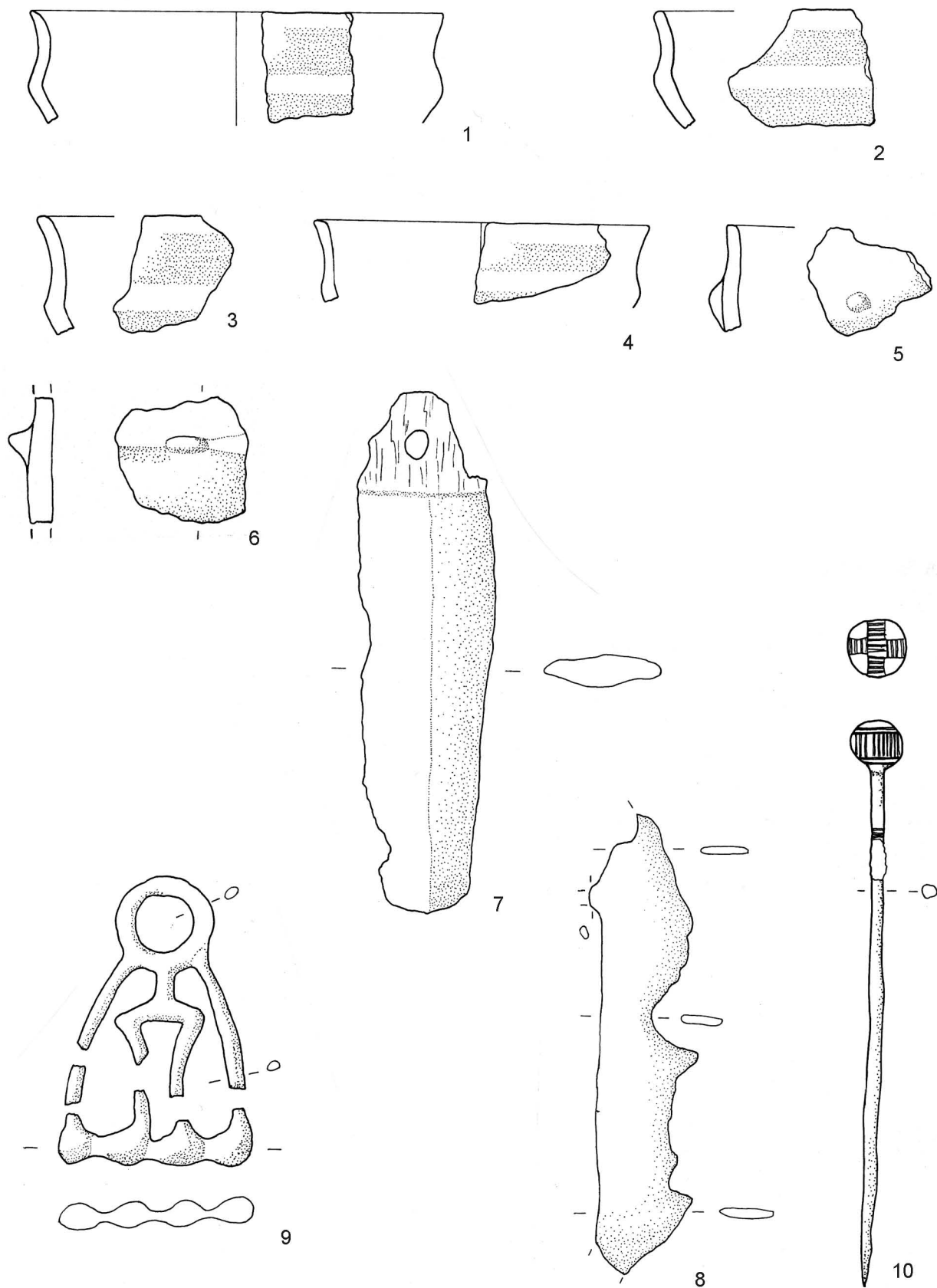

Tav. 72 - Santa Rosa di Poviglio: materiali ceramici provenienti dal pozzo US 2628 (=6015); 1-6) da US 2629; oggetti in bronzo provenienti dalle strutture della recinzione; 7 e 8) da US 2144; 9) da US 1889; 10) da US 6010 (nn° 1-6 scala 1:3, nn° 7-10 grandezza naturale).

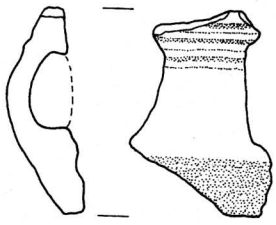

1

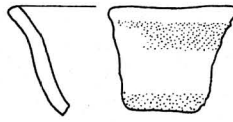

2

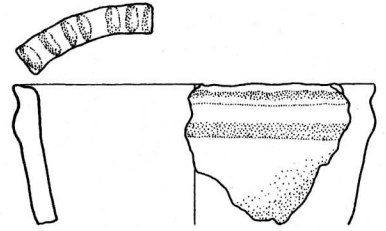

3

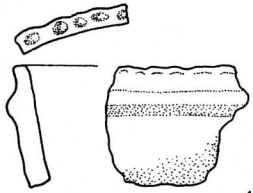

4

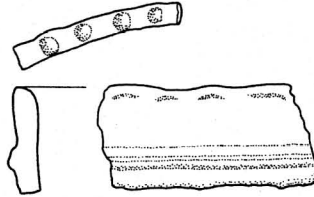

5



6

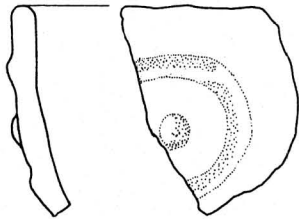

7

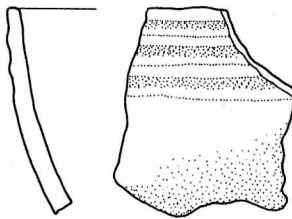

8

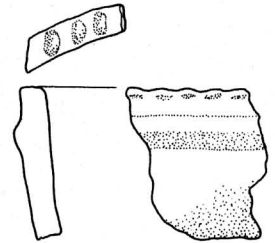

9

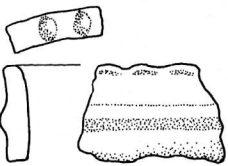

10



11

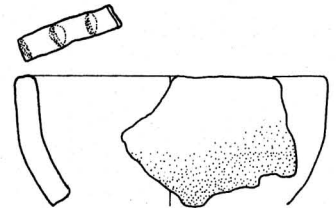

12

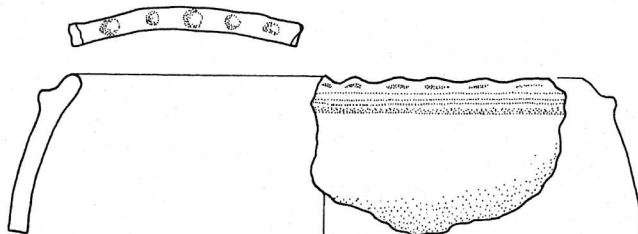

13

Tav. 73 - Santa Rosa di Poviglio: materiali provenienti dall'unità US 1049; 1-6) CH-CL 172-173; 7-13) CH-CL 179-180 (nn° 1-5, 7-13 scala 1:3; n° 6 scala 1:2).

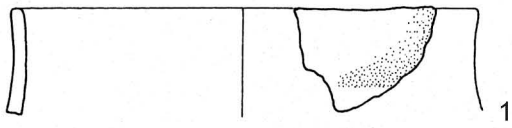

1

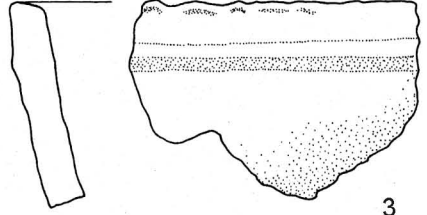
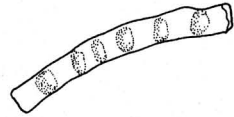

3

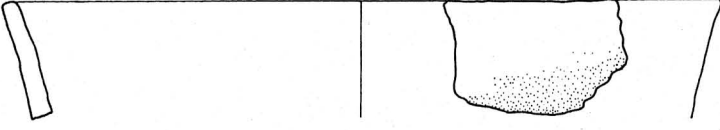

2

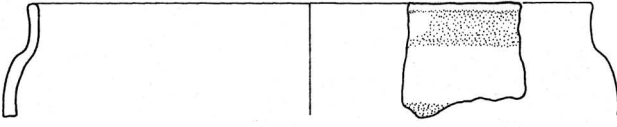

4

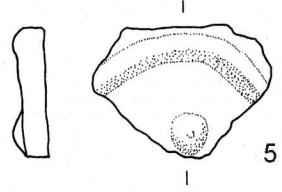

5



6

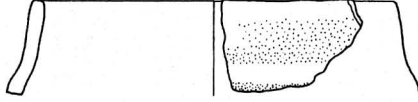

7

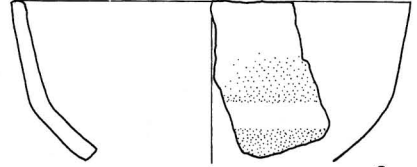

8

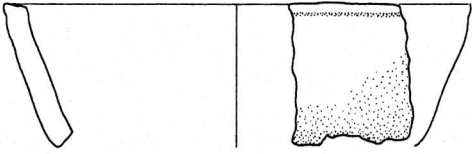
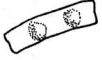

9

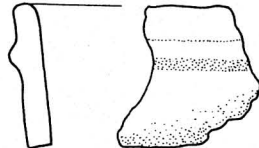

10

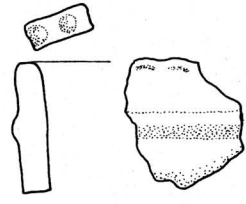

11

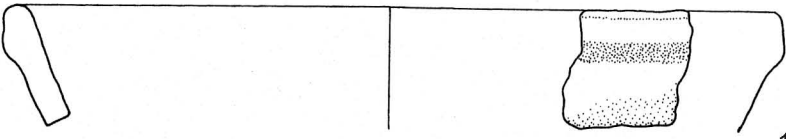

12

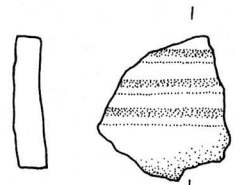

13

Tav. 74 - Santa Rosa di Poviglio: materiali ceramici provenienti dall'unità US 1049; 1-5) CG-CH 177-178; 6-13) CF-CG 171-175 (scala 1:3).

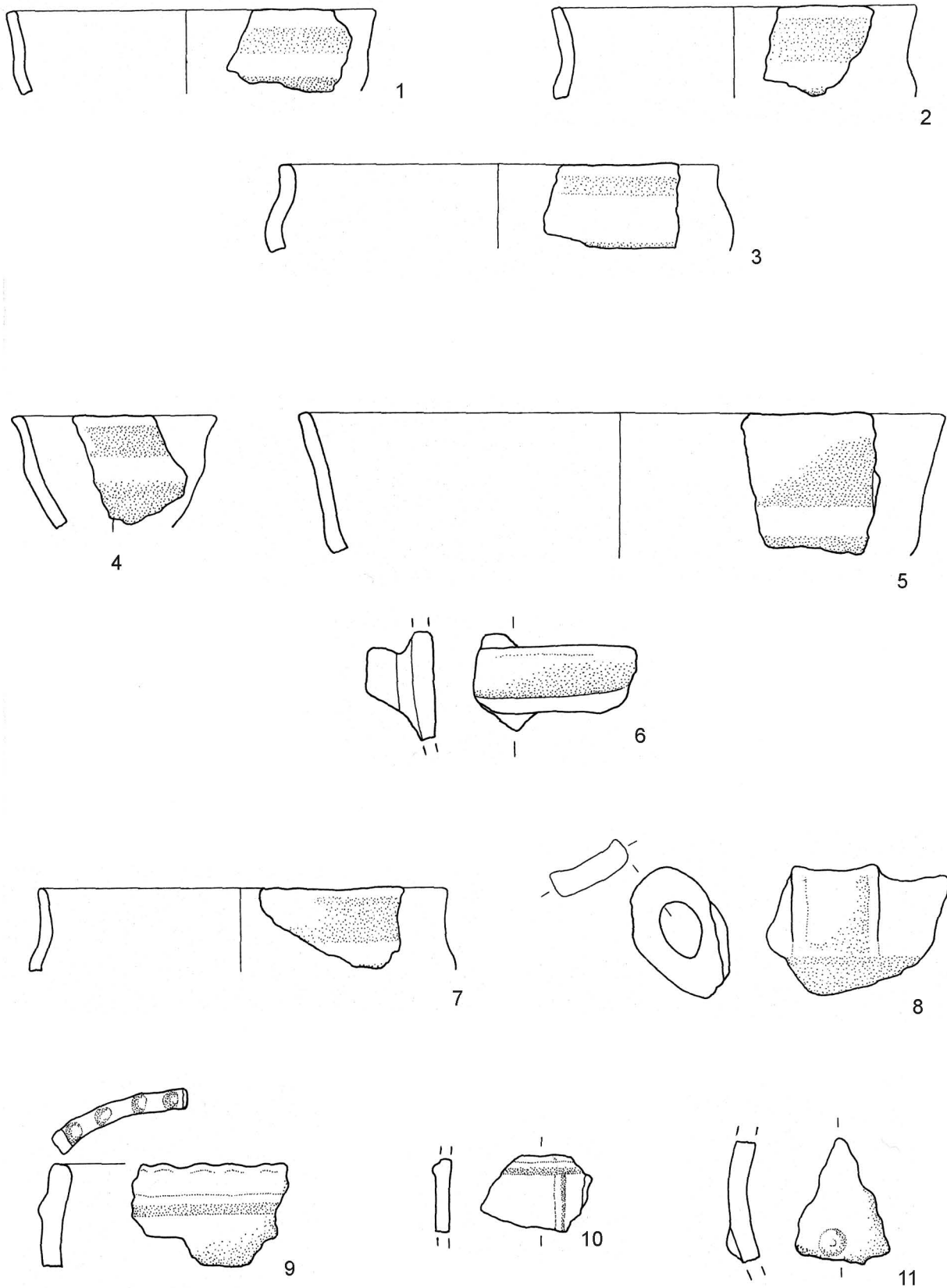

Tav. 75 - Santa Rosa di Poviglio: materiali ceramici provenienti dall'unità US 1049; 1-3) CD-CB 173-174; 4-6) CC-CB 172-175; 7-11) CF-BV 179-181 (scala 1:3).

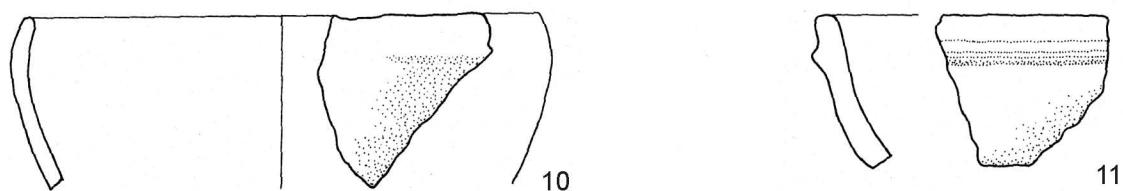
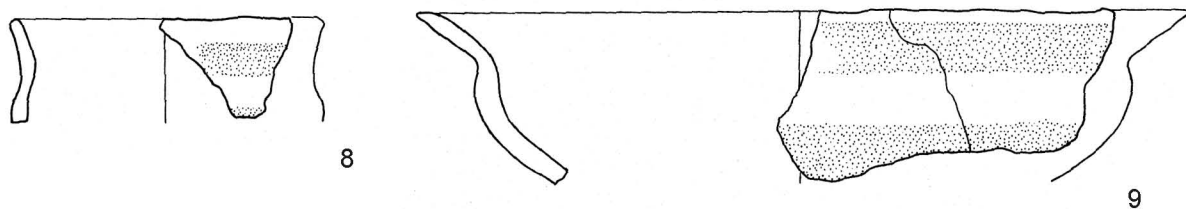
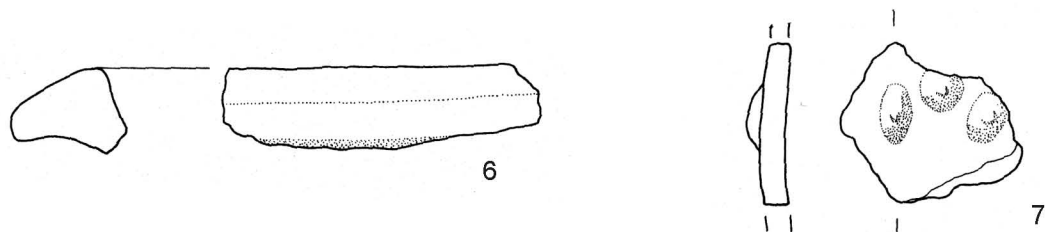
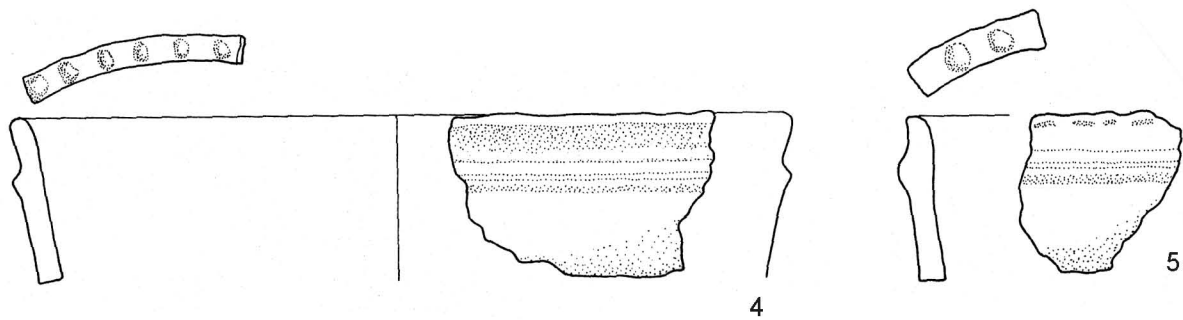
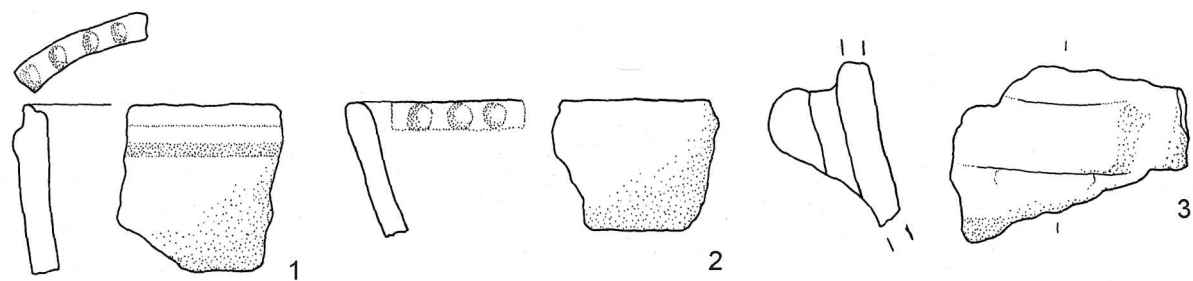

Tav. 76 - Santa Rosa di Poviglio: materiali ceramici provenienti dall'unità US 1049; 1-3) CF-BV 179-181; 4-8) CD-BV 175-176; 9-11) CC-BV 172-174 (scala 1:3).

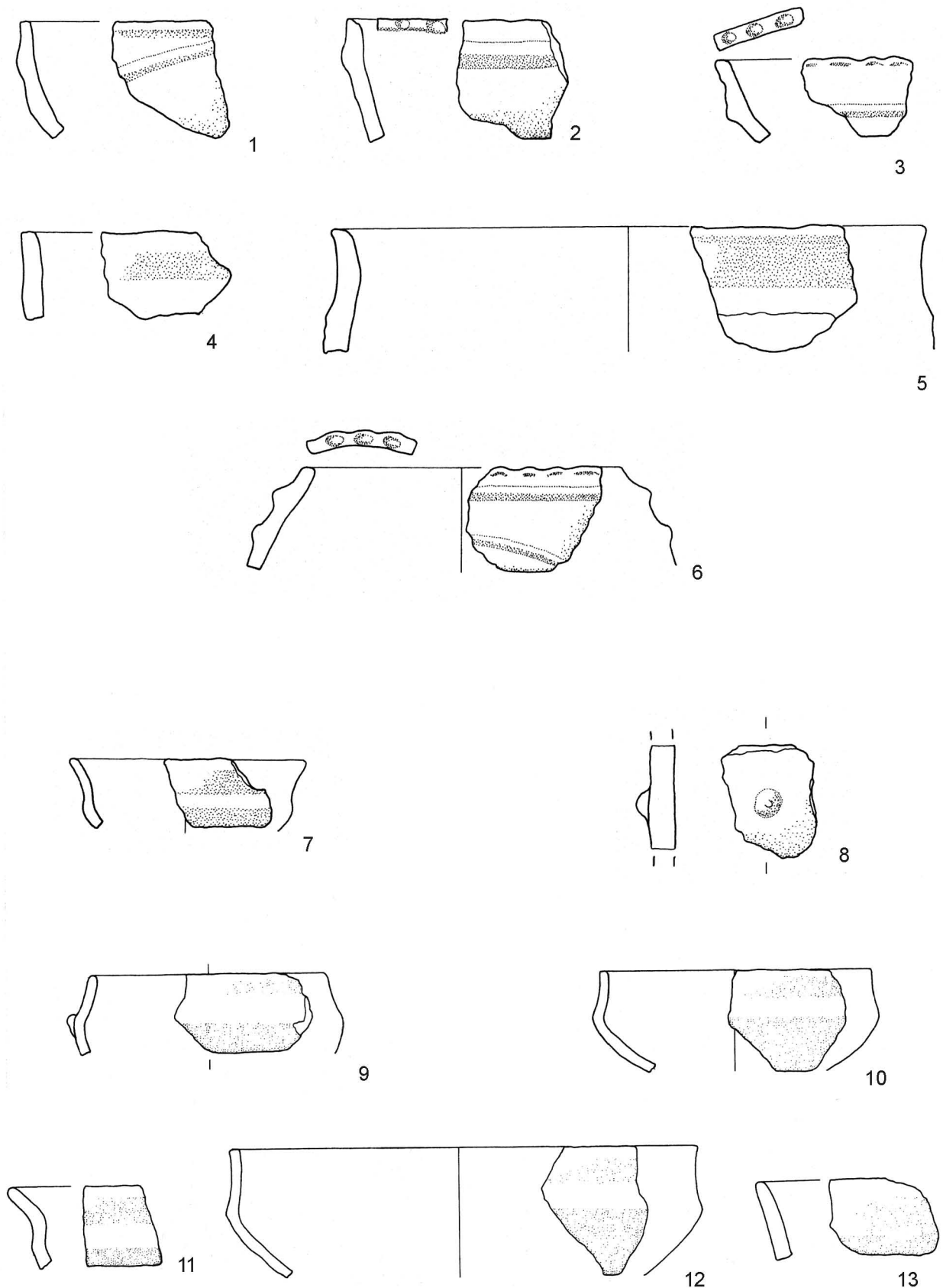

Tav. 77 - Santa Rosa di Poviglio: materiali ceramici provenienti dall'unità US 1049; 1-6) CC-BV 172-174; 7-8) CA-BV 175-178; 9-13) BV-BU 143-152 (scala 1:3).

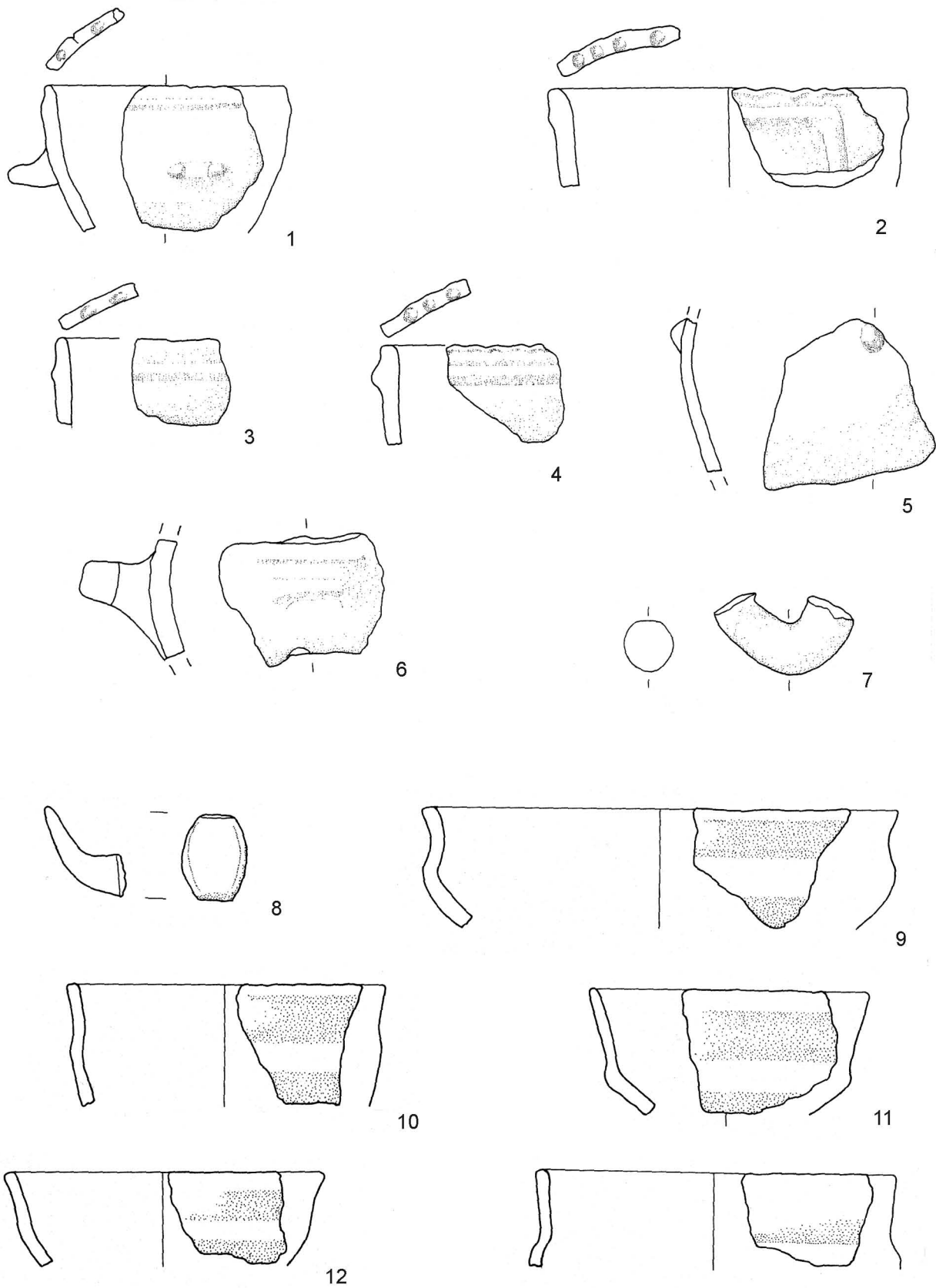

Tav. 78 - Santa Rosa di Poviglio: materiali ceramici provenienti dall'unità US 1049; 1-7) BV-BU 143-152; 8-13) BV-BR 173-178 (scala 1:3).

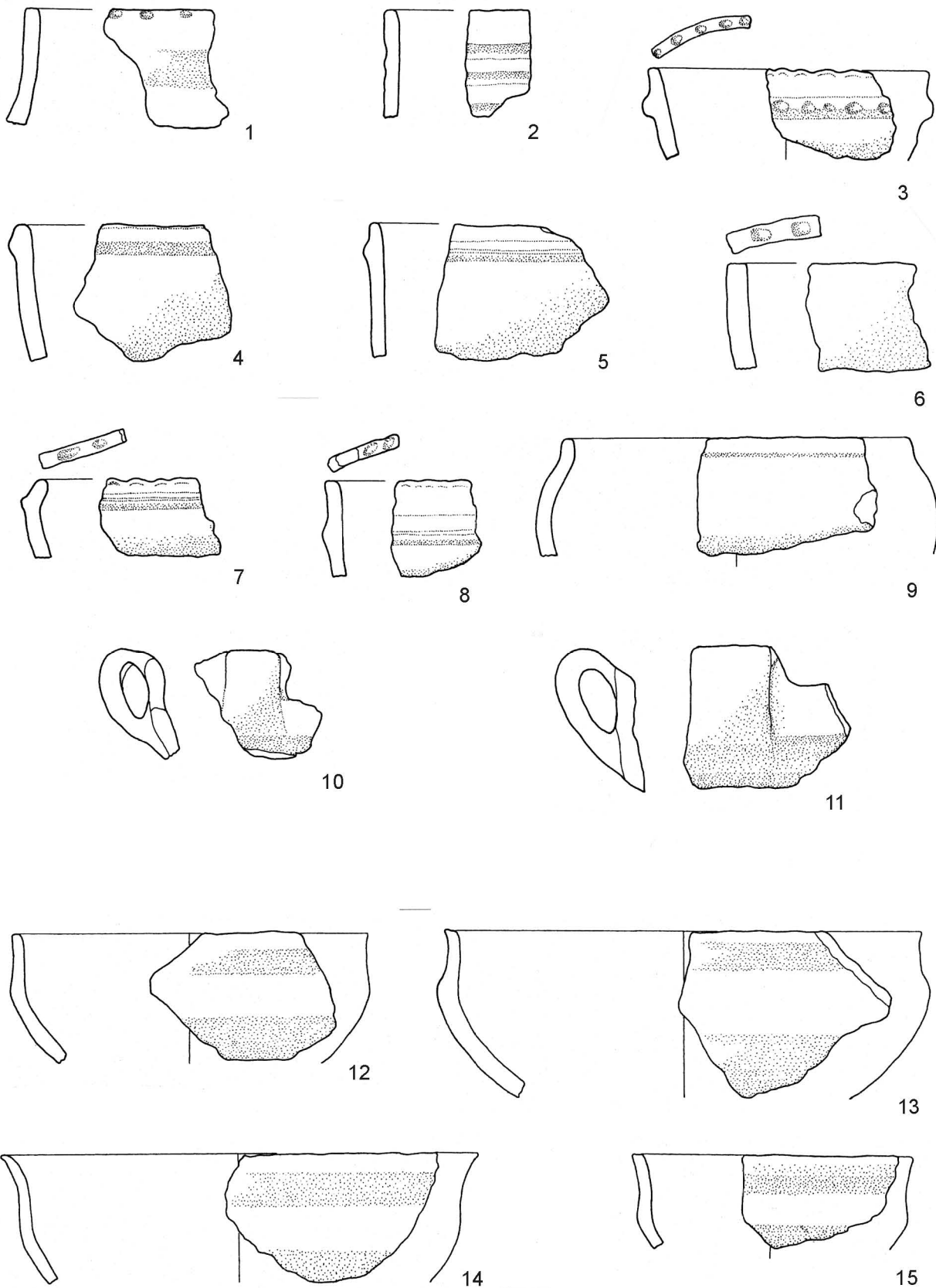

Tav. 79 - Santa Rosa di Poviglio: materiali ceramici provenienti dall'unità US 1049; 1-11) BV-BR 173-178; 12-15) BV-BQ 175-179 (scala 1:3).

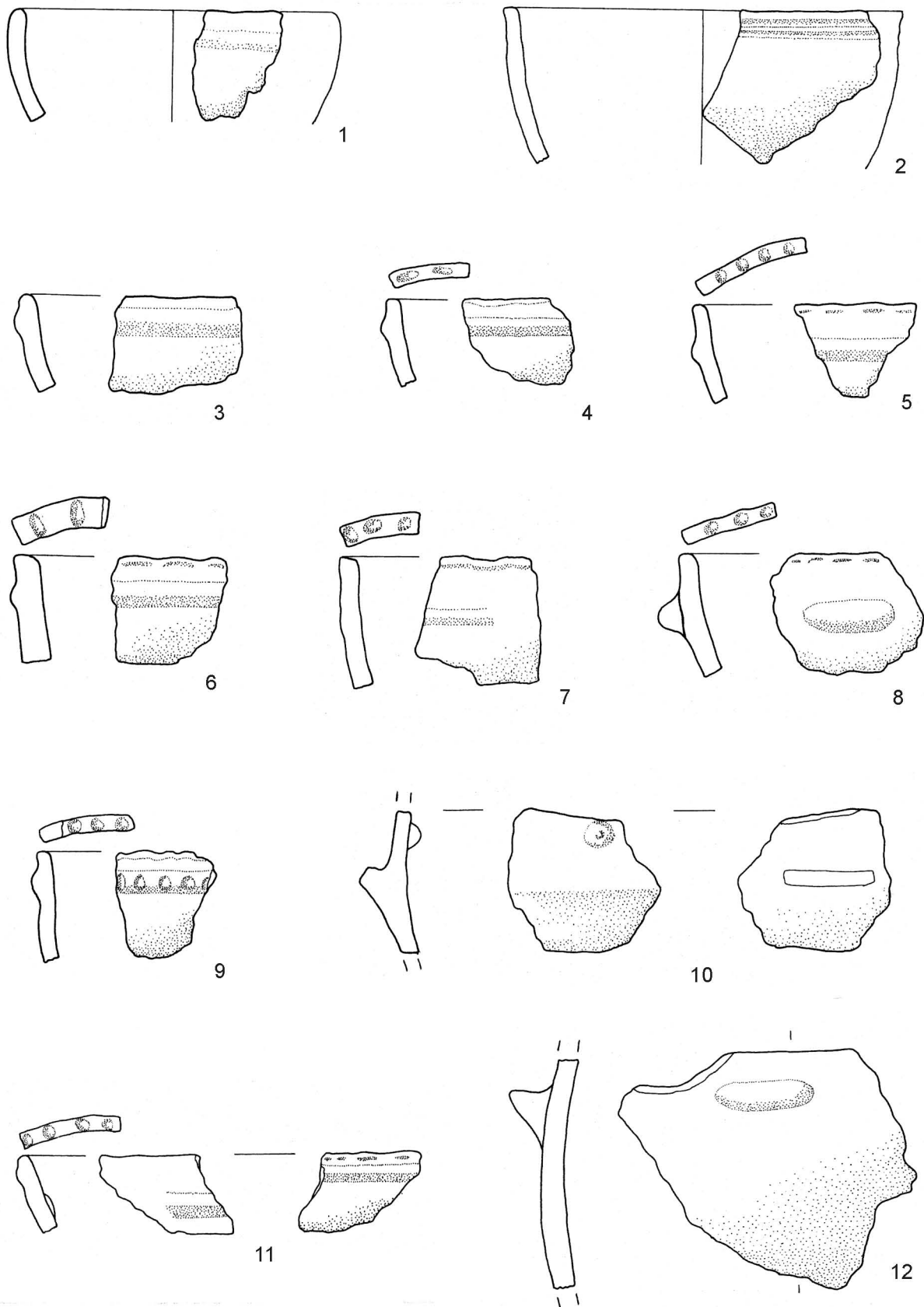

Tav. 80 - Santa Rosa di Poviglio: materiali ceramici provenienti dall'unità US 1049; 1-12) BV-BQ 175-179 (scala 1:3).

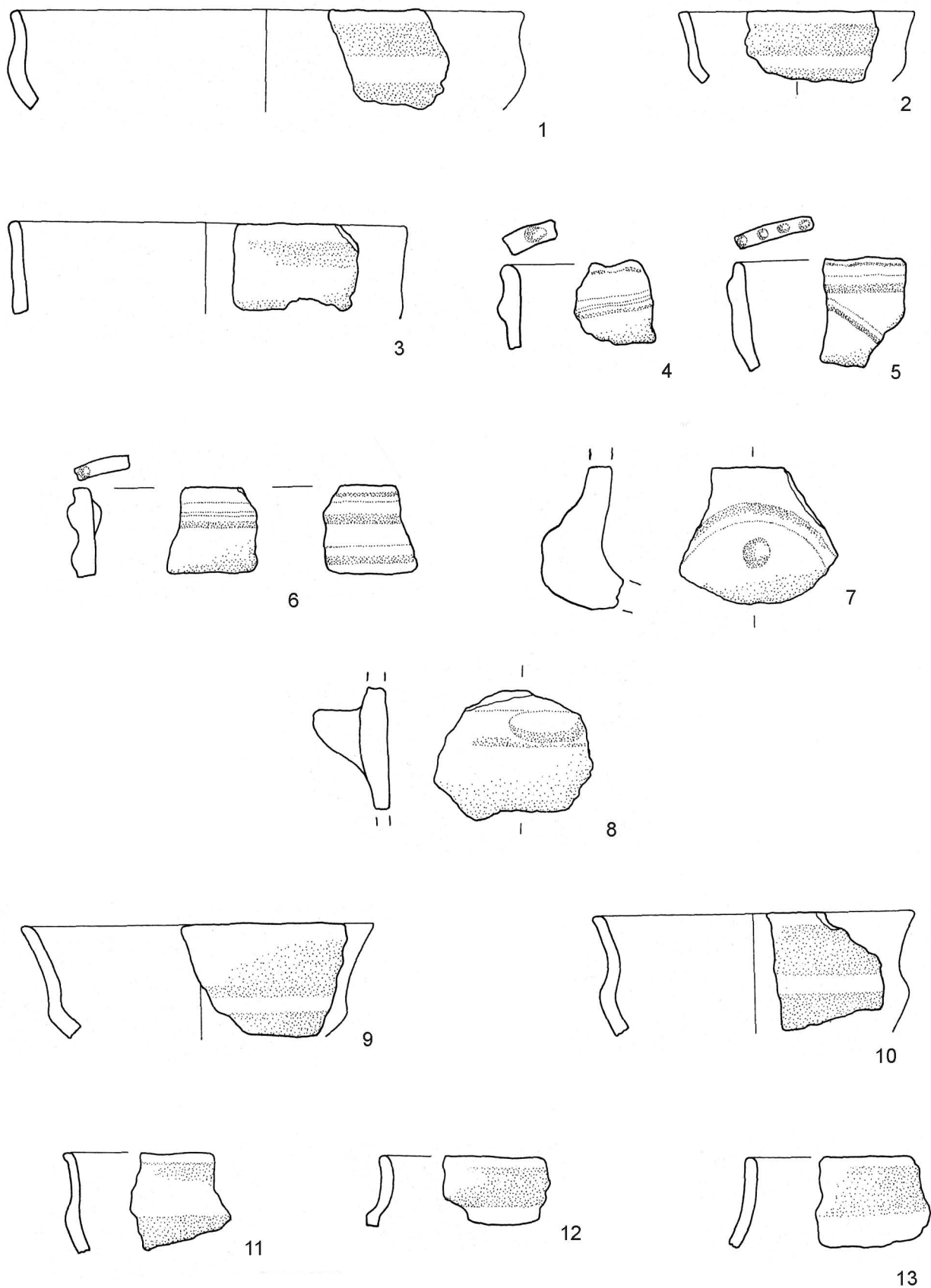

Tav. 81 - Santa Rosa di Poviglio: materiali ceramici provenienti dall'unità US 1049; 1-8) BV-BP 172-173; 9-13) BV-BH 171-181 (scala 1:3).

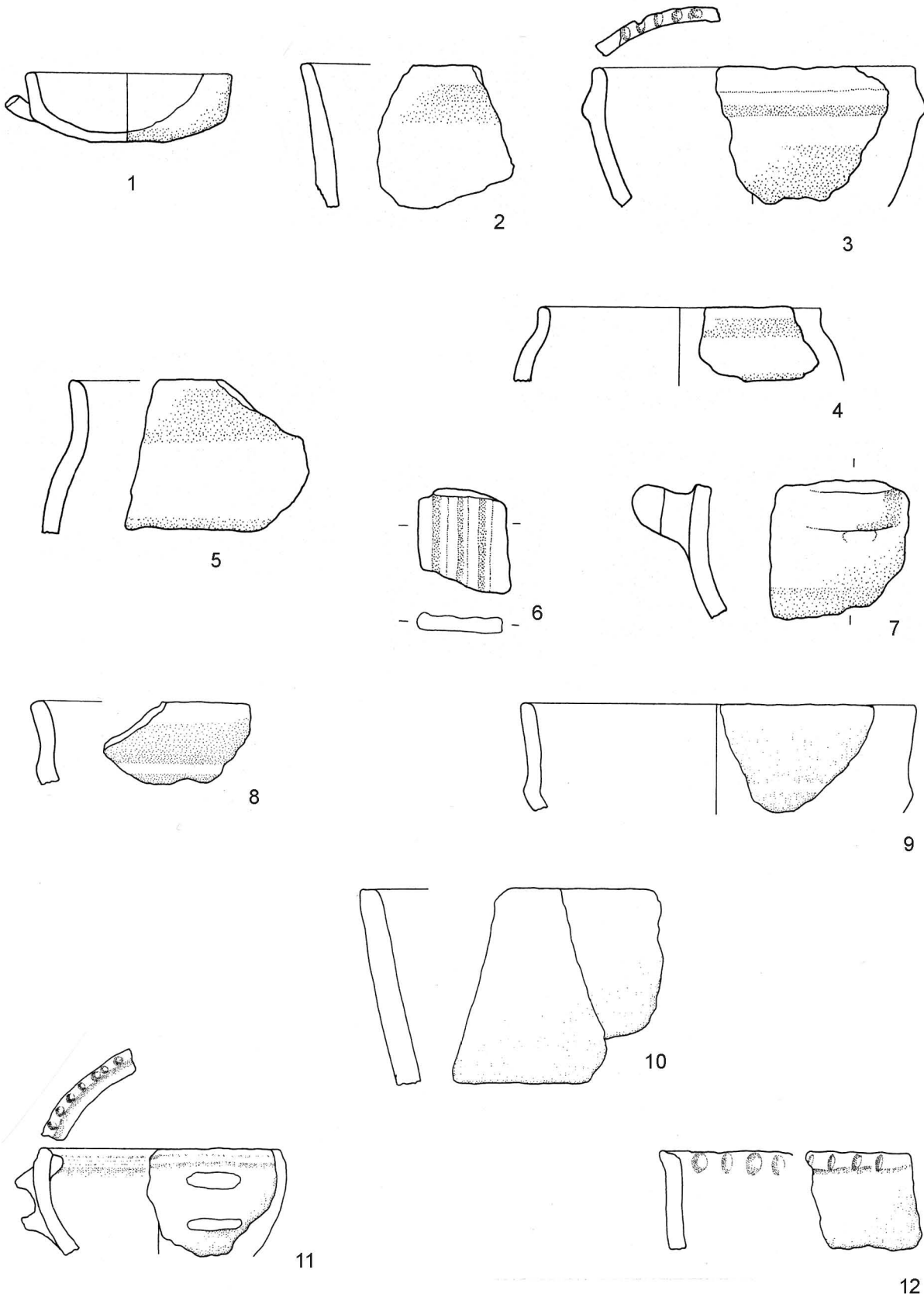

Tav. 82 - Santa Rosa di Poviglio: materiali ceramici provenienti dall'unità US 1049; 1-7) BV-BH 171-181; 8-12) BU 177-183 (scala 1:3).

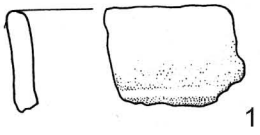

1

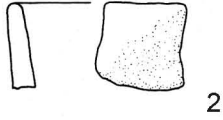

2

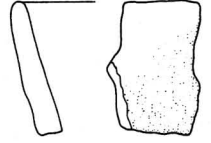

3

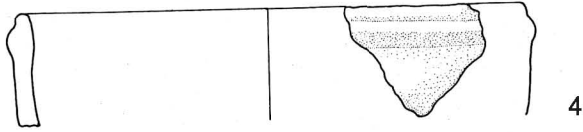

4

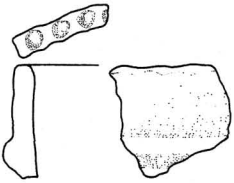

5

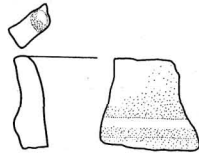

6

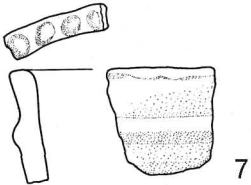

7

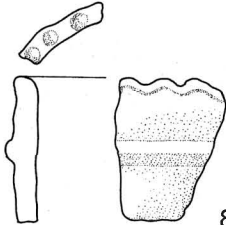

8

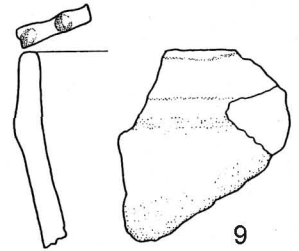

9

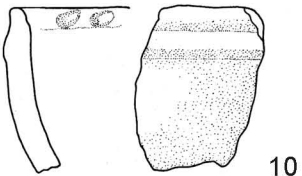

10

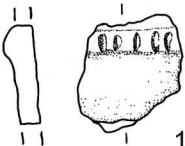

12

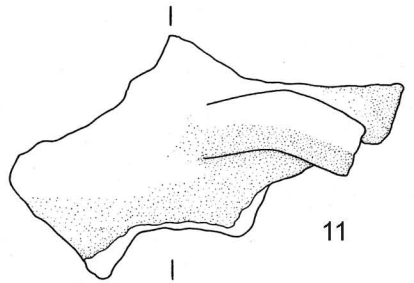
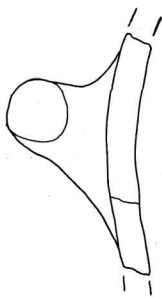

11

Tav. 83 - Santa Rosa di Poviglio: materiali ceramici provenienti dall'unità US 1049; 1-12) BR-BQ 177-178 (scala 1:3).

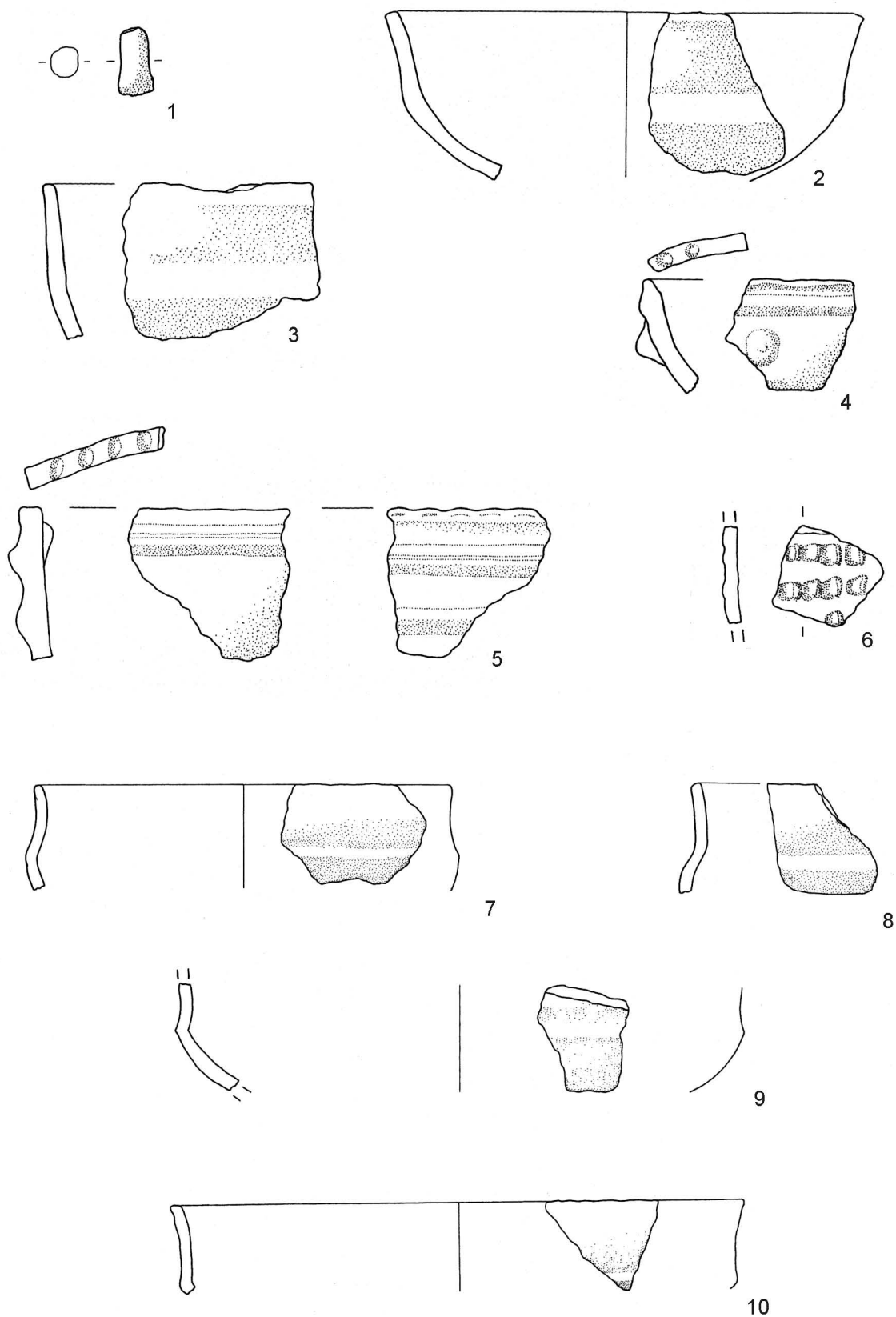

Tav. 84 - Santa Rosa di Poviglio: materiali ceramici provenienti dall'unità US 1049; 1-6) BQ-BN 172-174; 7-10) BP-BL 175-179 (scala 1:3).

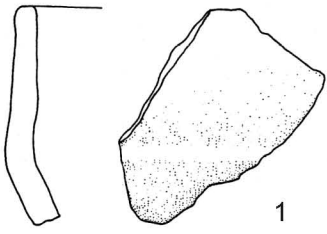

1

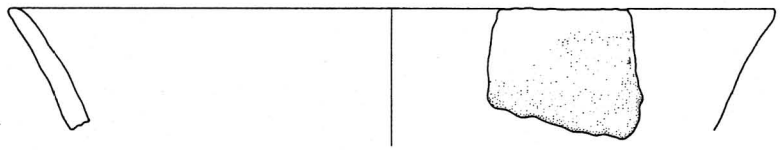

2

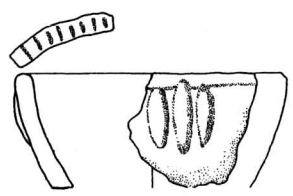

3

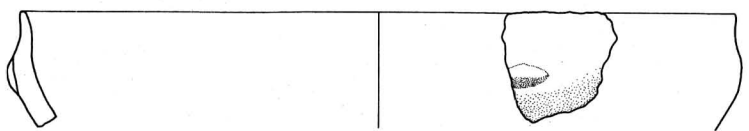

4

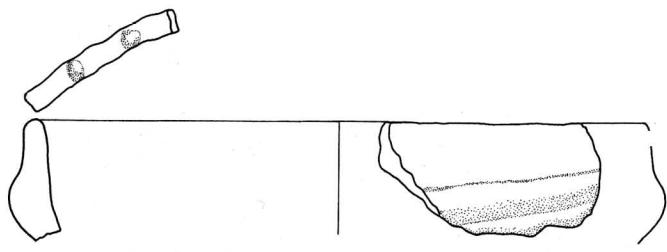

5

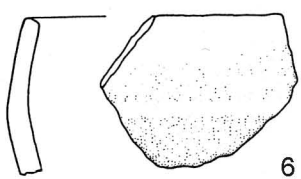

6



7

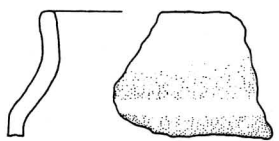

8

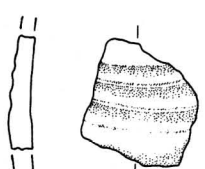

9

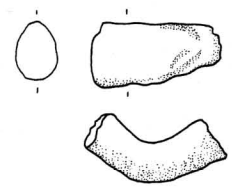

10

Tav. 85 - Santa Rosa di Poviglio: materiali ceramici provenienti dall'unità US 1049; 1-10) BP-BL 175-179 (scala 1:3).

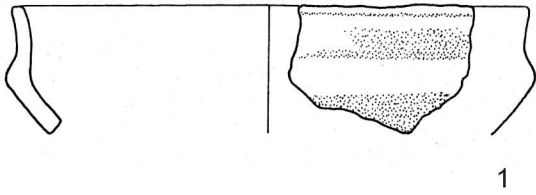

1

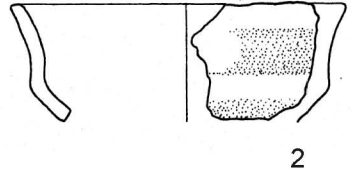

2

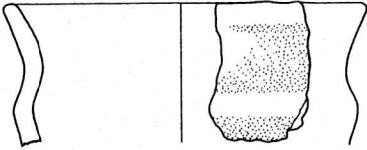

3

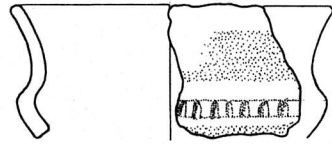

4

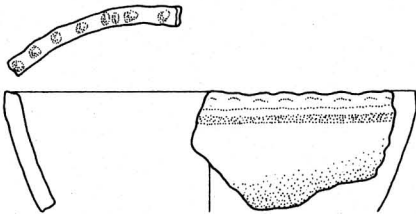

5

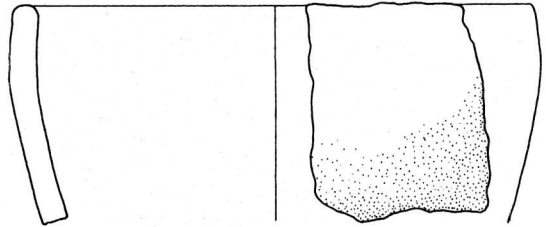

6

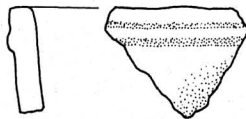

7

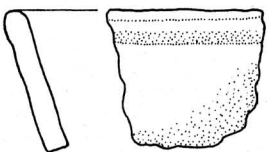

8

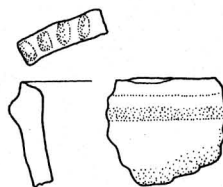

9

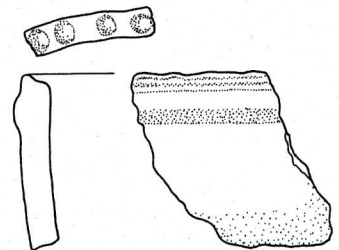

10

Tav. 86 - Santa Rosa di Poviglio: materiali ceramici provenienti dall'unità US 1049; 1-10) BO-BL 172-174 (scala 1:3).

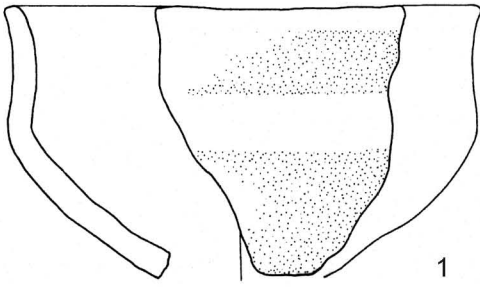

1

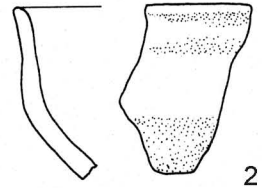

2

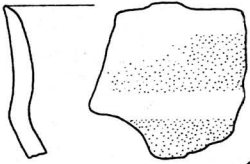

3

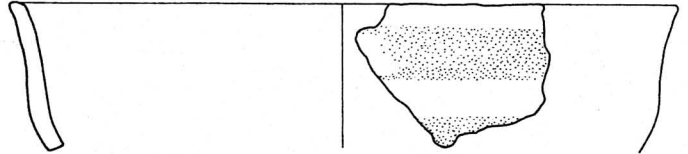

4

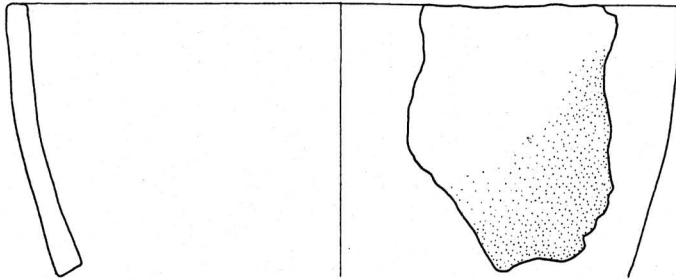

5

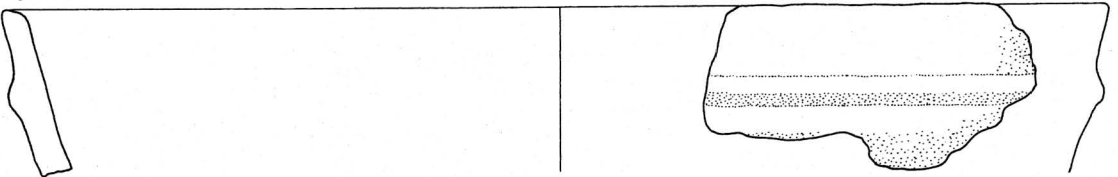
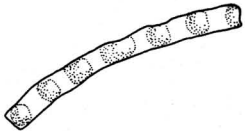

6

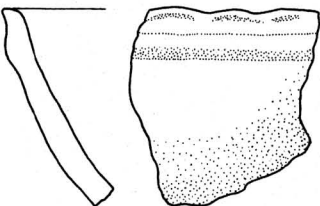

7

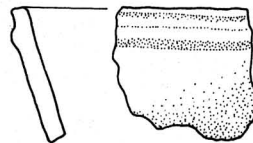
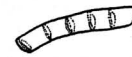

8

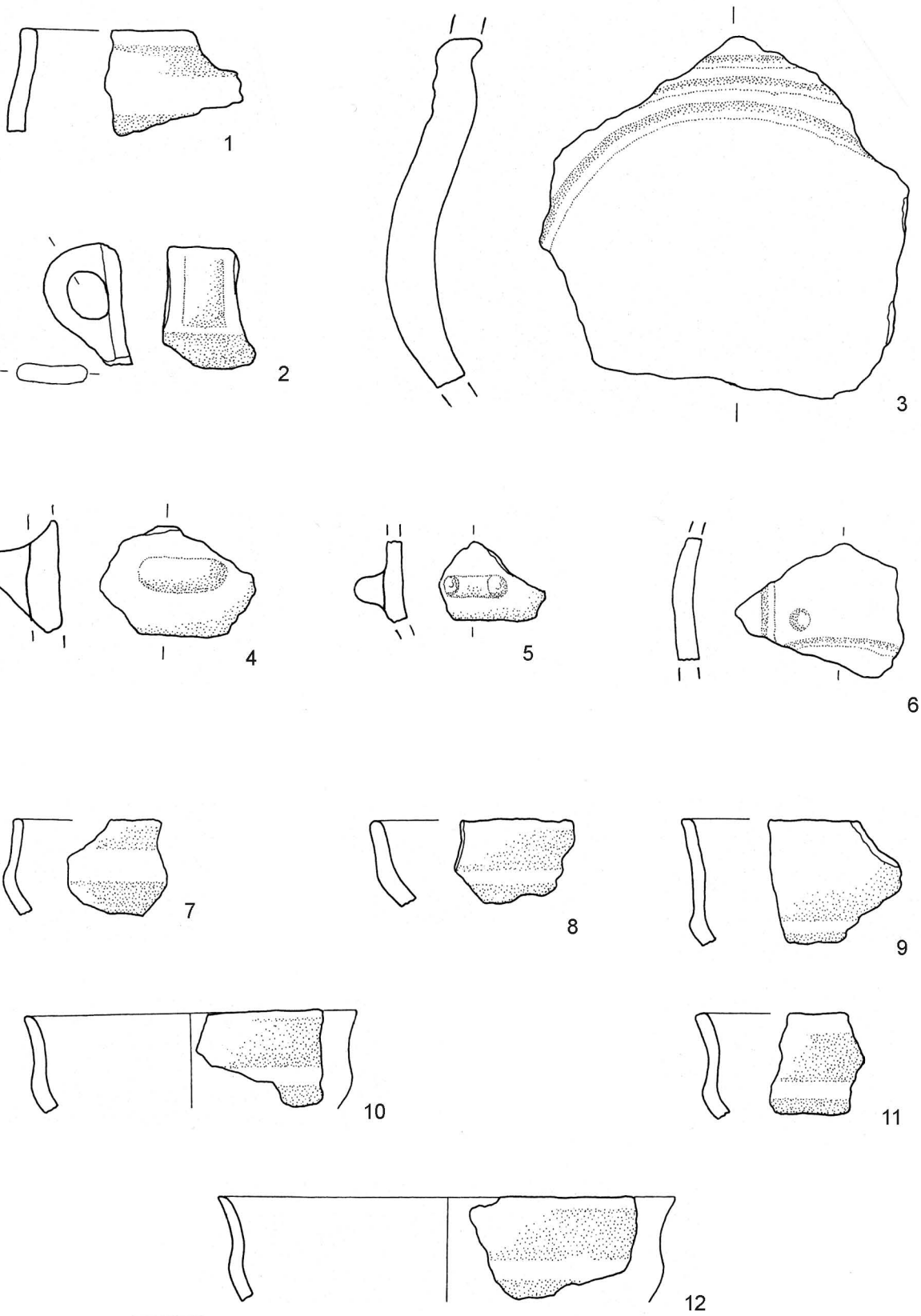

Tav. 88 - Santa Rosa di Poviglio: materiali ceramici provenienti dall'unità US 1049; 1-6) BM-BH 174-176; 7-12) BM-BF 168-170 (scala 1:3).

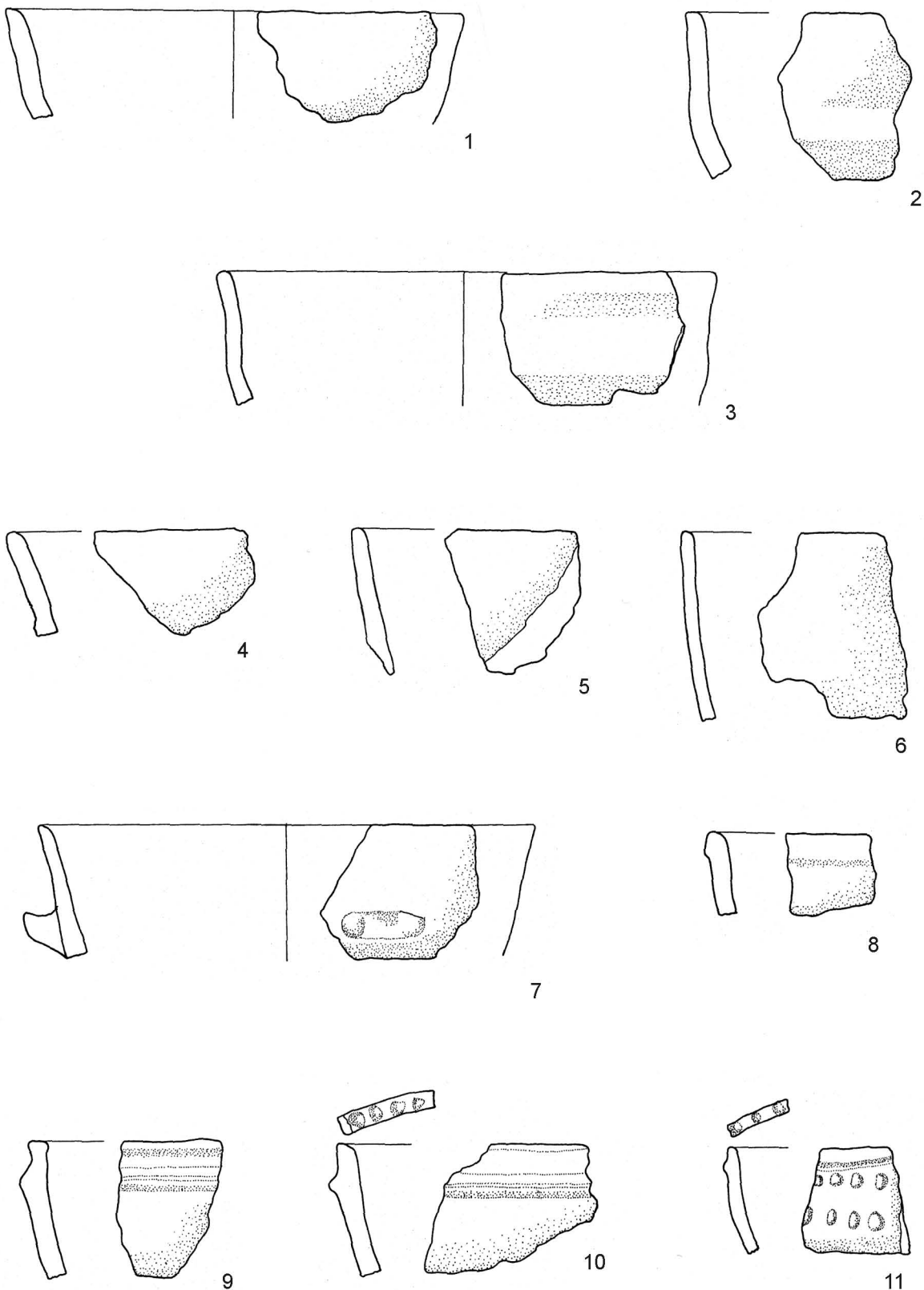

Tav. 89 - Santa Rosa di Poviglio: materiali ceramici provenienti dall'unità US 1049; 1-11) BM-BF 168-170 (scala 1:3).

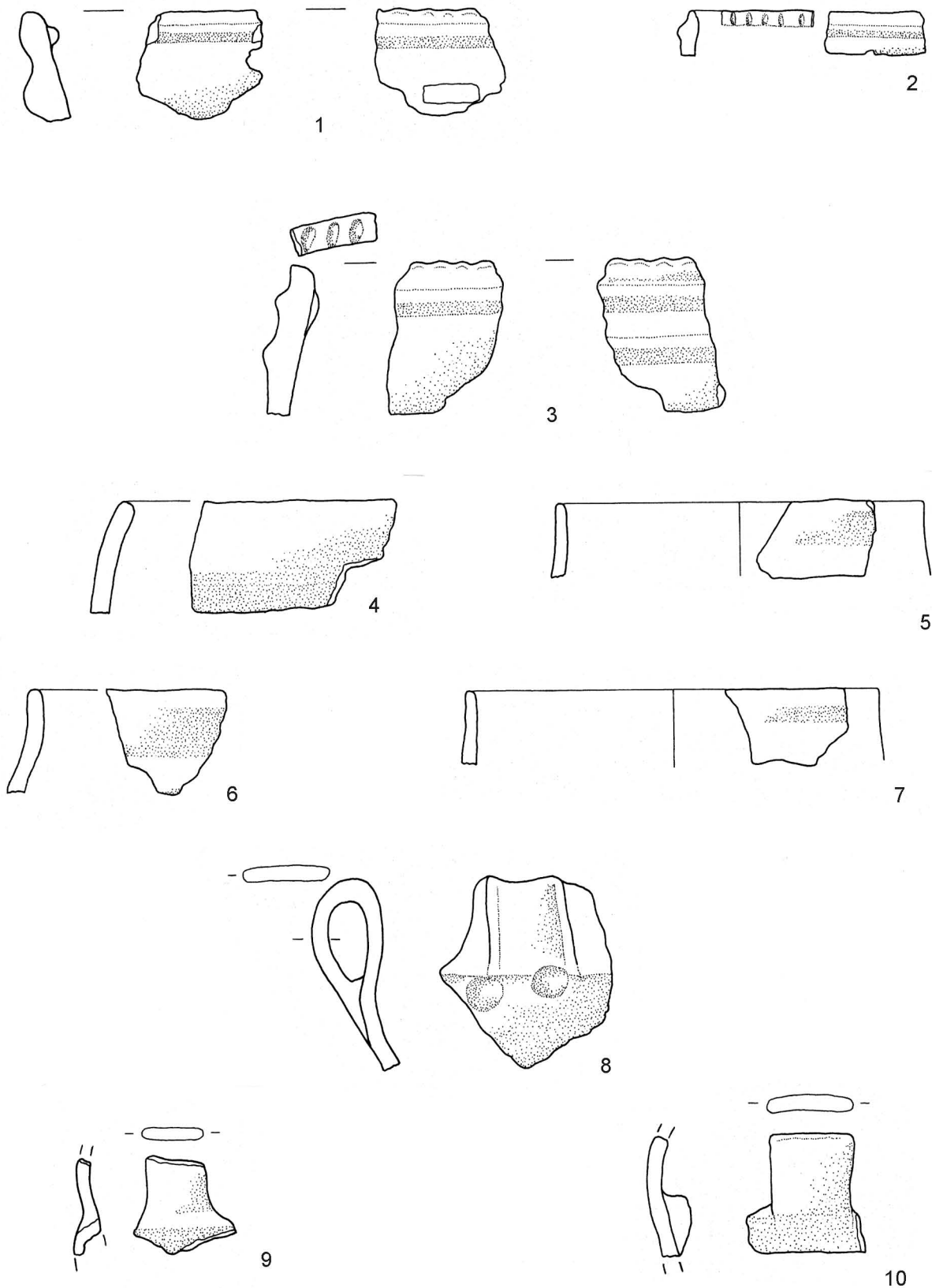

Tav. 90 - Santa Rosa di Poviglio: materiali ceramici provenienti dall'unità US 1049; 1-10) BM-BF 168-170 (scala 1:3).

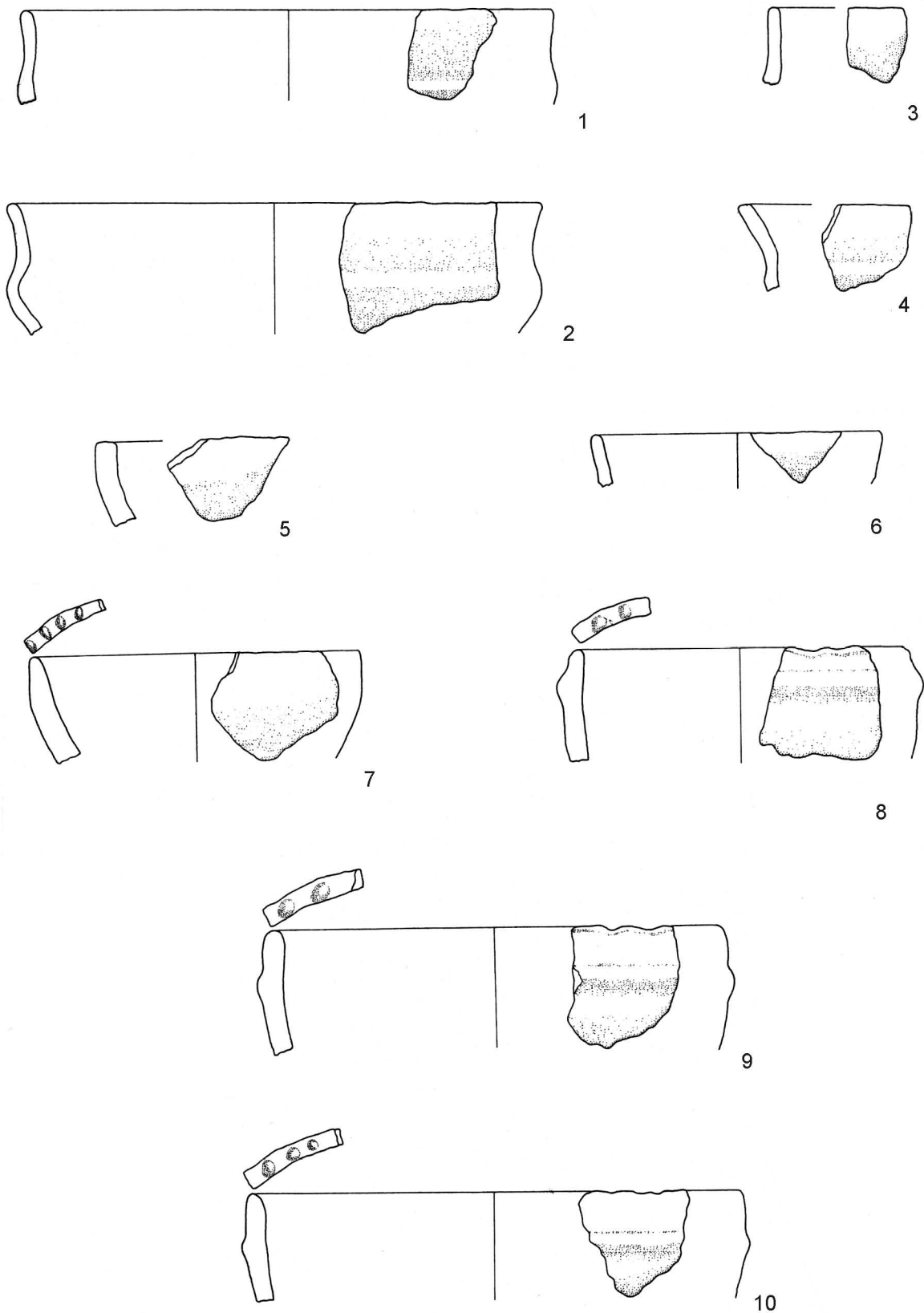

Tav. 91 - Santa Rosa di Poviglio: materiali ceramici provenienti dall'unità US 1049; 1-10) BG-BF 174-179 (scala 1:3).

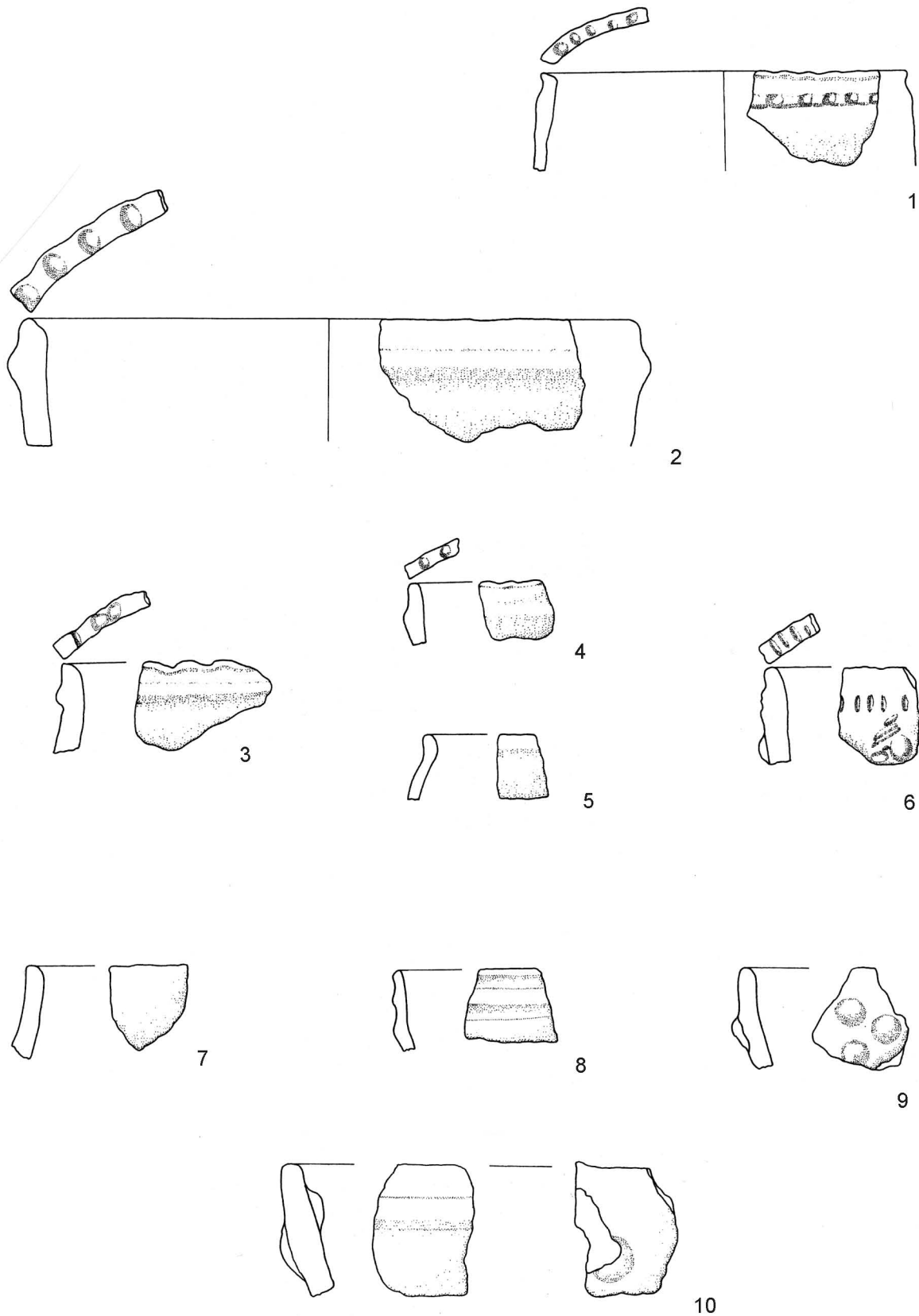

Tav. 92 - Santa Rosa di Poviglio: materiali ceramici provenienti dall'unità US 1049; 1-6) BG-BF 174-179; 7-10) BE-BD 174-177 (scala 1:3).

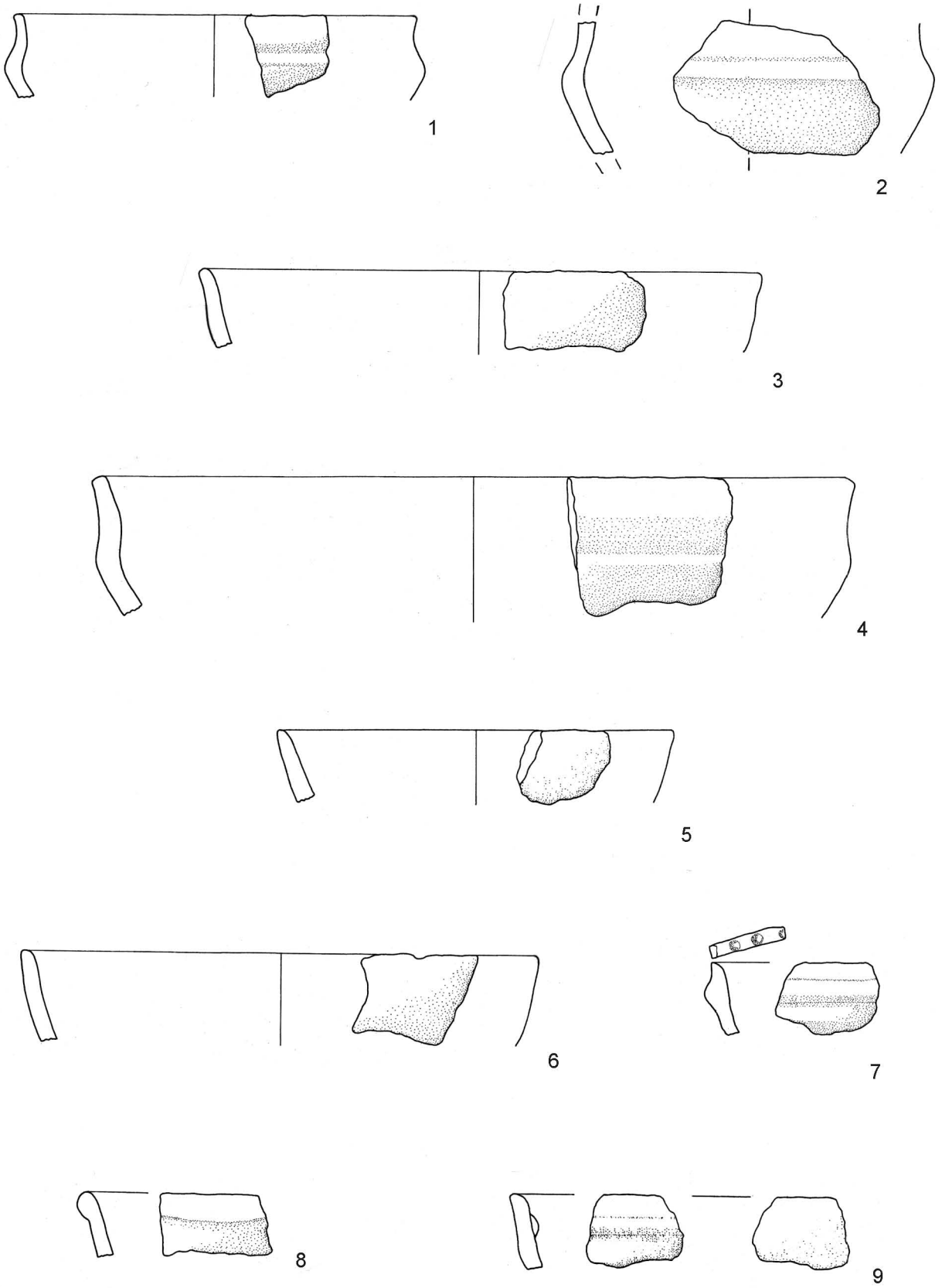

Tav. 93 - Santa Rosa di Poviglio: materiali ceramici provenienti dall'unità US 1049; 1-9) BF-Z 174-178 (scala 1:3).

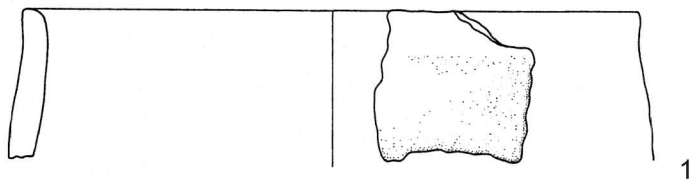

1

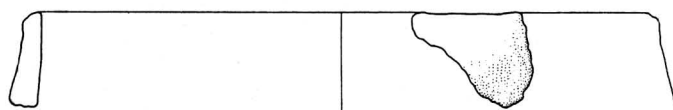

2

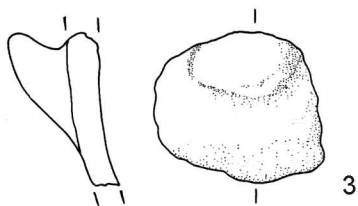

3

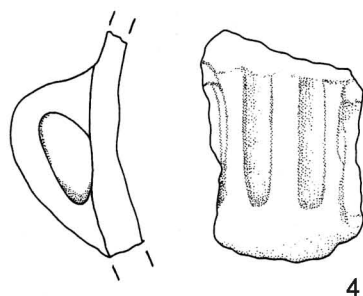

4

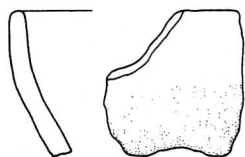

5

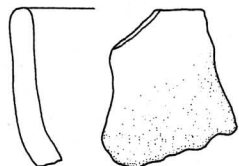

6

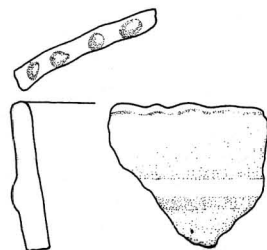

8

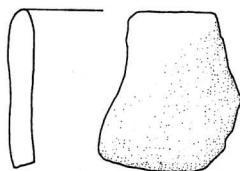

7

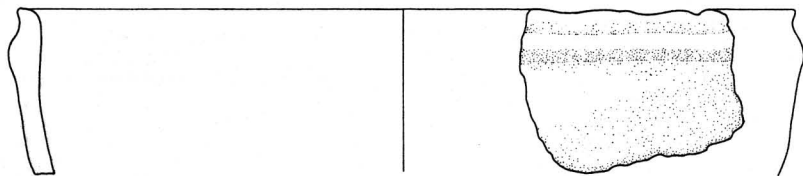
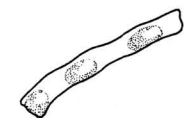

9

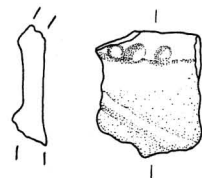

10

Tav. 94 - Santa Rosa di Poviglio: materiali ceramici provenienti dall'unità US 1049; 1-4) BF-Z 174-178; 5-10) Z 167-174 (scala 1:3).

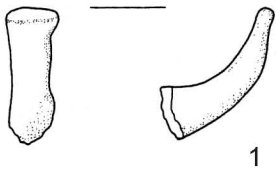

1

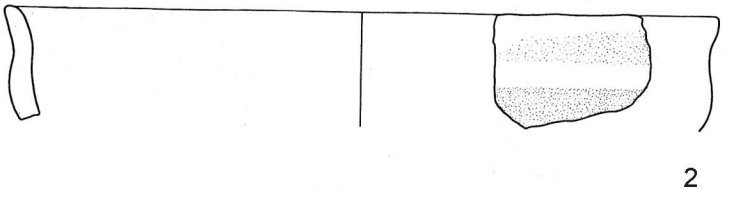

2

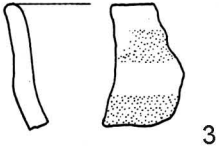

3

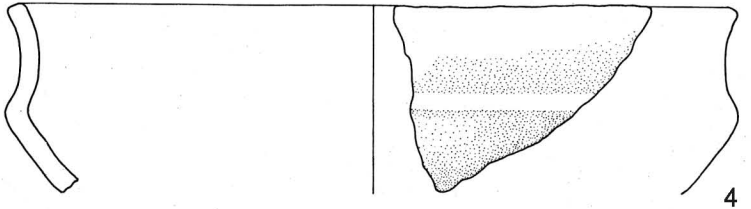

4

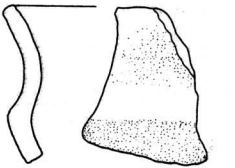

5

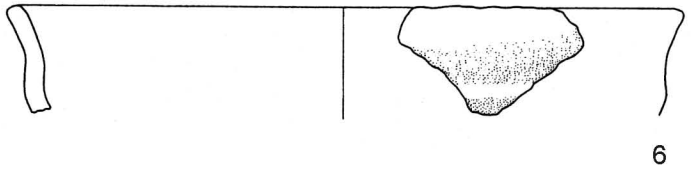

6

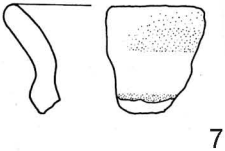

7

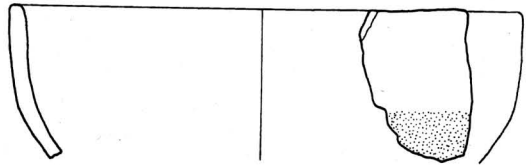

8

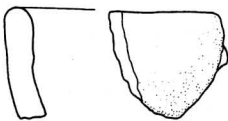

9

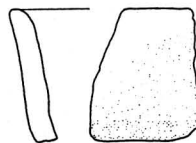

10

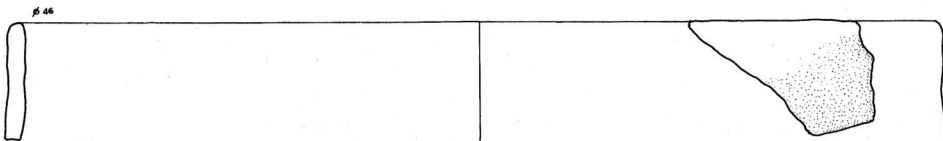

11

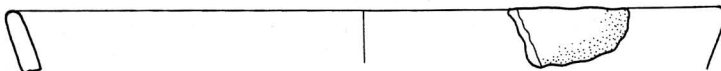

12

Tav. 95 - Santa Rosa di Poviglio: materiali ceramici provenienti dall'unità US 1049; 1-12) BA-Z 174-178 (scala 1:3).

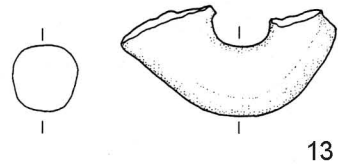
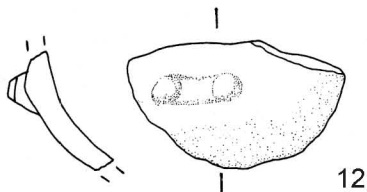
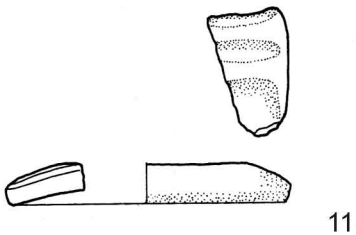
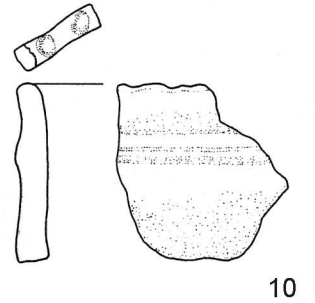
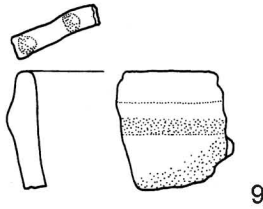
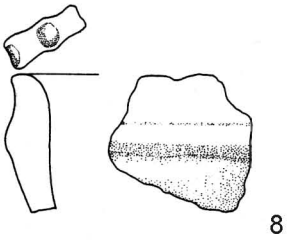
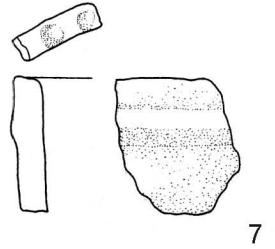
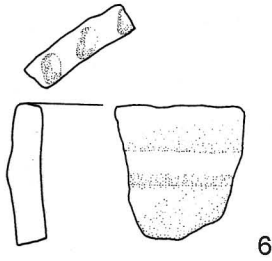
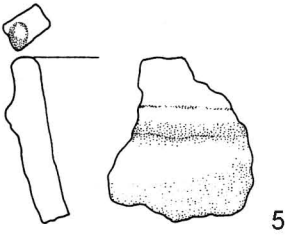
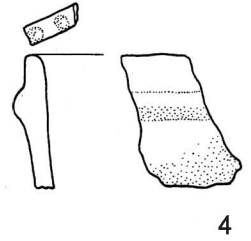
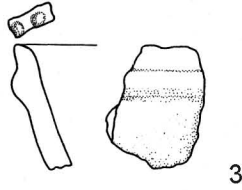
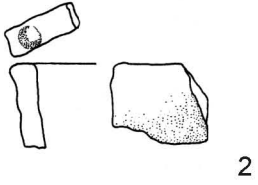
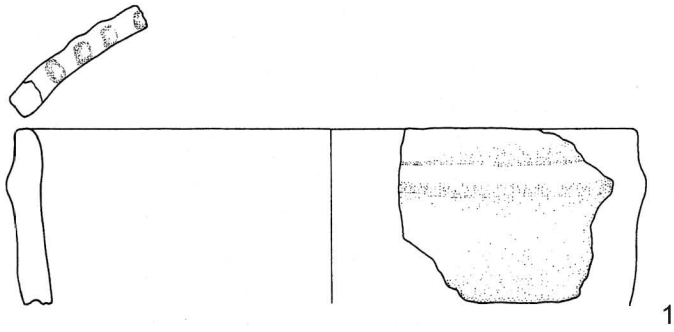

Tav. 96 - Santa Rosa di Poviglio: materiali ceramici provenienti dall'unità US 1049; 1-13) BA-Z 174-178 (scala 1:3).

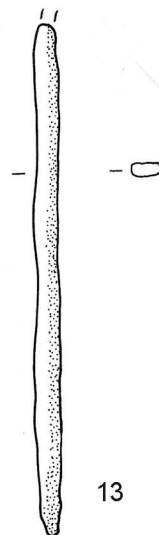
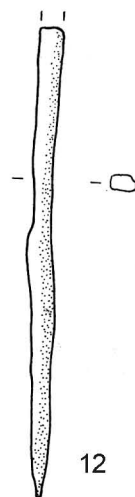
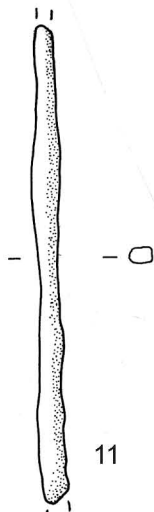
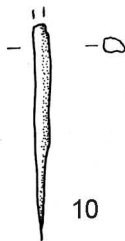
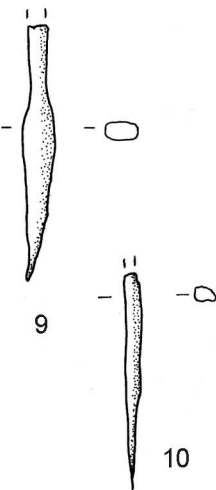
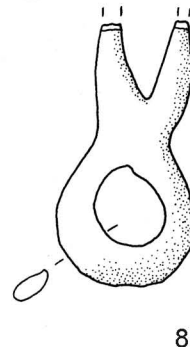
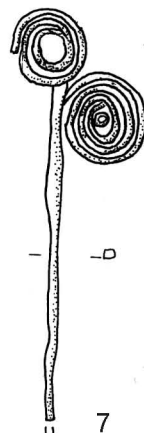
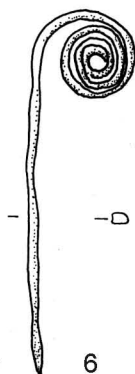
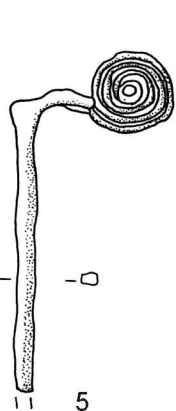
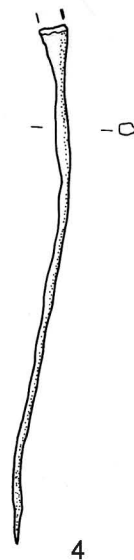
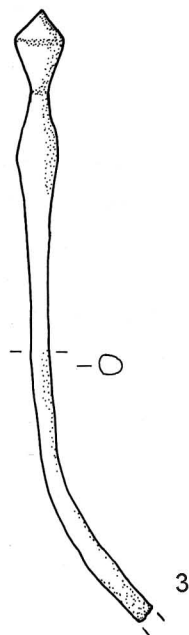
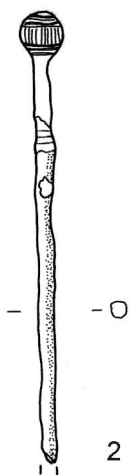
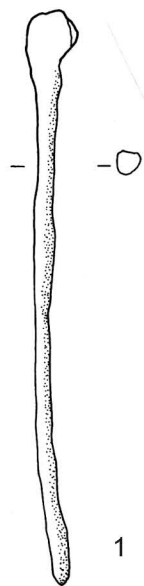

Tav. 97 - Santa Rosa di Poviglio: materiali in bronzo provenienti dall'unità US 1049 (grandezza naturale).

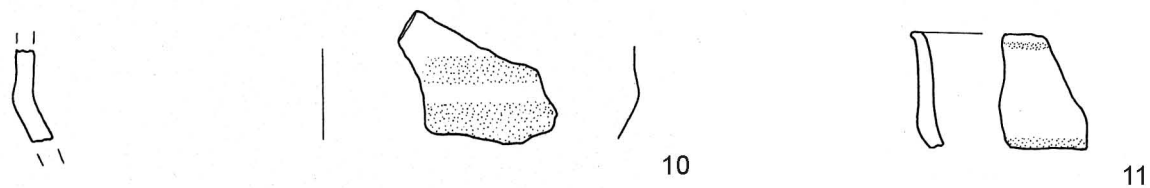
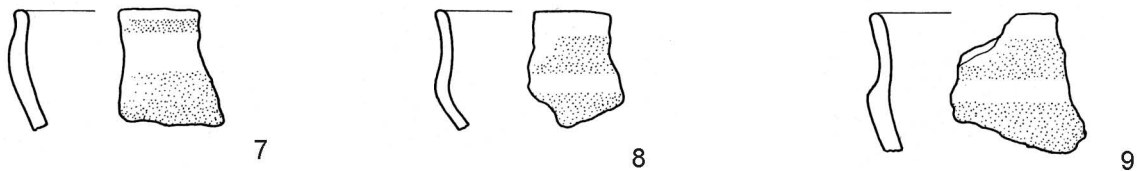
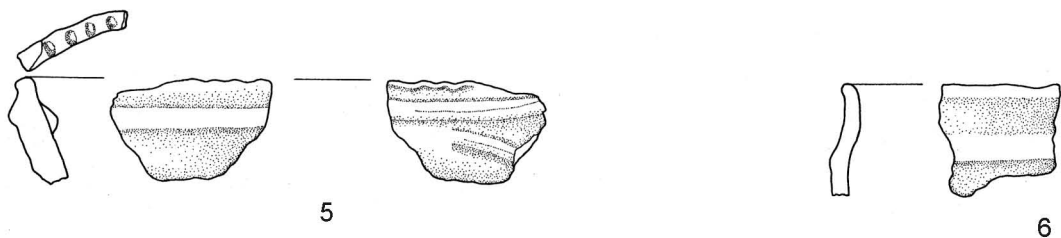
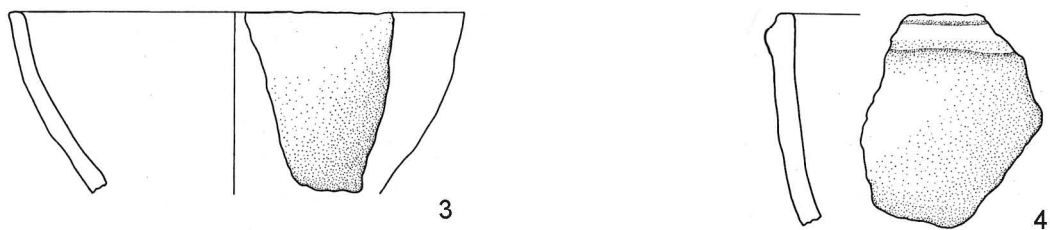
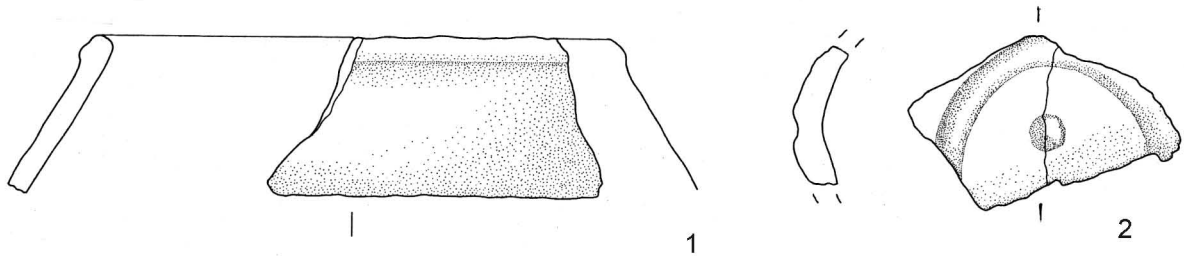

Tav. 98 - Santa Rosa di Poviglio: materiali ceramici provenienti dall'unità US 5175; 1-2) AL-AI 156-157; 3-6) AH-AG 144-146; 7-11) AL-AF 146-150 (scala 1:3).

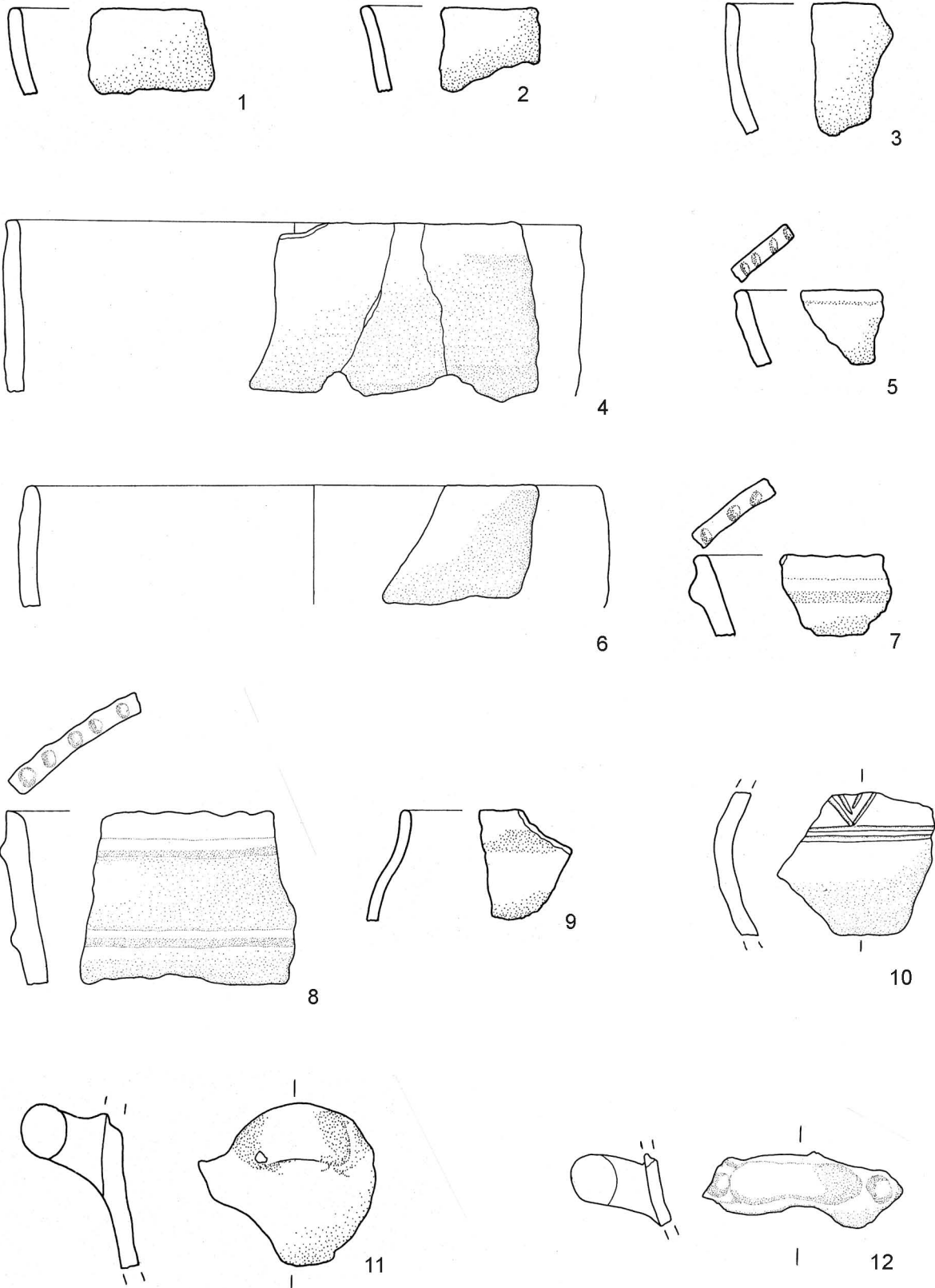

Tav. 99 - Santa Rosa di Poviglio: materiali ceramici provenienti dall'unità US 5175; 1-12) AL-AF 146-150 (scala 1:3).

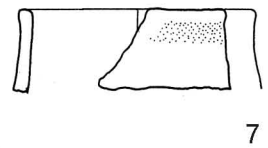
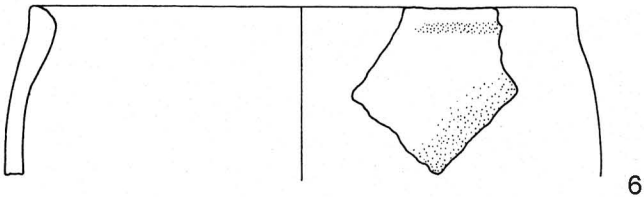
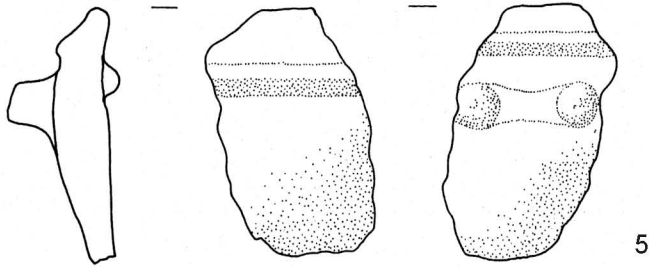
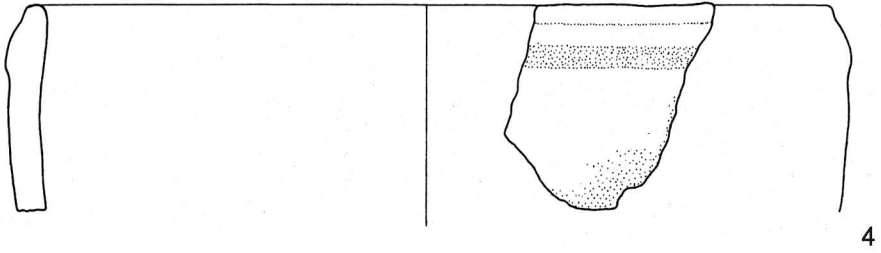
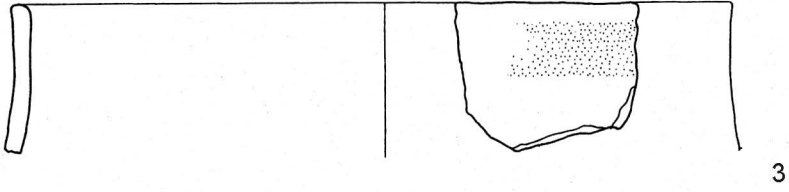
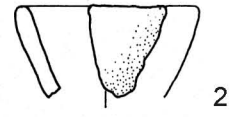
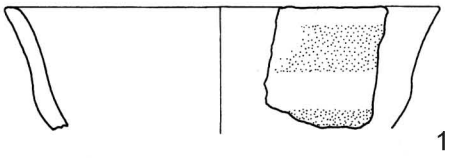

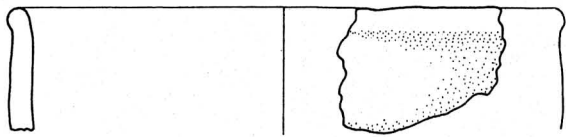

1

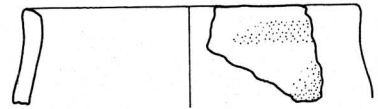

2



3

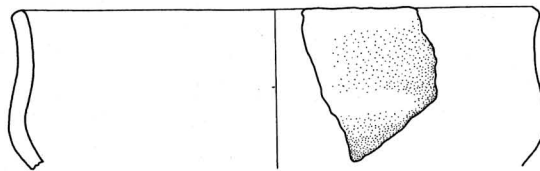

4

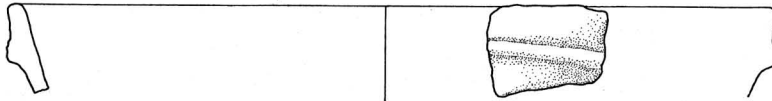

5

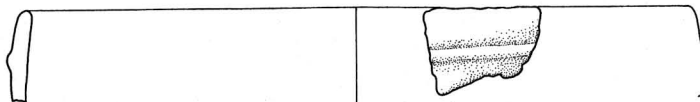

6

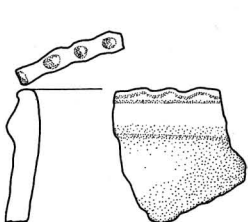

7

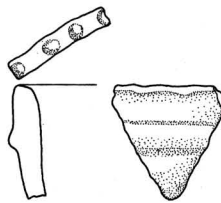

8

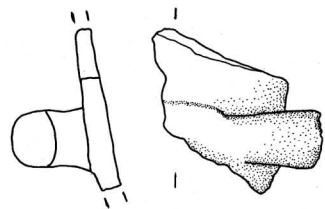

9

Tav. 101 - Santa Rosa di Poviglio: materiali ceramici provenienti dall'unità US 5175; 1-3) AL-AE 140-143; 4-9) AL-AD 145-149 (scala 1:3).

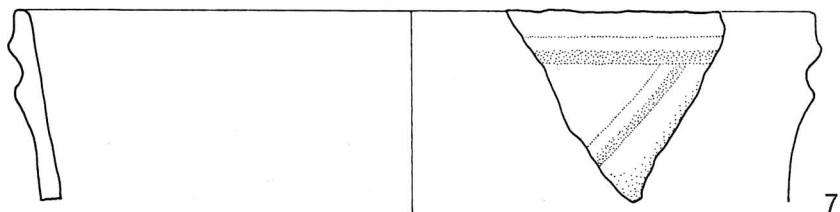
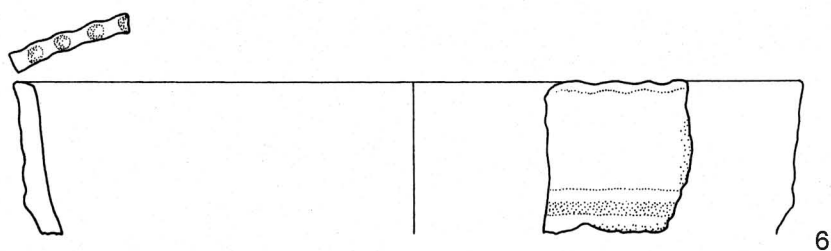
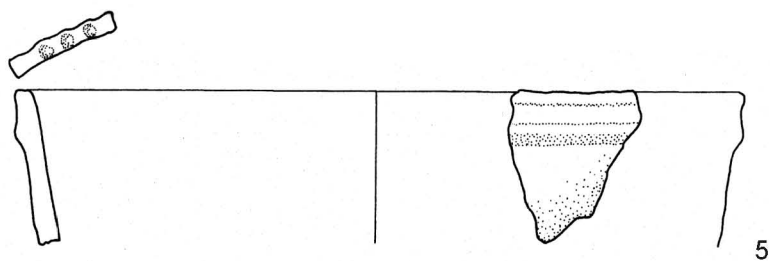
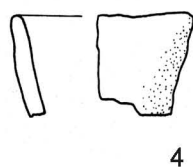
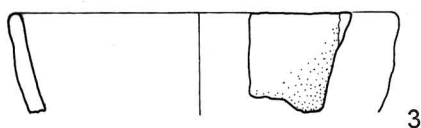
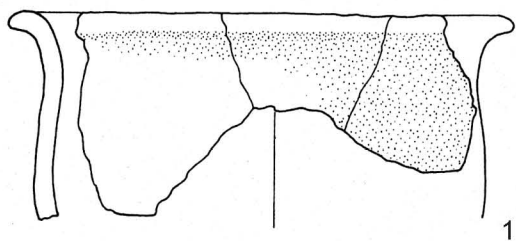

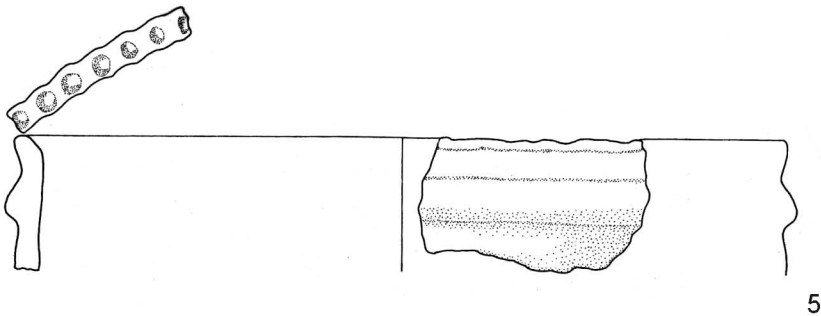
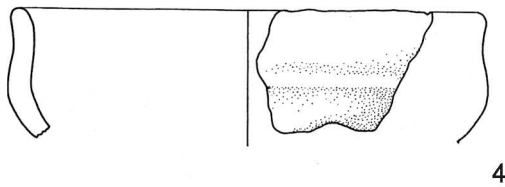
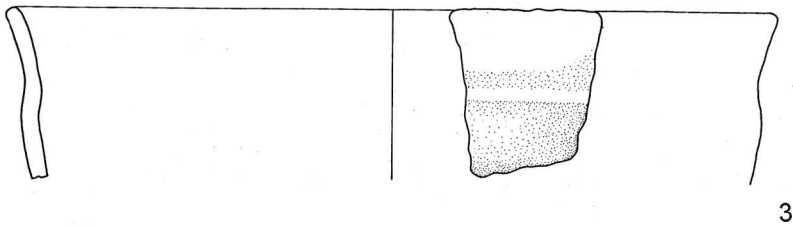
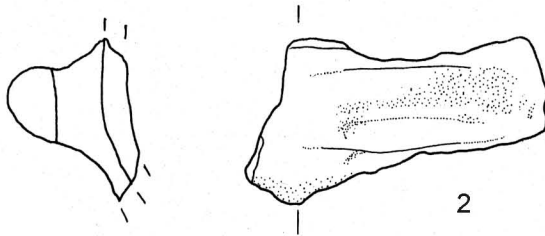
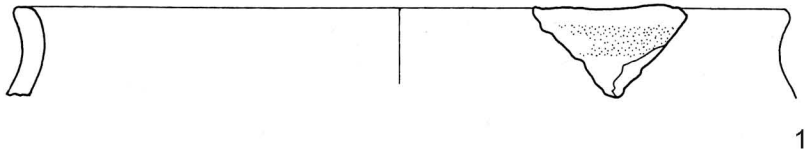

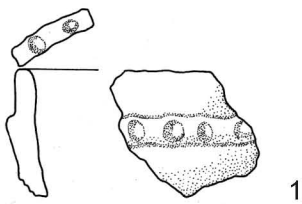

1

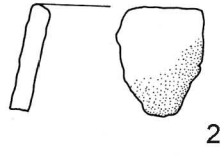

2

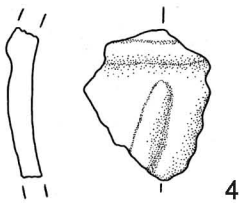

4

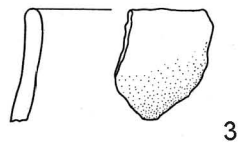

3

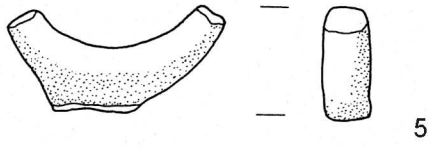

5

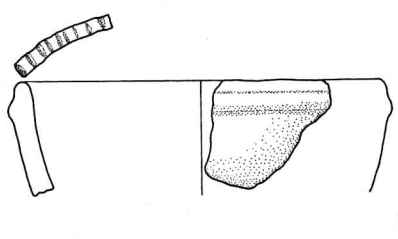

6

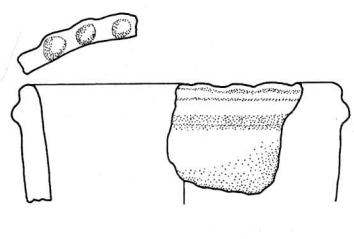

7

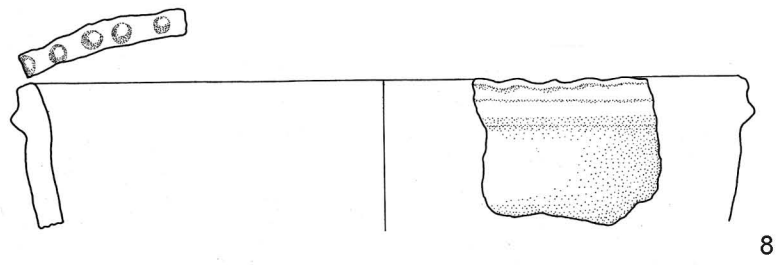

8

Tav. 104 - Santa Rosa di Poviglio: materiali ceramici provenienti dall'unità US 5175; 1-4) AF-AA 147-150; 5-8) AE-AD 145-147 (scala 1:3).

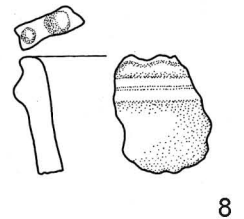
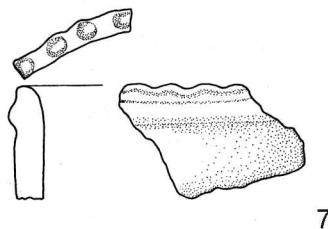
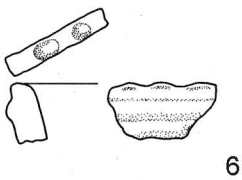
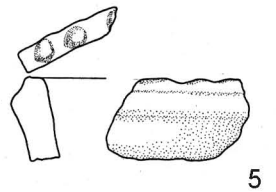
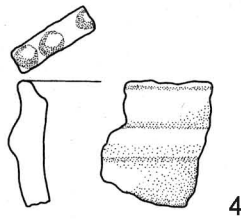
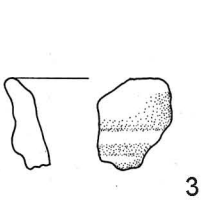
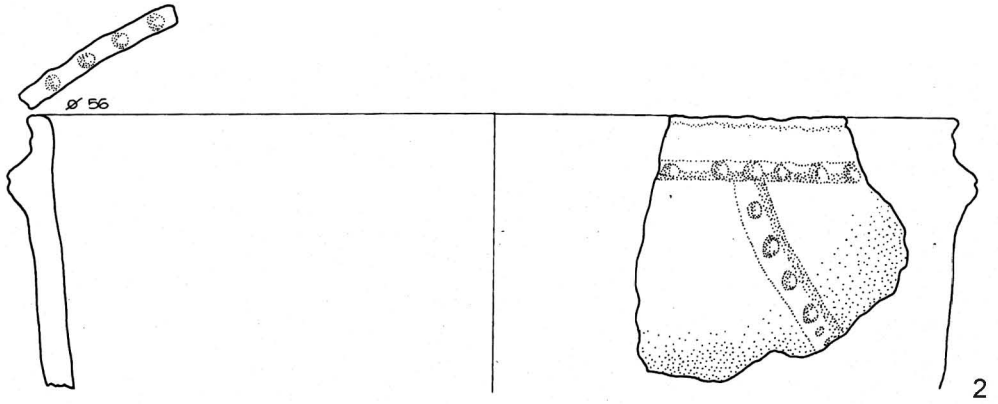
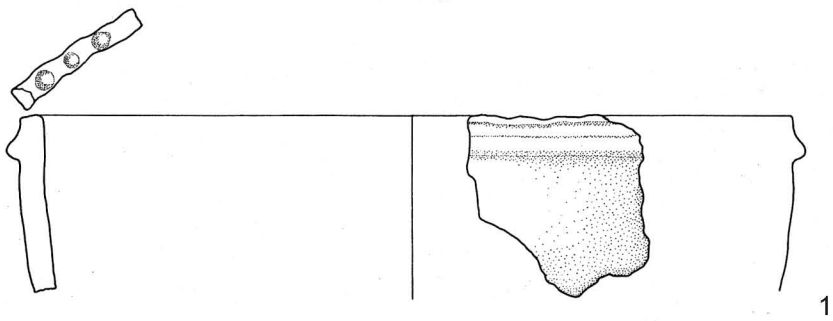

Tav. 105 - Santa Rosa di Poviglio: materiali ceramici provenienti dall'unità US 5175; 1-8) AE-AD 145-147 (scala 1:3).

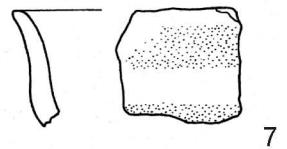
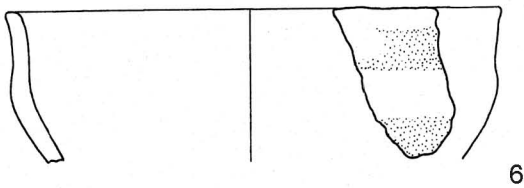
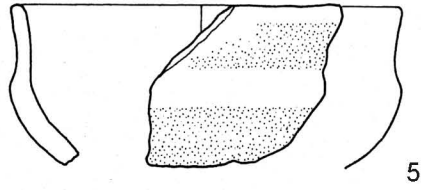
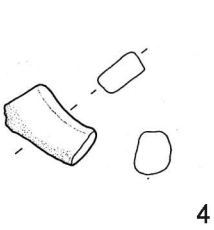
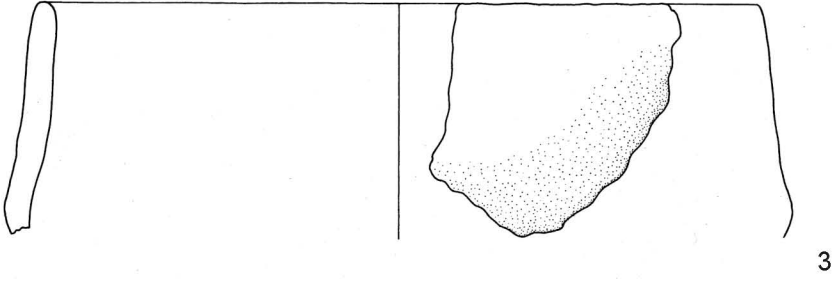
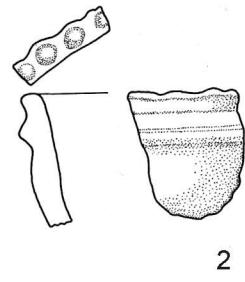
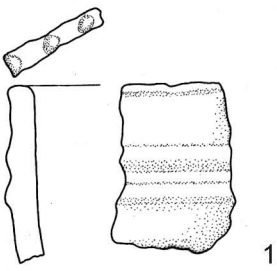

Tav. 106 - Santa Rosa di Poviglio: materiali ceramici provenienti dall'unità US 5175; 1-3) AE-AD 145-147; 4-7) AE-AC 143-150 (scala 1:3).

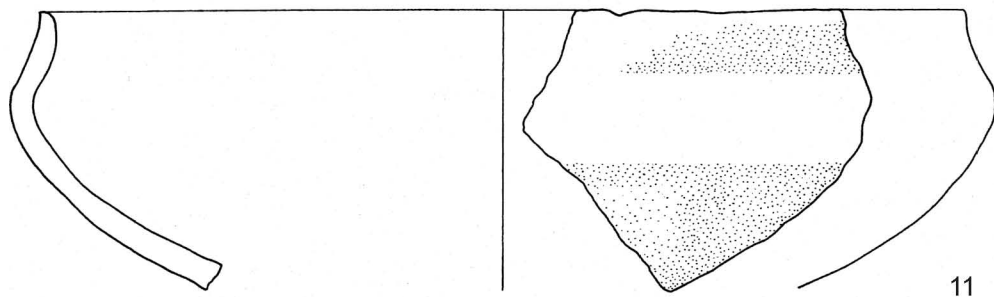
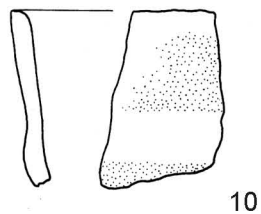
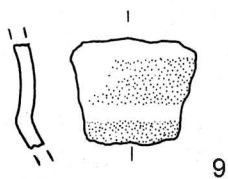
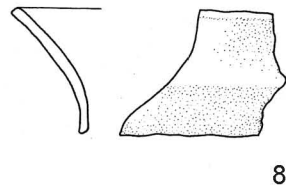
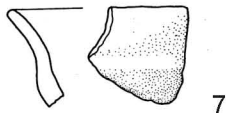
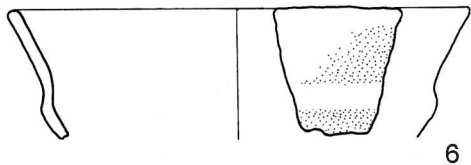
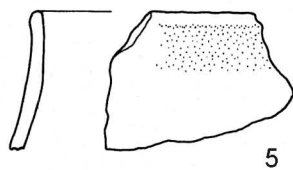
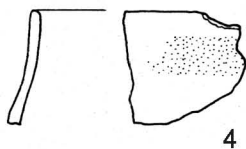
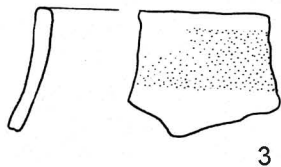
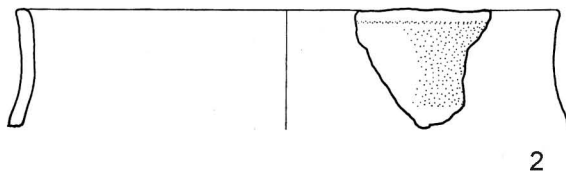
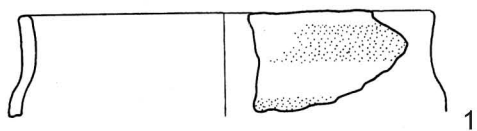

Tav. 107 - Santa Rosa di Poviglio: materiali ceramici provenienti dall'unità US 5175; 1-11) AE-AC 143-150 (scala 1:3).

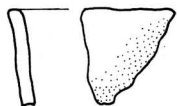

1

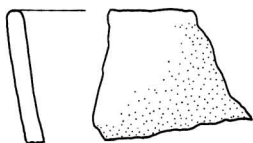

2

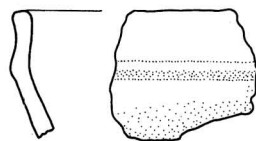

3

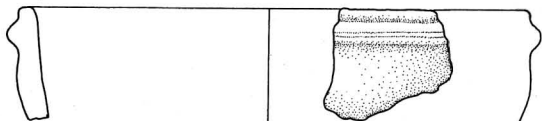

4

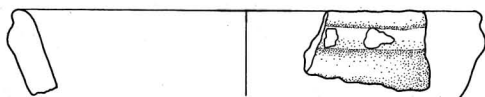

5

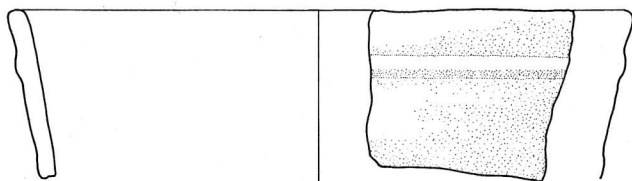

6

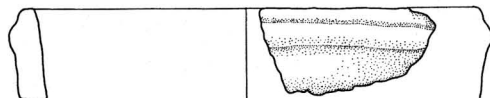

7

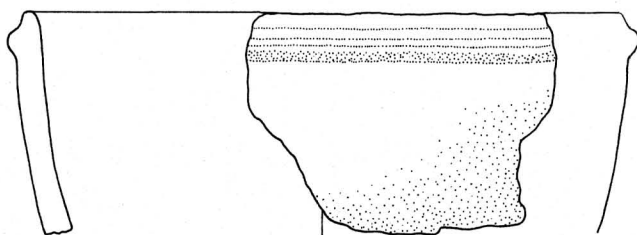

8

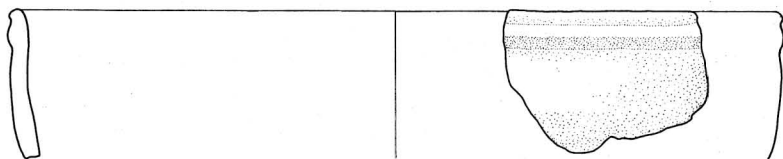

9

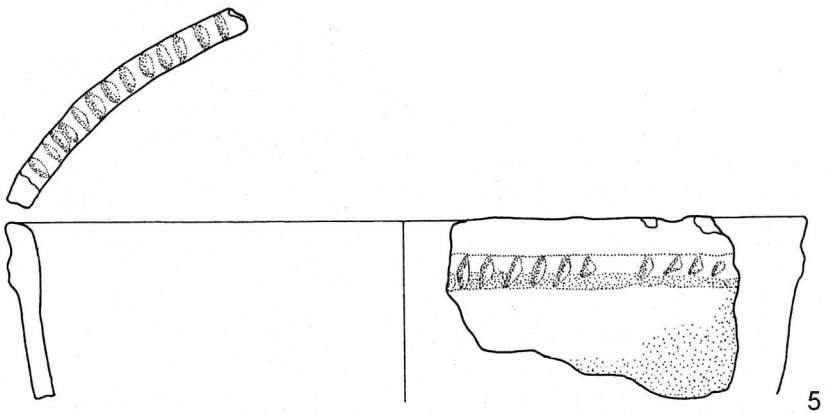
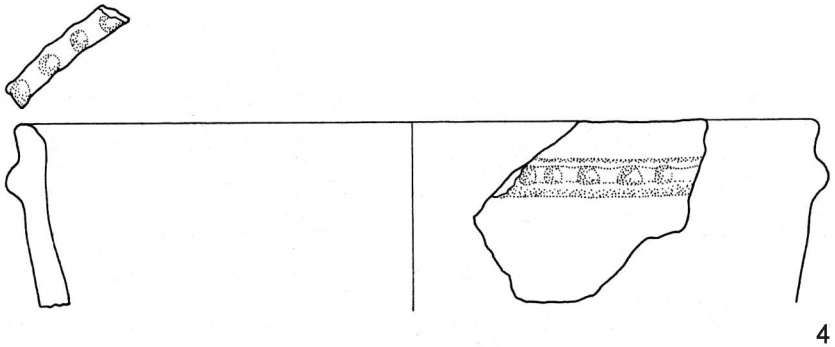
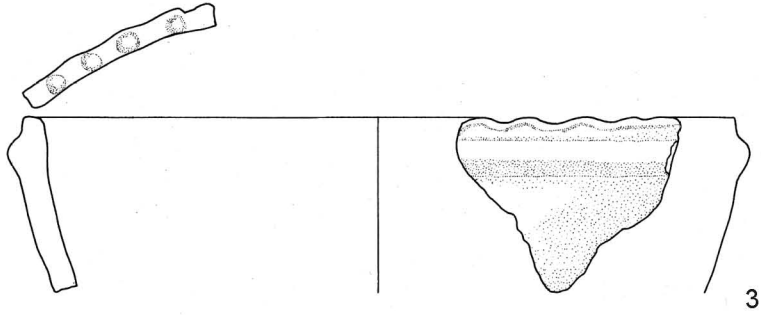
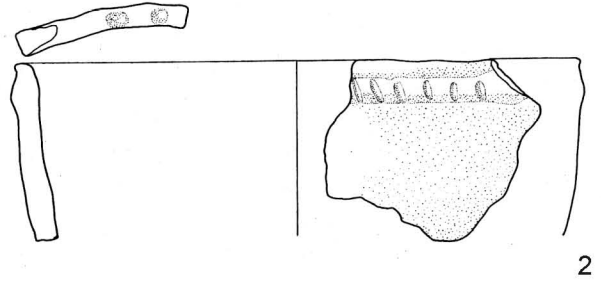
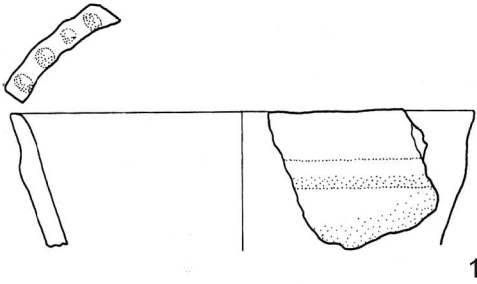

Tav. 109 - Santa Rosa di Poviglio: materiali ceramici provenienti dall'unità US 5175; 1-5) AE-AC 143-150 (scala 1:3).

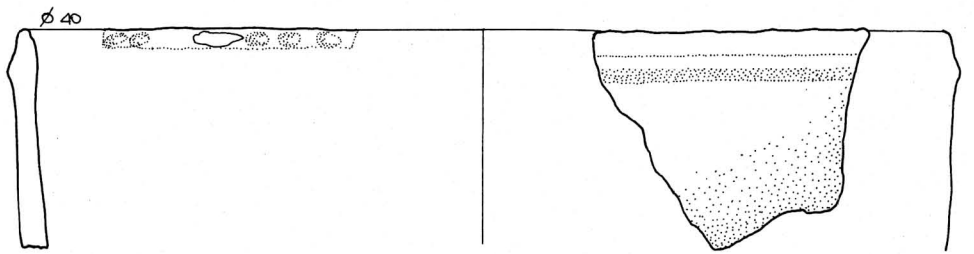

1

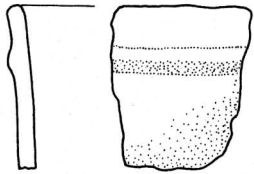

2

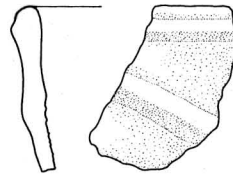

3

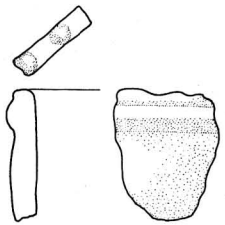

4

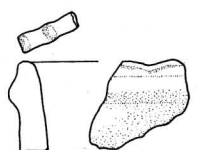

5

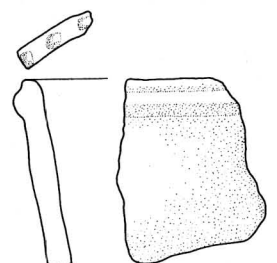

6

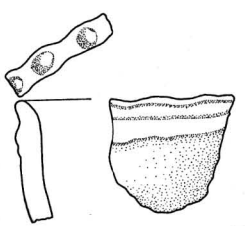

7

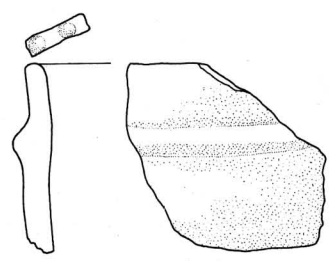

8

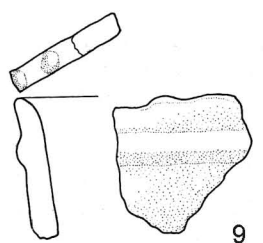

9

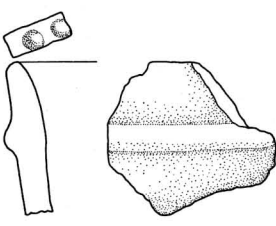

10

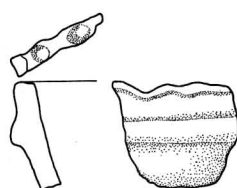

11

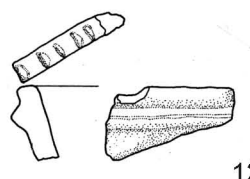

12

Tav. 110 - Santa Rosa di Poviglio: materiali ceramici provenienti dall'unità US 5175; 1-12) AE-AC 143-150 (scala 1:3).

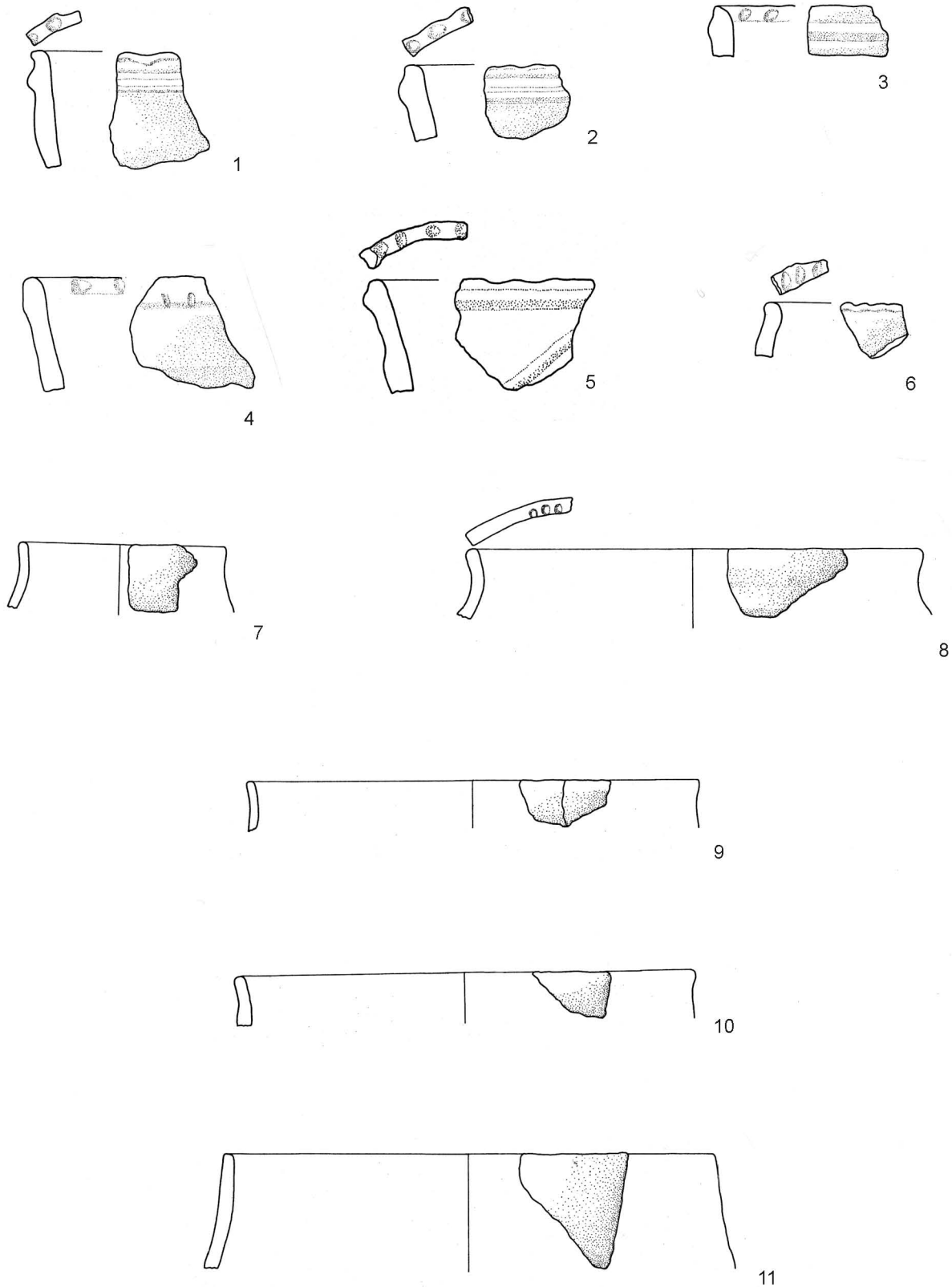

Tav. 111 - Santa Rosa di Poviglio: materiali ceramici provenienti dall'unità US 5175; 1-11) AE-AC 143-150 (scala 1:3).

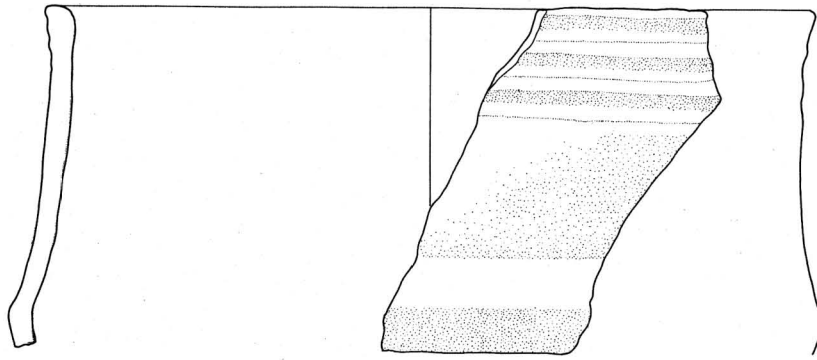

1

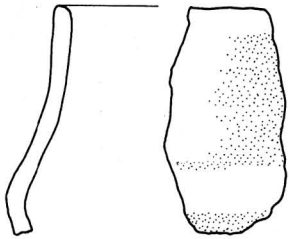

2

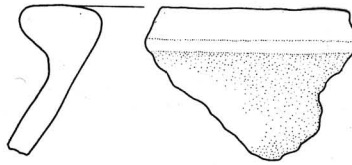

3

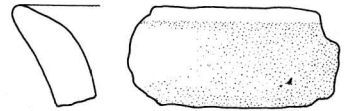

4

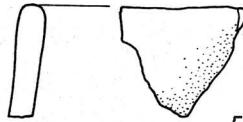

5

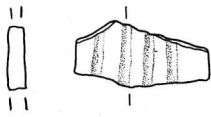

6

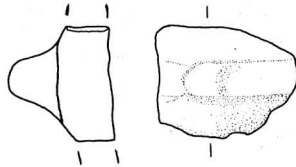

7

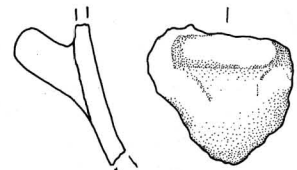

8

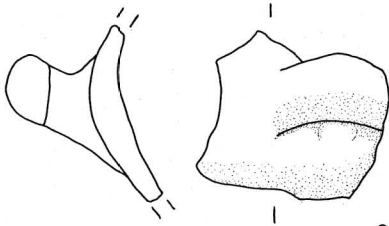

9

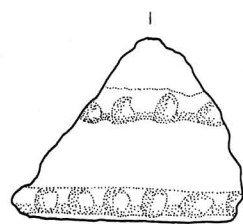

10

Tav. 112 - Santa Rosa di Poviglio: materiali ceramici provenienti dall'unità US 5175; 1-10) AE-AC 143-150 (scala 1:3).

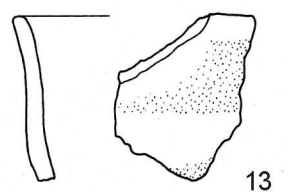
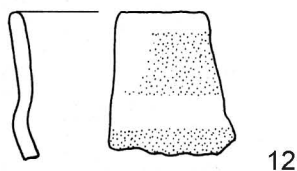
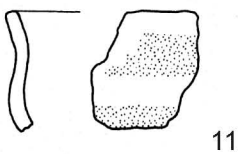
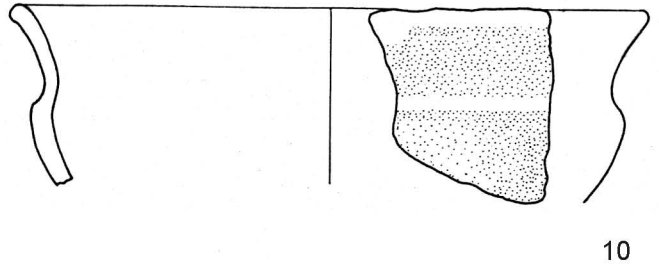
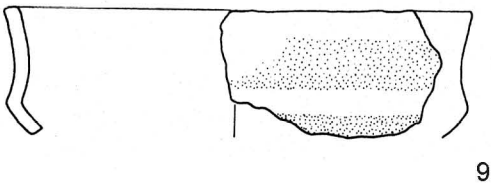
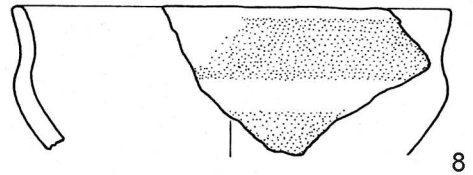
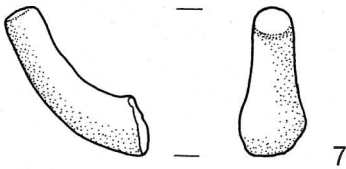
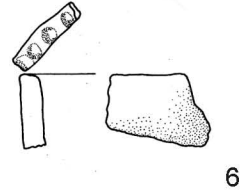
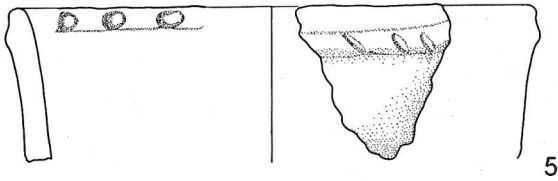
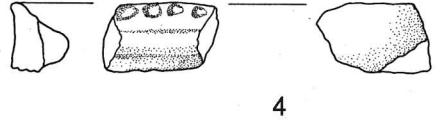
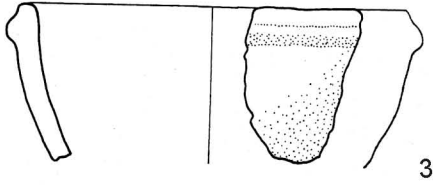
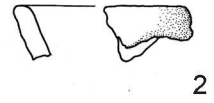
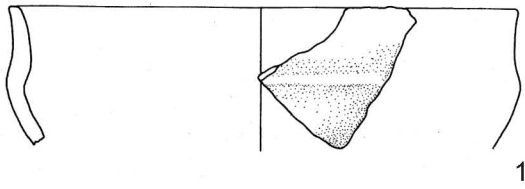

Tav. 113 - Santa Rosa di Poviglio: materiali ceramici provenienti dall'unità US 5175; 1-6) AE-AC 140-147; 7-13) AC-AB 140-142 (scala 1:3).

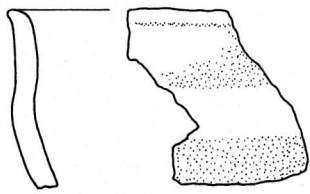

1

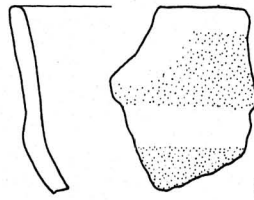

2

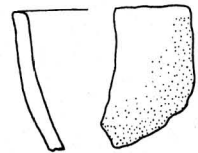

3

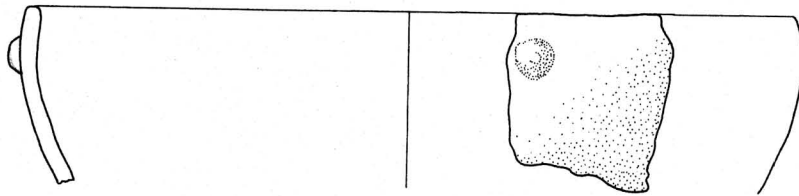

4

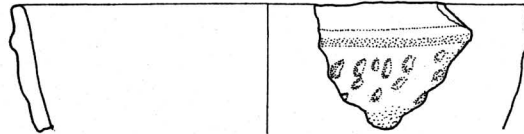
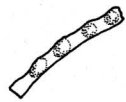

5

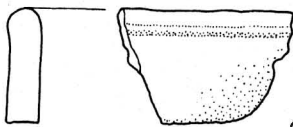

6

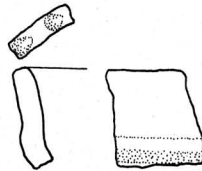

7

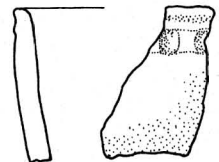

8

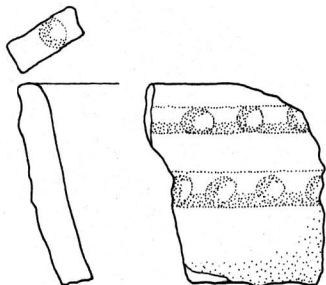

9

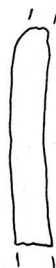

10

Tav. 114 - Santa Rosa di Poviglio: materiali ceramici provenienti dall'unità US 5175; 1-10) AC-AB 140-142 (scala 1:3).

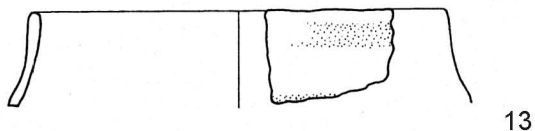
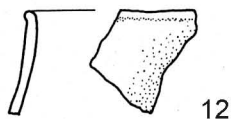
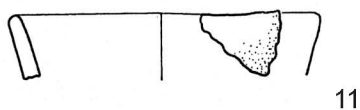
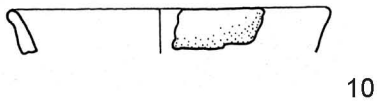
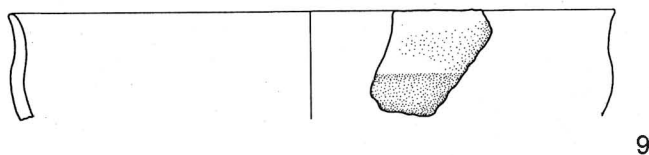
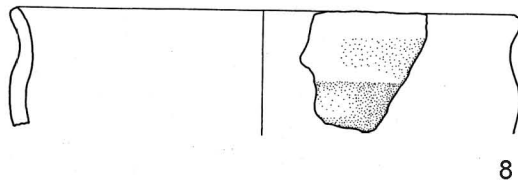
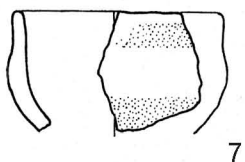
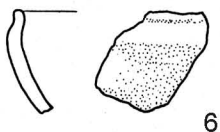
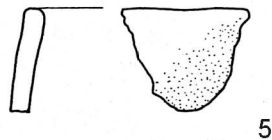
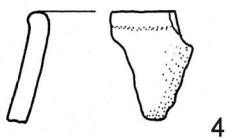
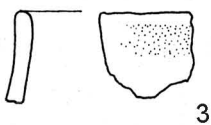
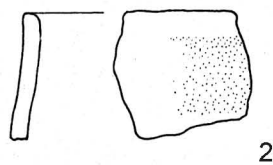
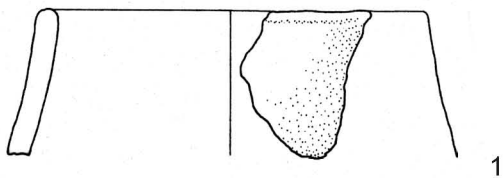

Tav. 115 - Santa Rosa di Poviglio: materiali ceramici provenienti dall'unità US 5175; 1-5) AC-AB 140-142; 6-13) AC-AA 140-146 (scala 1:3).

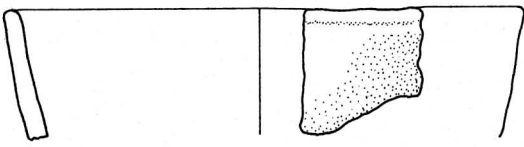

1

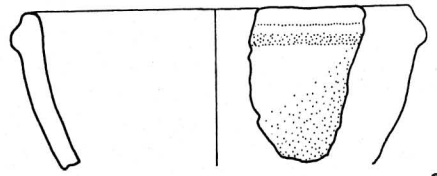

2

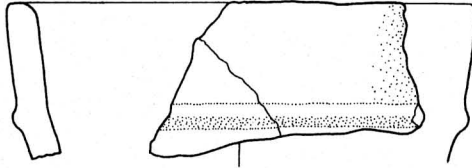
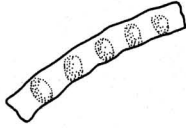

3

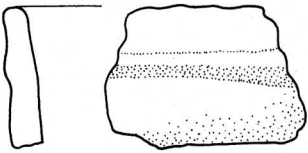

4

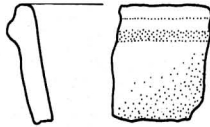

5

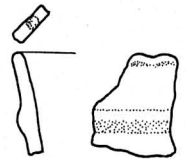

6

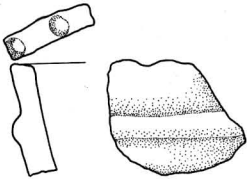

7

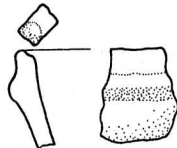

8

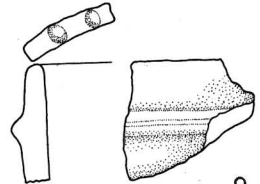

9

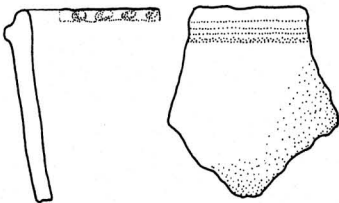

10

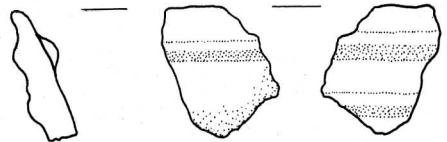

11

Tav. 116 - Santa Rosa di Poviglio: materiali ceramici provenienti dall'unità US 5175; 1-11) AC-AA 140-146 (scala 1:3).

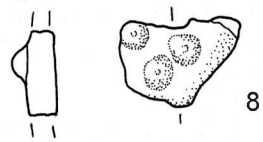
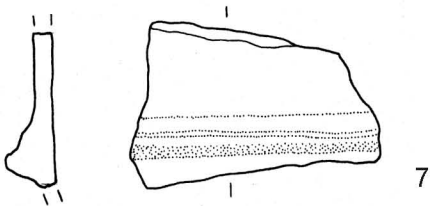
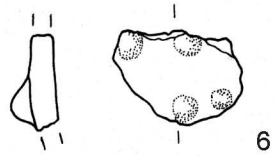
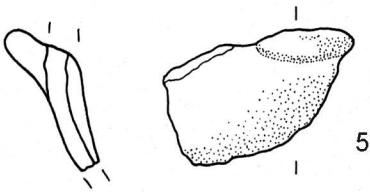
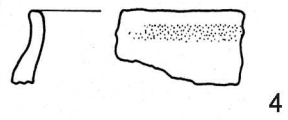
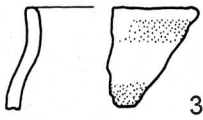
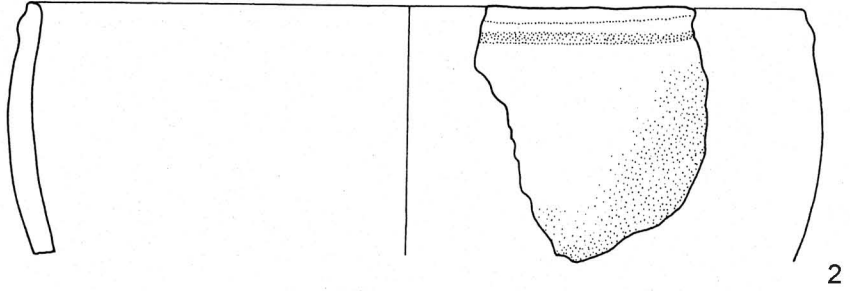
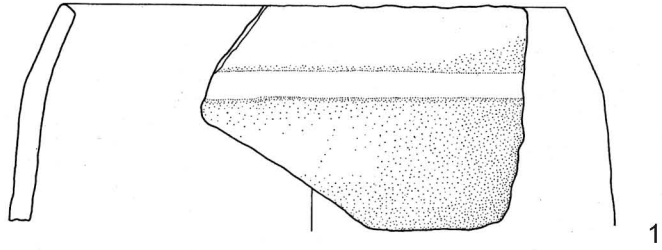

Tav. 117 - Santa Rosa di Poviglio: materiali ceramici provenienti dall'unità US 5175; 1-8) AC-AA 140-146 (scala 1:3).

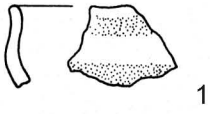

1

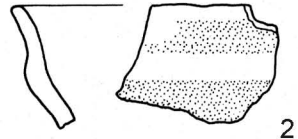

2

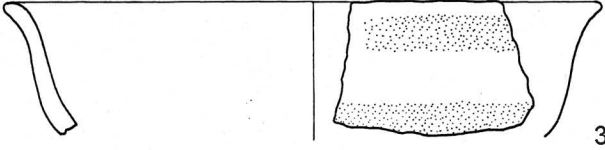

3

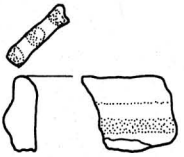

4

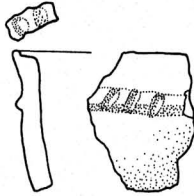

5

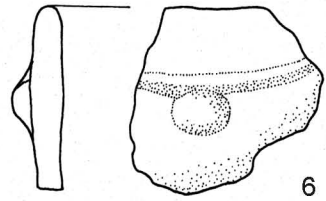

6

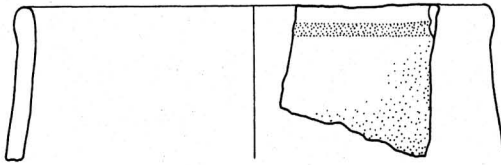

7

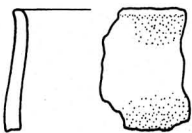

8

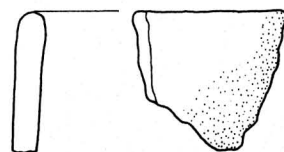

9

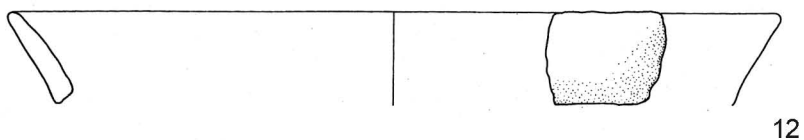
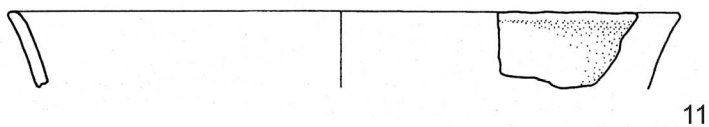
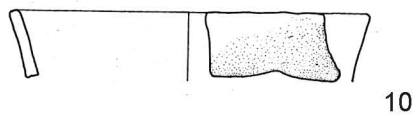
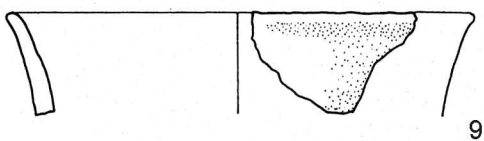
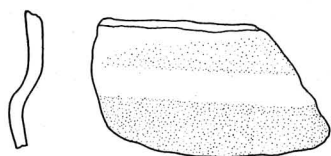
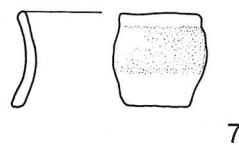
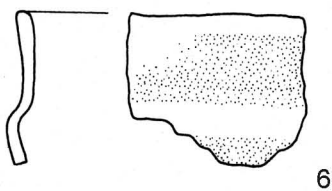
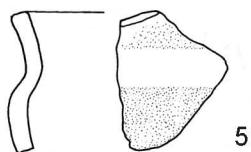
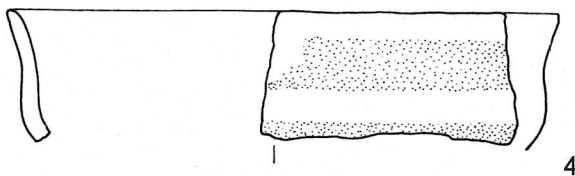
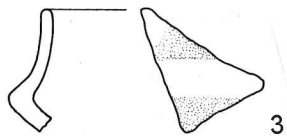
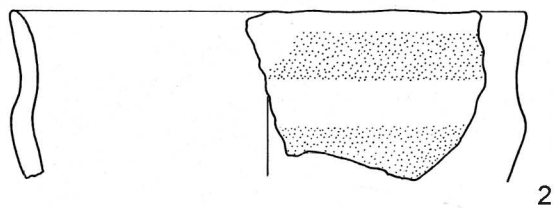
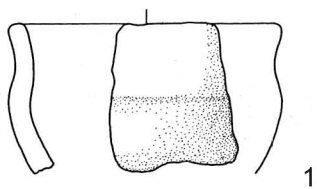

Tav. 119 - Santa Rosa di Poviglio: materiali ceramici provenienti dall'unità US 5175; 1-12) AC-AAZ 141-142 (scala 1:3).

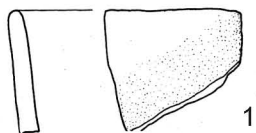

1

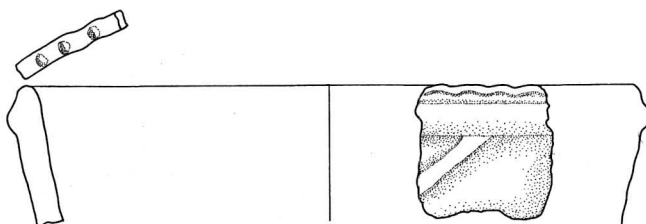

4

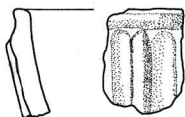

2

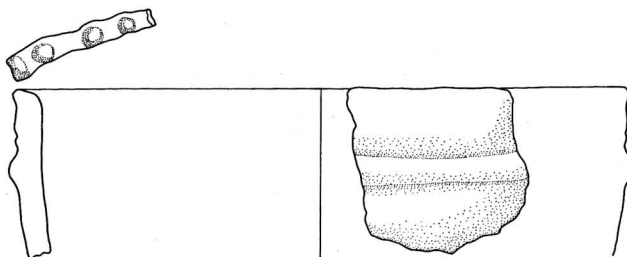

5

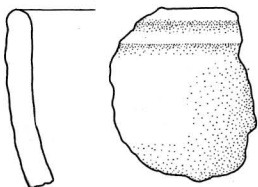

3

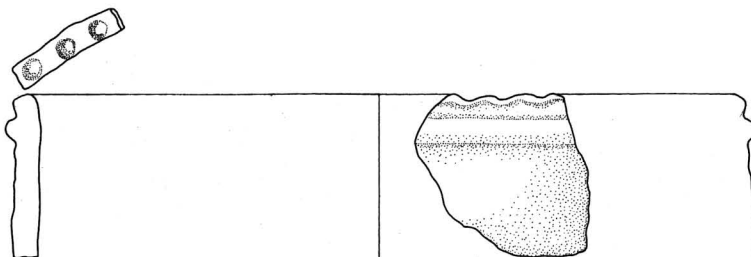

6

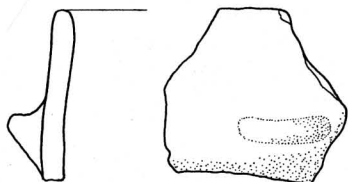

8

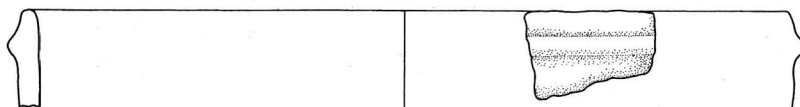

7

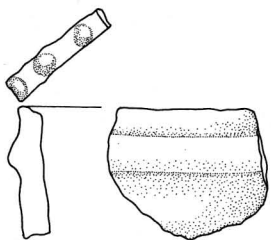

9

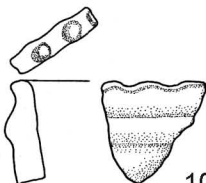

10

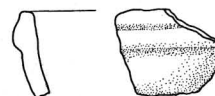

11

Tav. 120 - Santa Rosa di Poviglio: materiali ceramici provenienti dall'unità US 5175; 1-11) AC-AAZ 141-147 (scala 1:3).

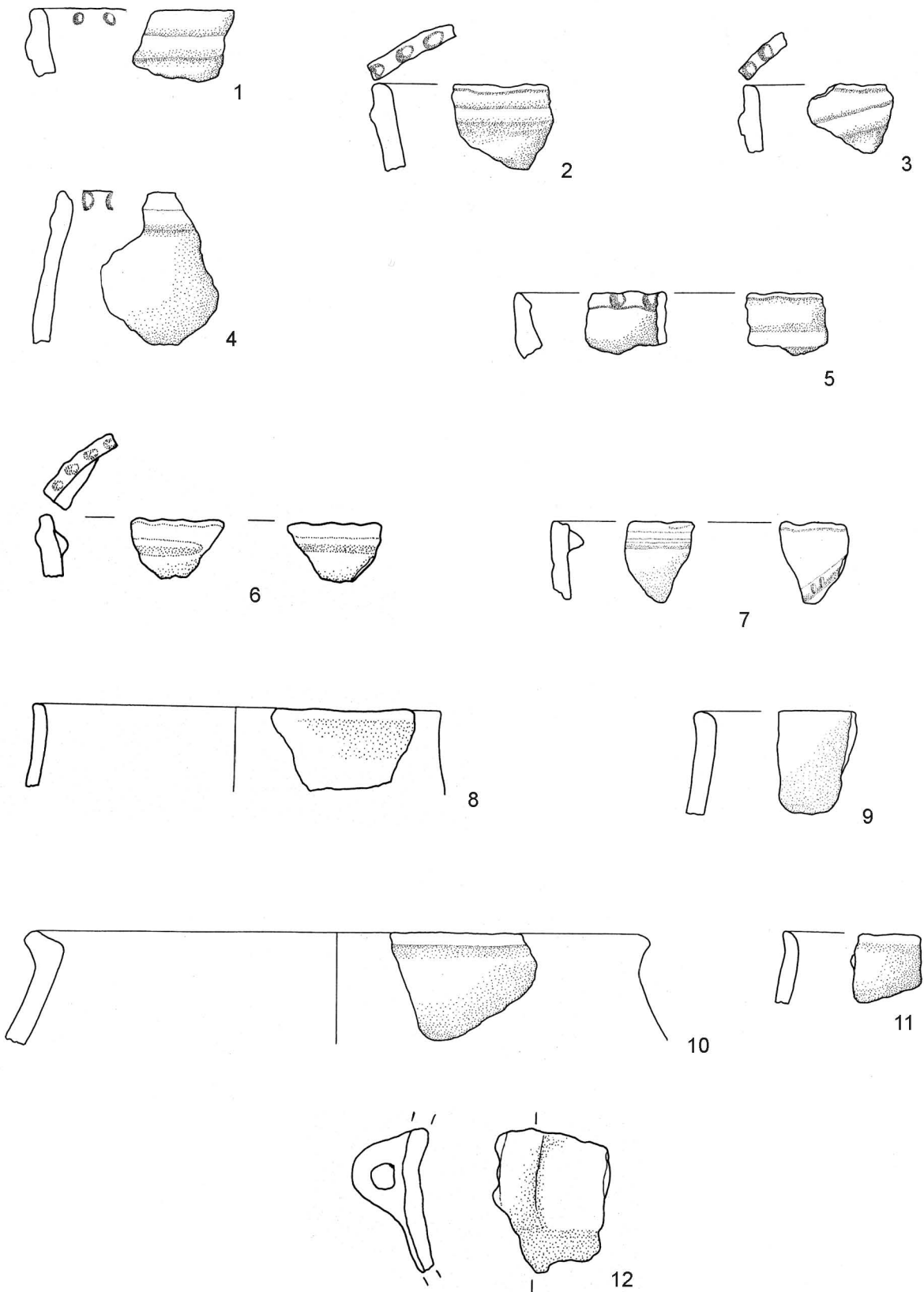

Tav. 121 - Santa Rosa di Poviglio: materiali ceramici provenienti dall'unità US 5175; 1-12) AC-AAZ 141-147 (scala 1:3).

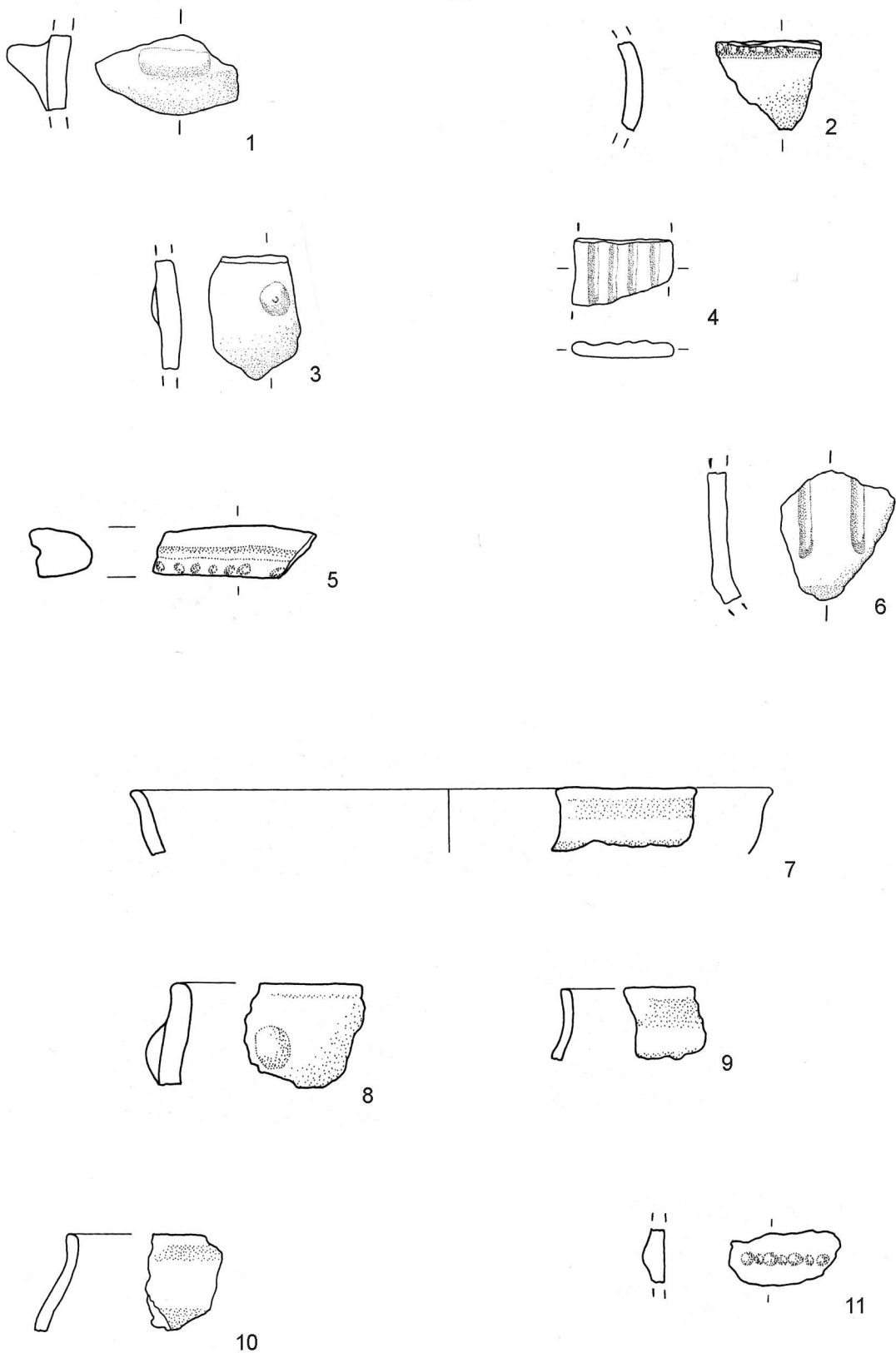

Tav. 122 - Santa Rosa di Poviglio: materiali ceramici provenienti dall'unità US 5175; 1-6) AC-AAZ 141-147; 7-11) AA-AAS 143-145 (scala 1:3).

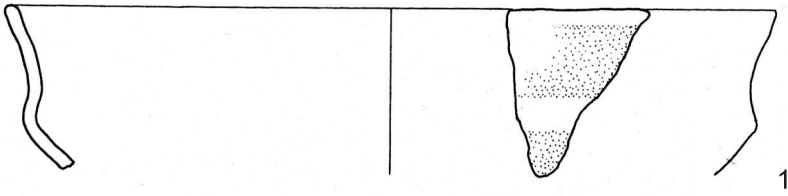

1

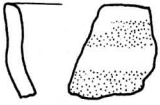

2

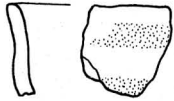

3

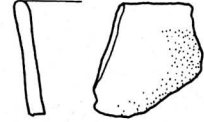

4

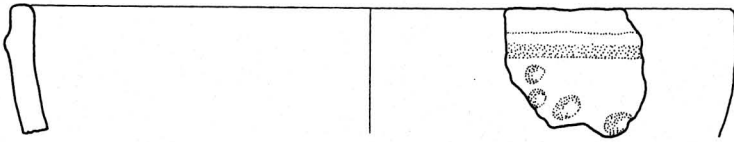

5

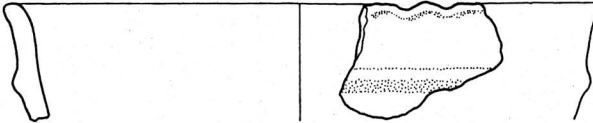

6

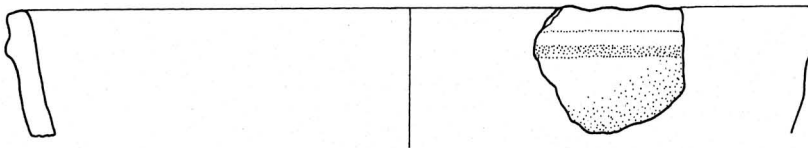

7

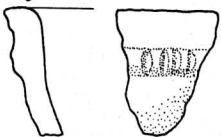

8

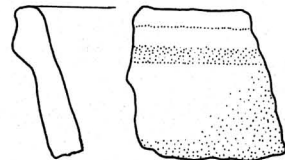

9

Tav. 123 - Santa Rosa di Poviglio: materiali ceramici provenienti dall'unità US 5175; 1-9) AA-AAZ 146-149 (scala 1:3).

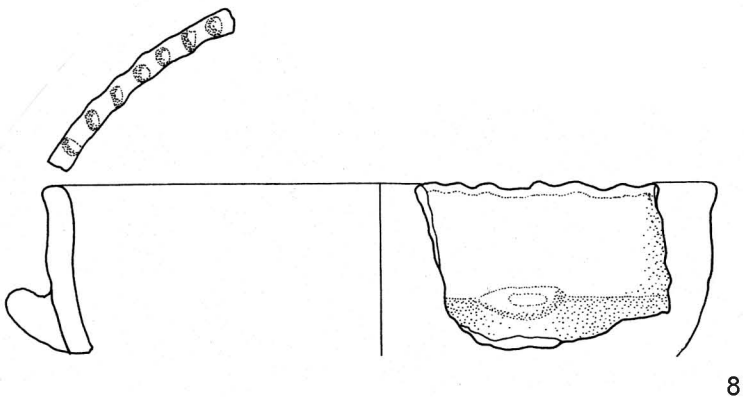
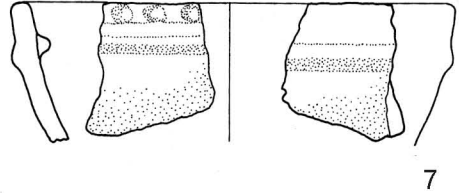
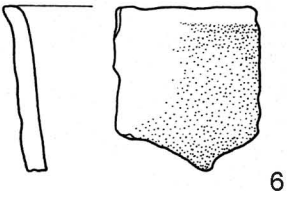
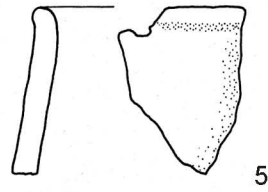
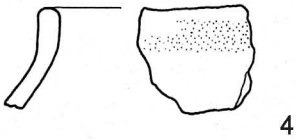
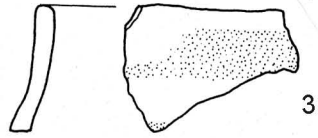
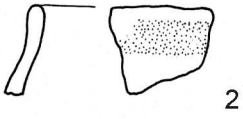
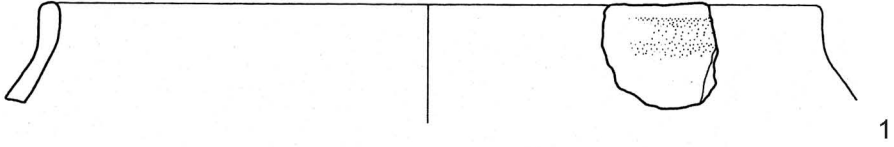

Tav. 124 - Santa Rosa di Poviglio: materiali ceramici provenienti dall'unità US 5175; 1-5) AA-AAZ 146-149; 6-8) AA-AAV 140-143 (scala 1:3).

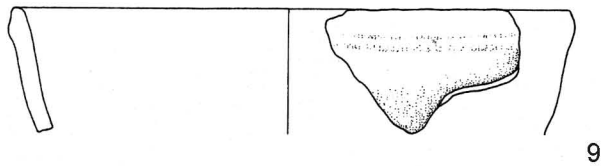
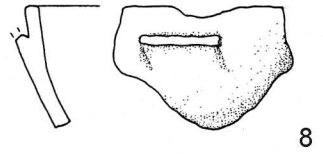
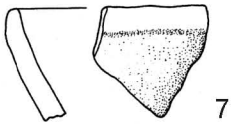
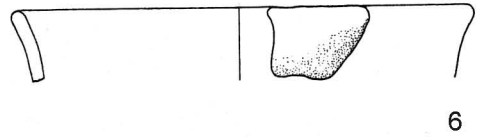
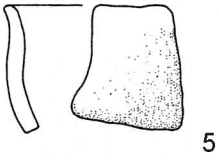
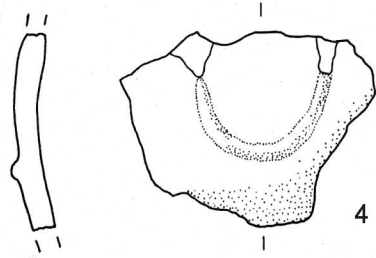
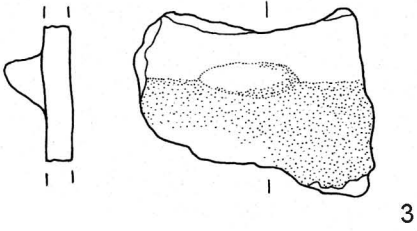
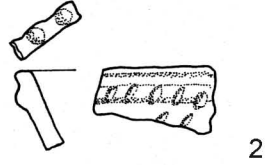
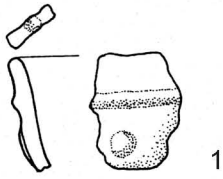

Tav. 125 - Santa Rosa di Poviglio: materiali ceramici provenienti dall'unità US 5175; 1-4) AA-AAV 140-143; 5-9) AAZ-AAV 140-144 (scala 1:3).

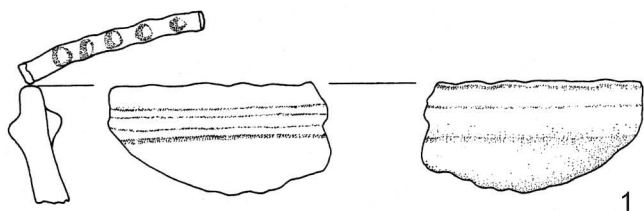

1

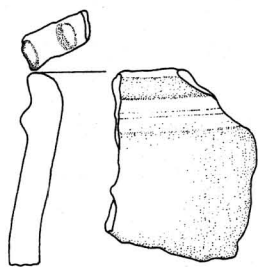

2

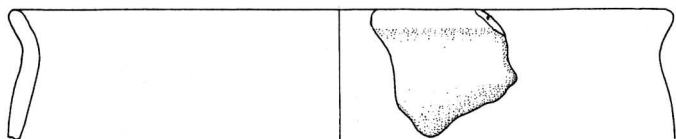

3

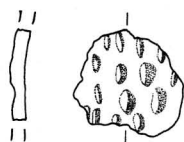

4



5

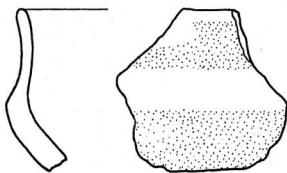

6

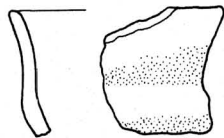

7

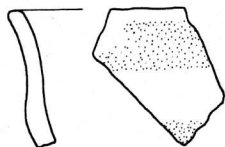

8



9

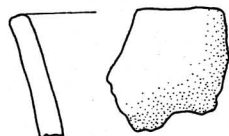

10



11



12

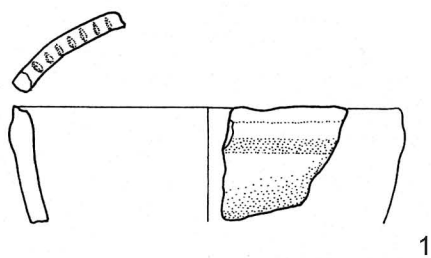

1

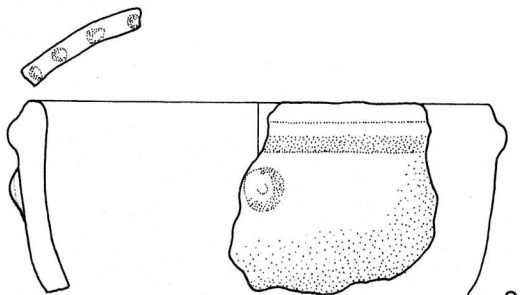

2

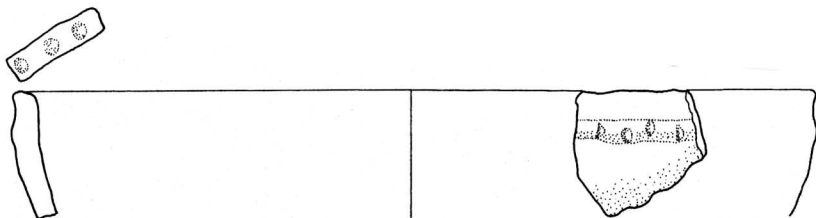

3

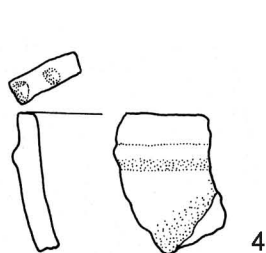

4

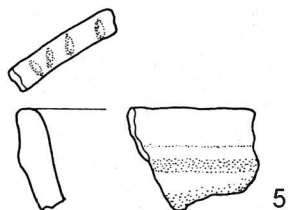

5

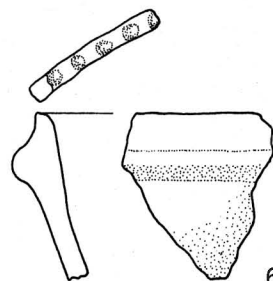

6

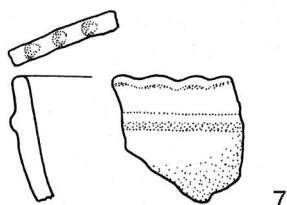

7

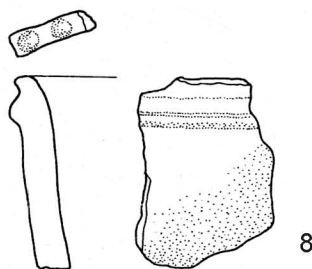

8

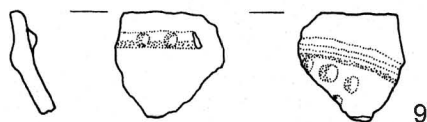

9

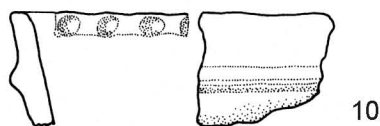

10

Tav. 127 - Santa Rosa di Poviglio: materiali ceramici provenienti dall'unità US 5175; 1-10) AAV-AAT 143-145 (scala 1:3).

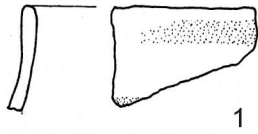

1



2

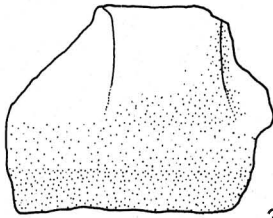
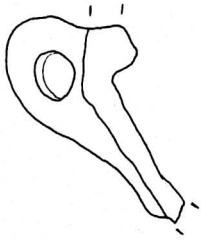

3

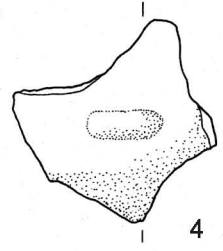

4

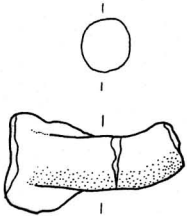

5

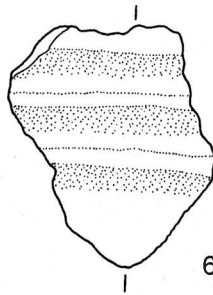

6

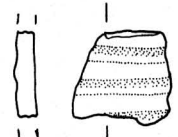

7

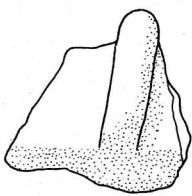

8

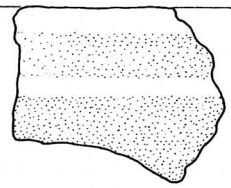
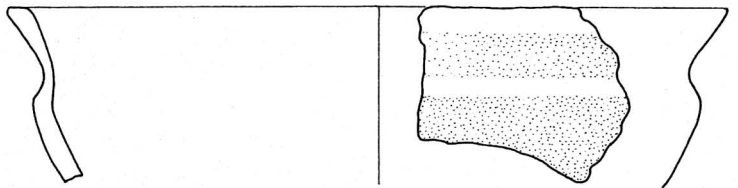

9

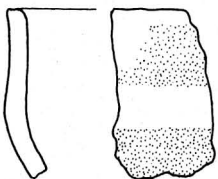

10

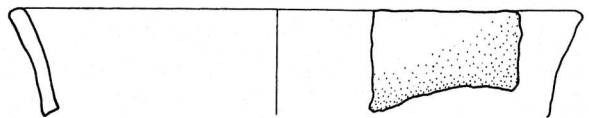

11

Tav. 128 - Santa Rosa di Poviglio: materiali ceramici provenienti dall'unità US 5175; 1-7) AAV-AAT 143-145; 8-11) AAU-AAT 141-142 (scala 1:3).

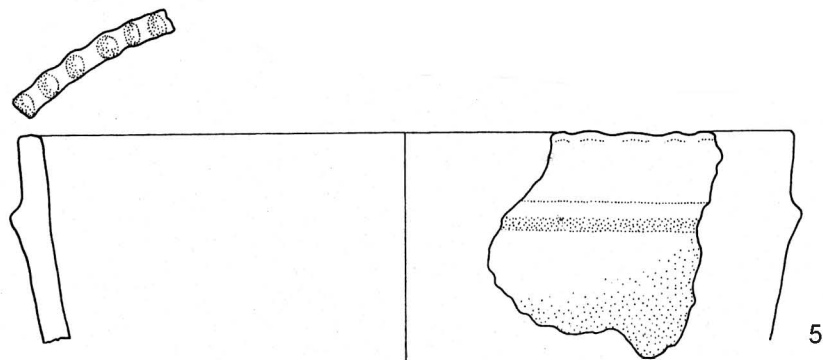
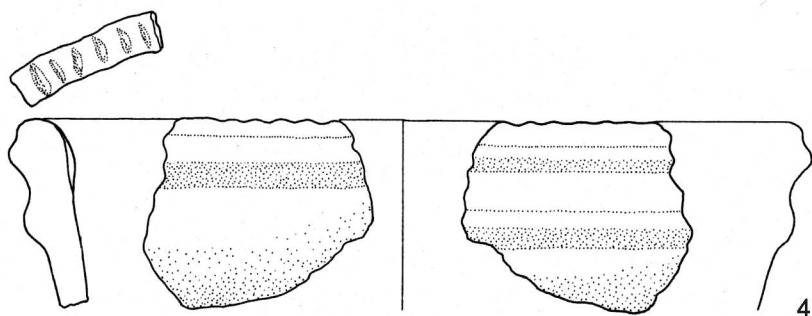
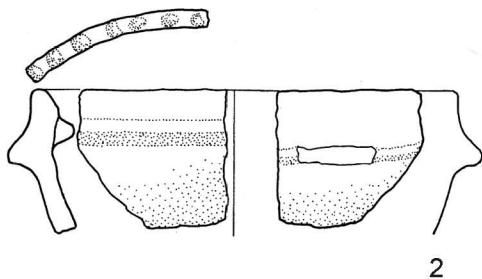
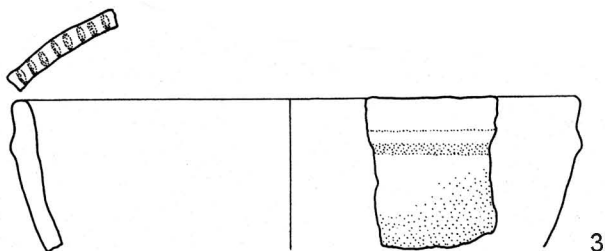
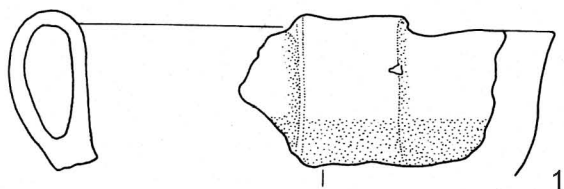

Tav. 129 - Santa Rosa di Poviglio: materiali ceramici provenienti dall'unità US 5175; 1-5) AAU-AAT 141-142 (scala 1:3).

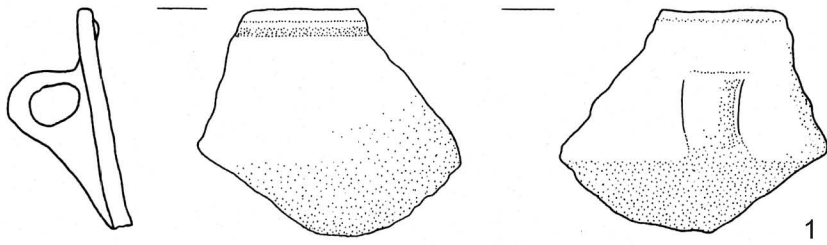

1

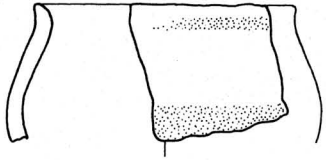

2

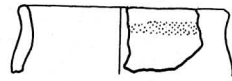

3

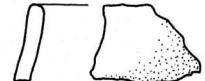

4

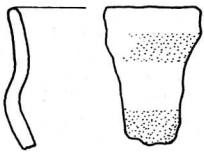

5

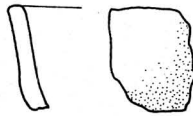

6

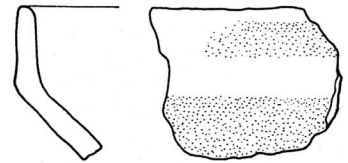

7

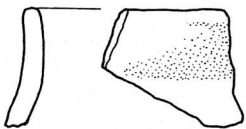

8

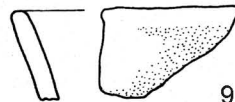

9



10

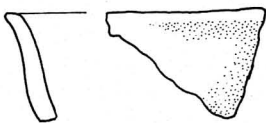

11

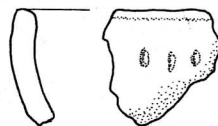

12

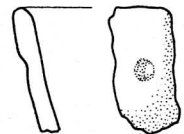

13

Tav. 130 - Santa Rosa di Poviglio: materiali ceramici provenienti dall'unità US 5175; 1-4) AAU-AAT 141-142; 5-13) AAT-AAI 140-142 (scala 1:3).

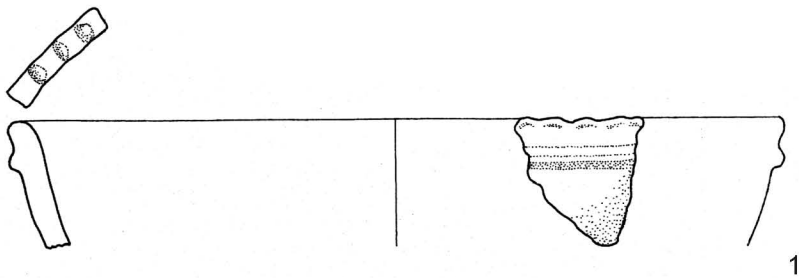

1

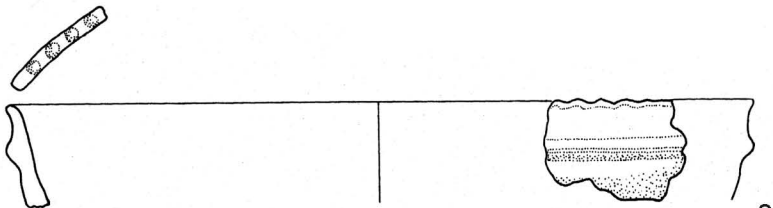

2

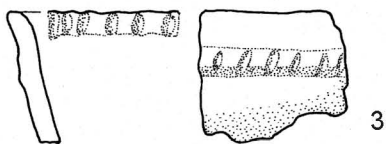

3

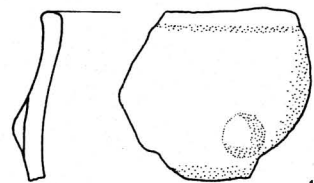

4

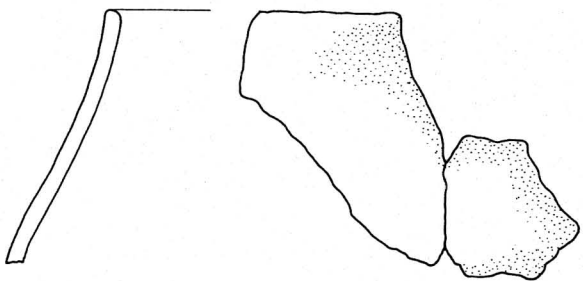

5

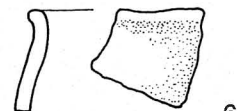

6



7

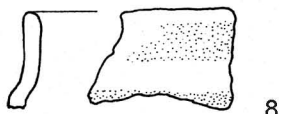

8

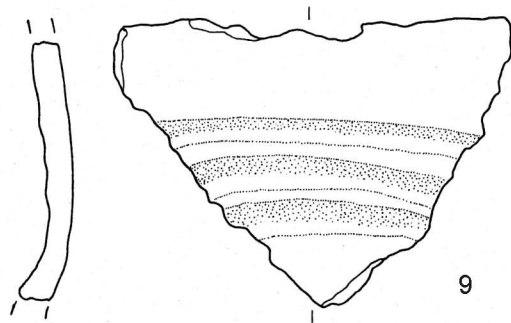

9

Tav. 131 - Santa Rosa di Poviglio: materiali ceramici provenienti dall'unità US 5175; 1-9) AAT-AAI 140-142 (scala 1:3).

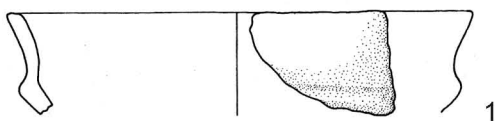

1

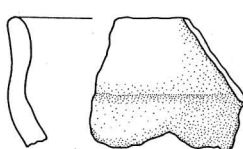

2

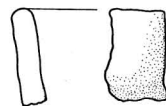

3

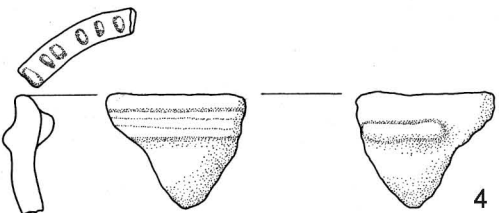

4

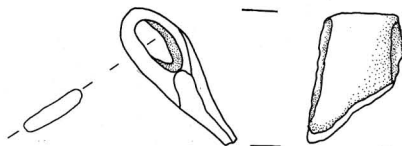

5

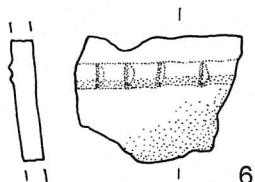

6

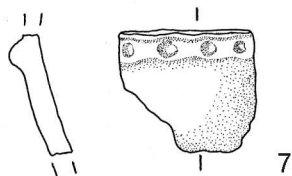

7

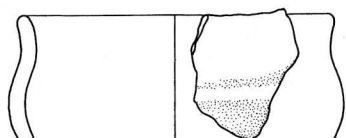

8



9

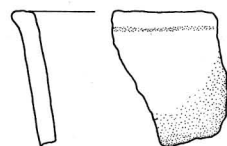

10

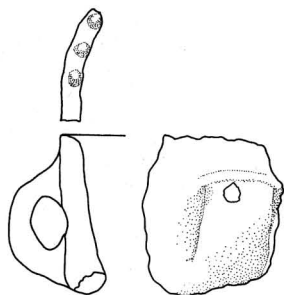

11

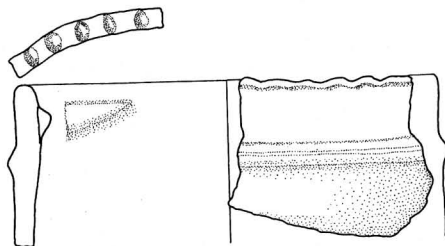

12

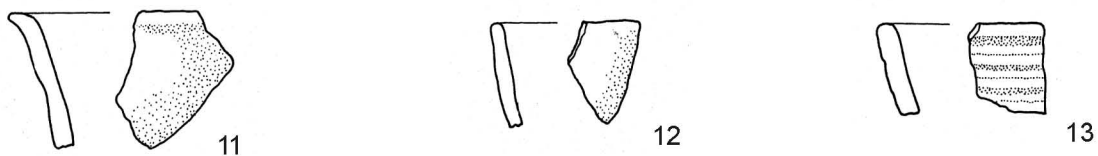
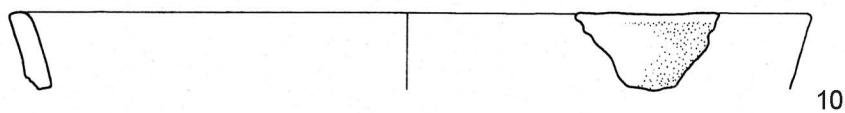
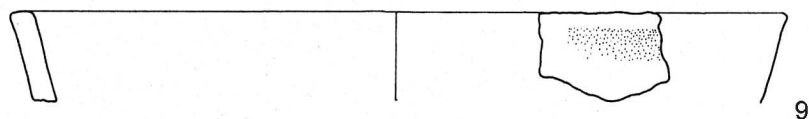
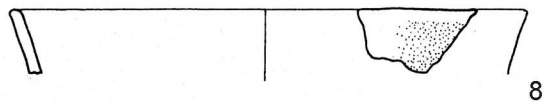
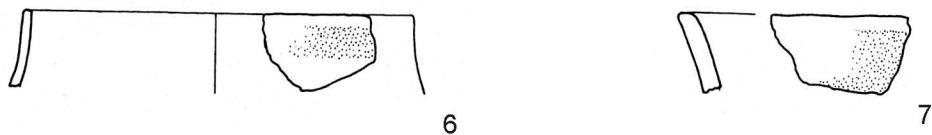
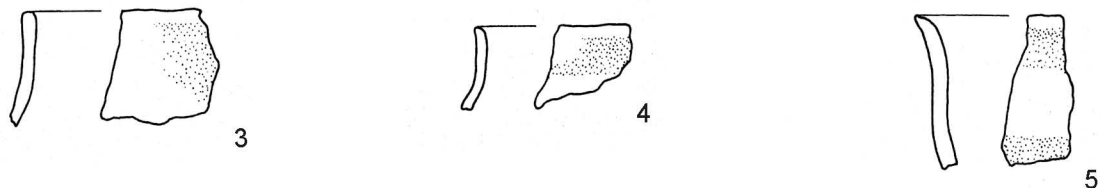
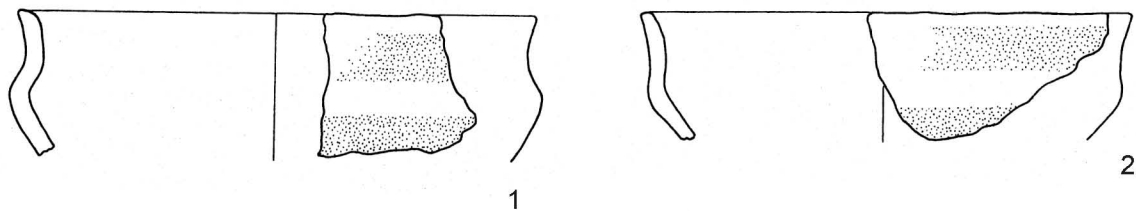

Tav. 133 - Santa Rosa di Poviglio: materiali ceramici provenienti dall'unità US 5175; 1-13) AAS-AAQ 142-148 (scala 1:3).

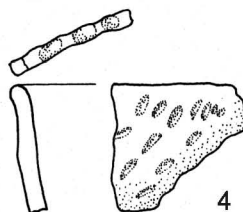
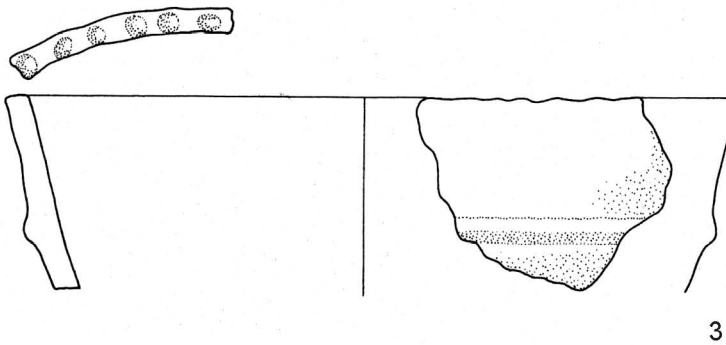
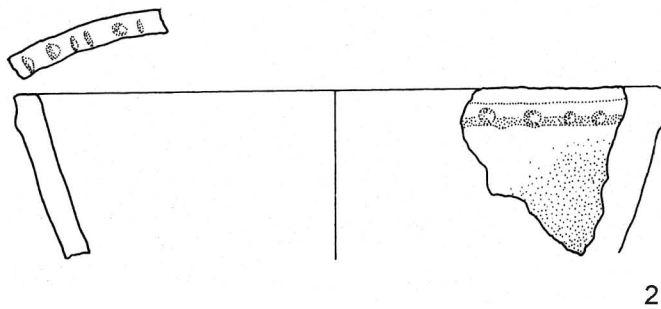
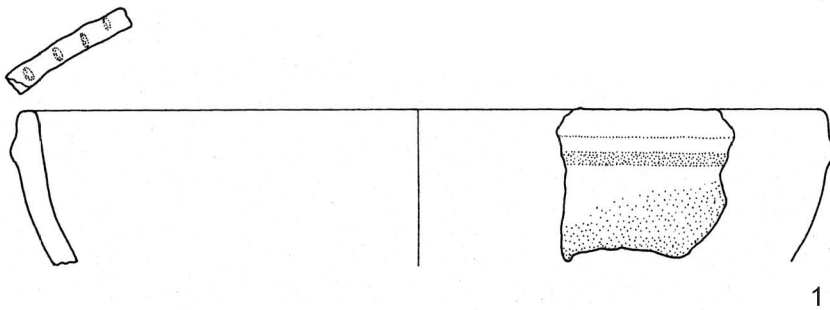

Tav. 134 - Santa Rosa di Poviglio: materiali ceramici provenienti dall'unità US 5175; 1-4) AAS-AAQ 142-148 (scala 1:3).

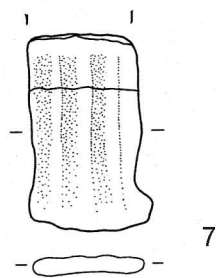
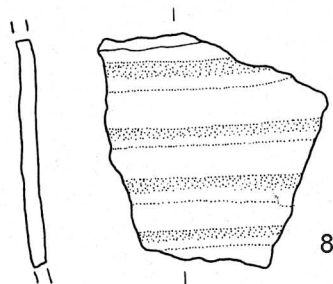
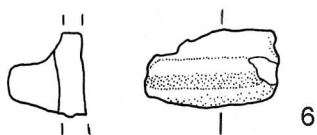
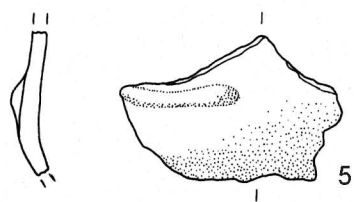
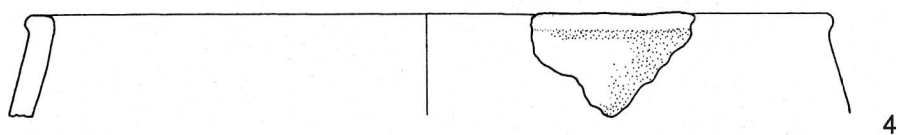
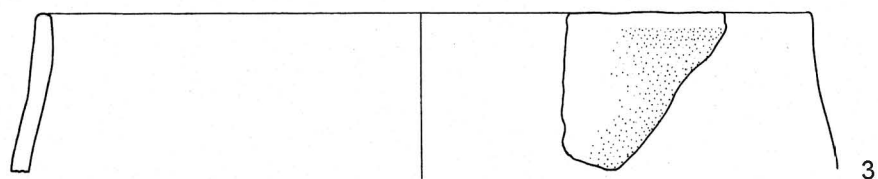
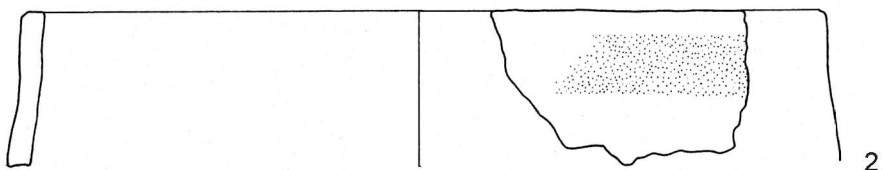
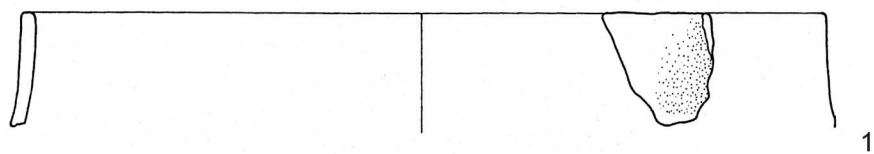

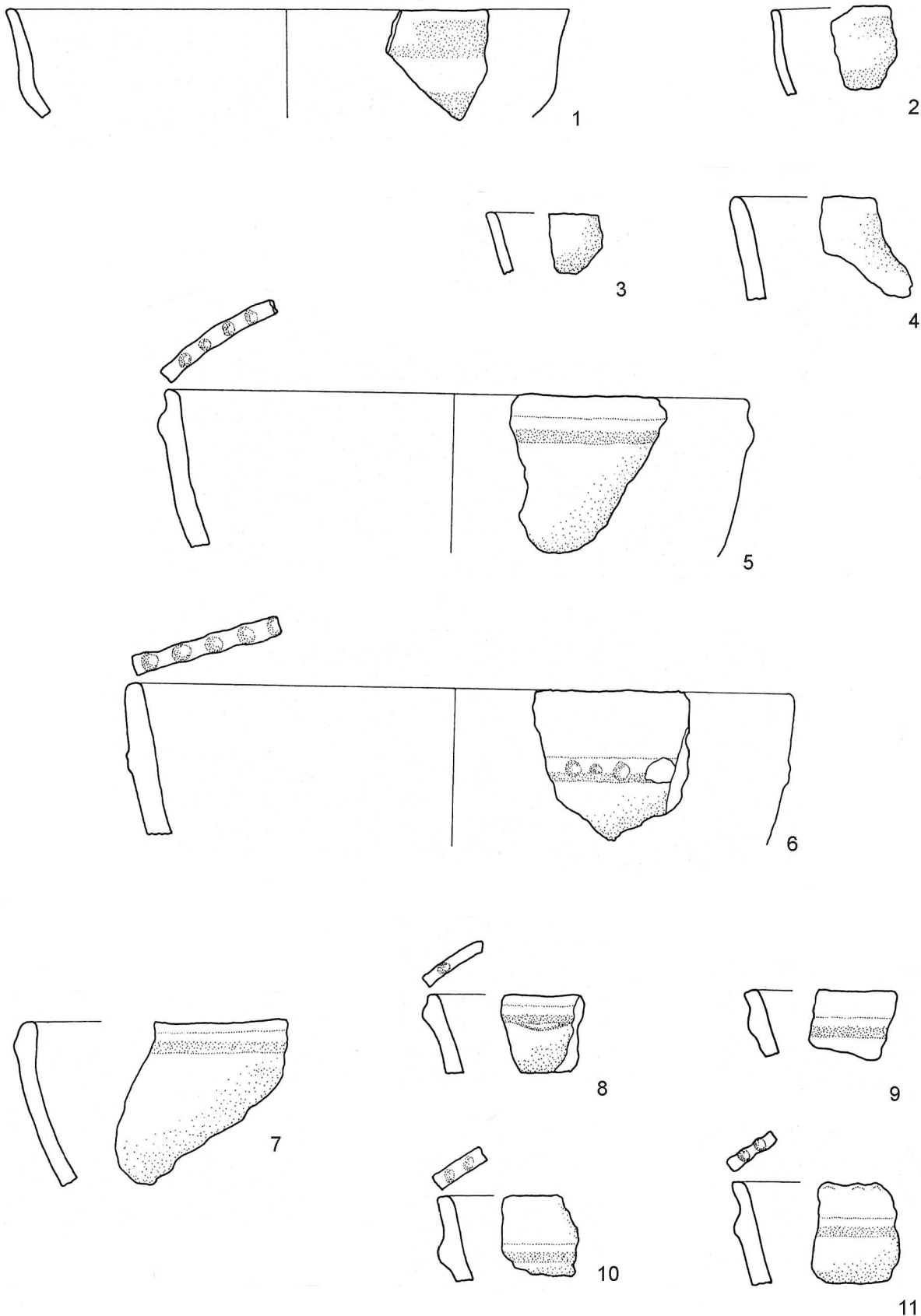

Tav. 136 - Santa Rosa di Poviglio: materiali ceramici provenienti dall'unità US 5175; 1-11) AAR-AAQ 140-145 (scala 1:3).

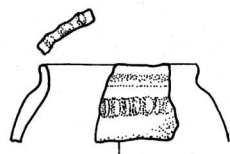
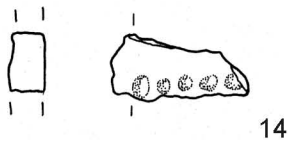
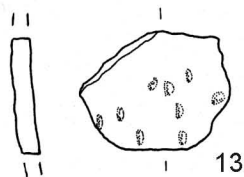
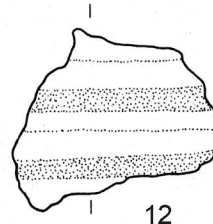
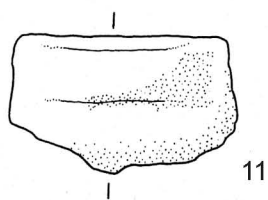
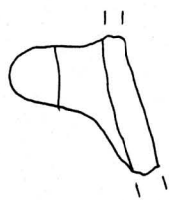
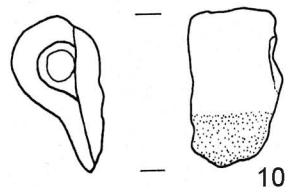
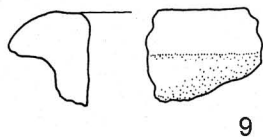
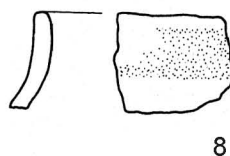
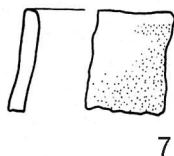
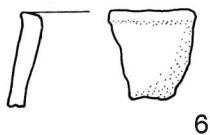
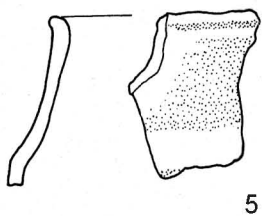
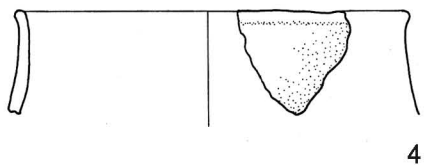
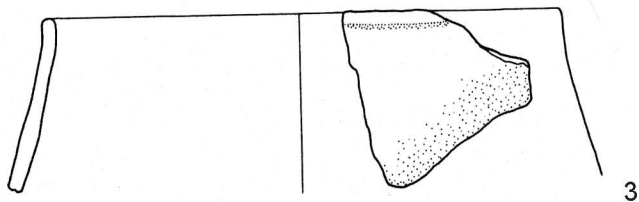
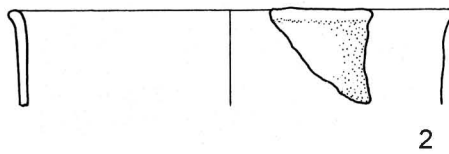
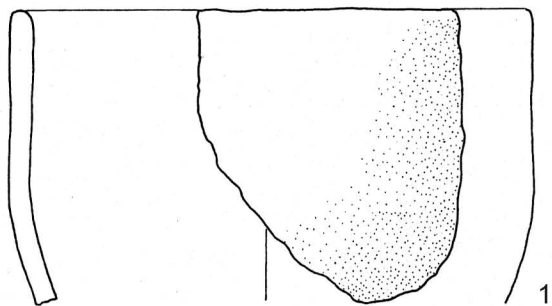

15

Tav. 137 - Santa Rosa di Poviglio: materiali ceramici provenienti dall'unità US 5175; 1-15) AAR-AAQ 140-145 (scala 1:3).

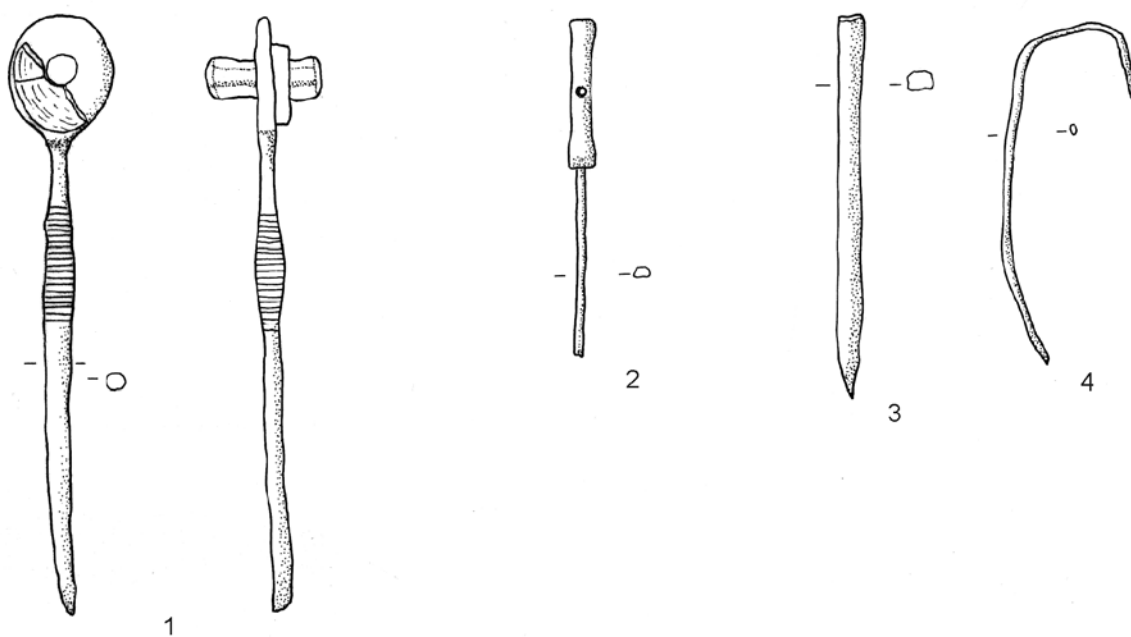

Tav. 138 - Santa Rosa di Poviglio: materiali in bronzo provenienti dall'unità US 5175; 1) AAZ 143; 2) AAT 142; 3) AAZ 144; 4) AAV 145 (grandezza naturale).

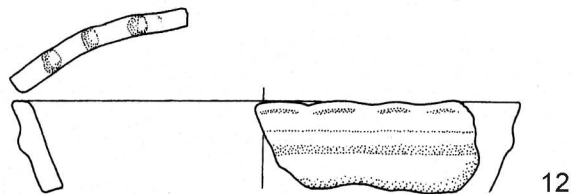
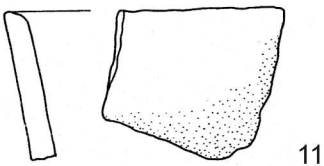
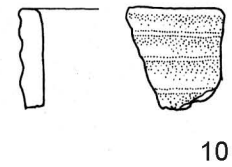
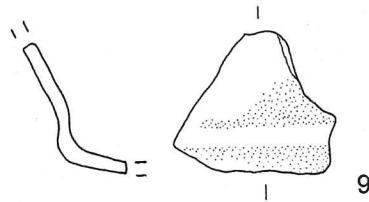
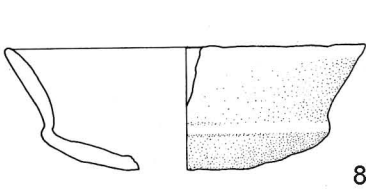
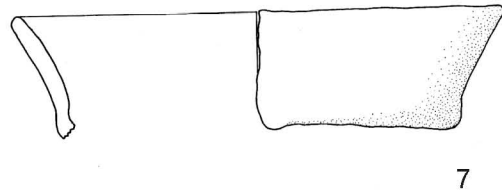
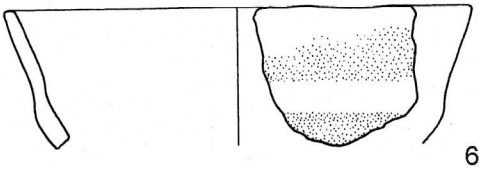
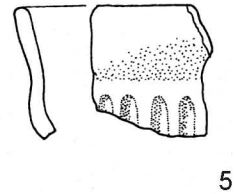
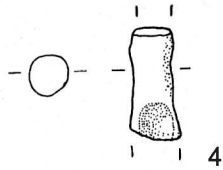
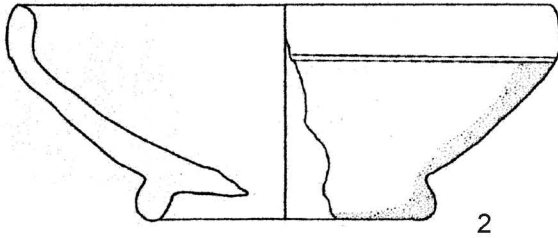
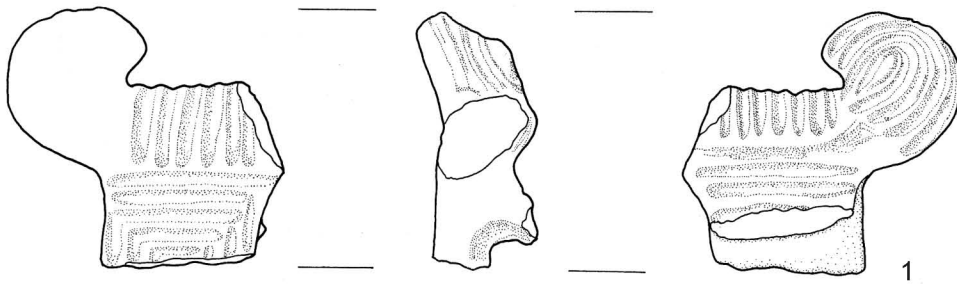

Tav. 139 - Santa Rosa di Poviglio: materiali ceramici provenienti dall'unità US 5974 (scala 1:3).

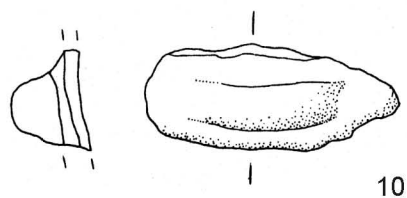
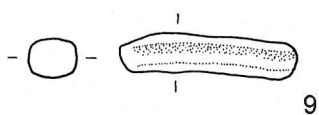
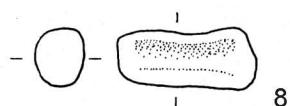
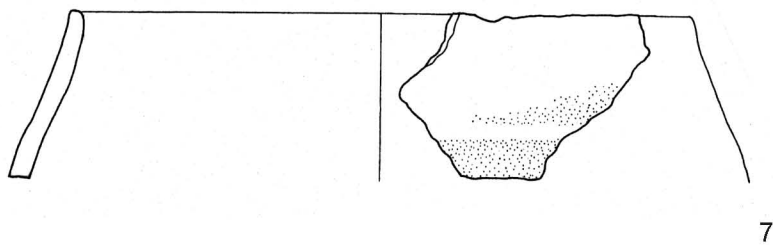
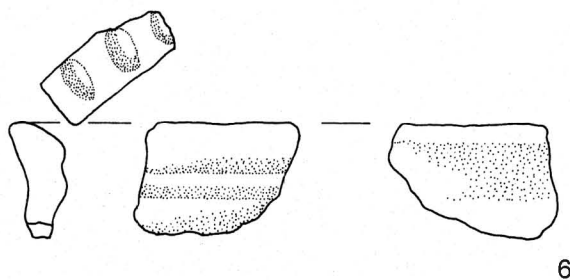
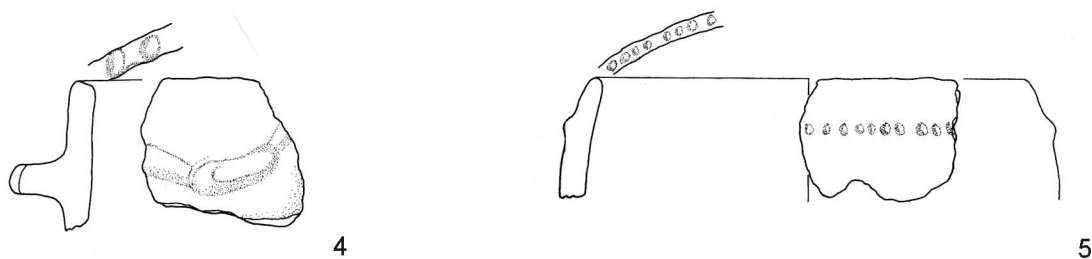
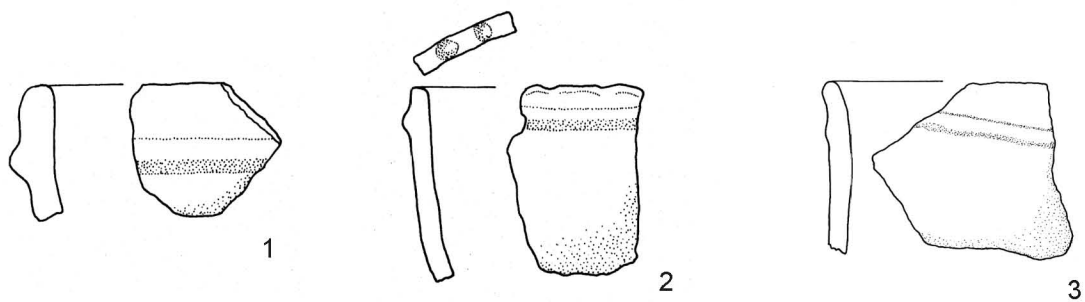

Tav. 140 - Santa Rosa di Poviglio: materiali ceramici provenienti dall'unità US 5974 (scala 1:3).

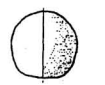
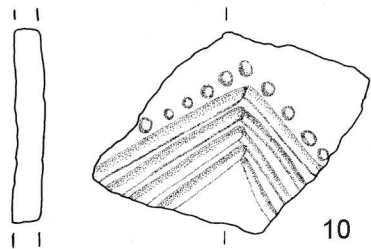
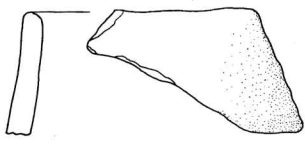
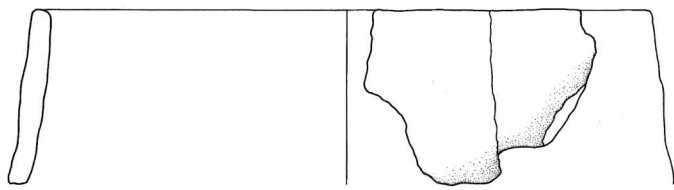
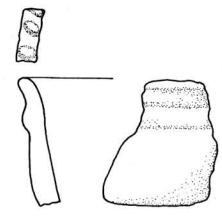
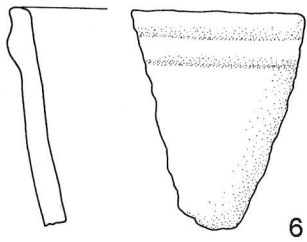
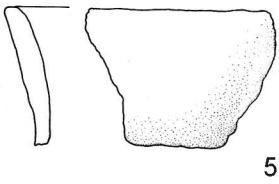
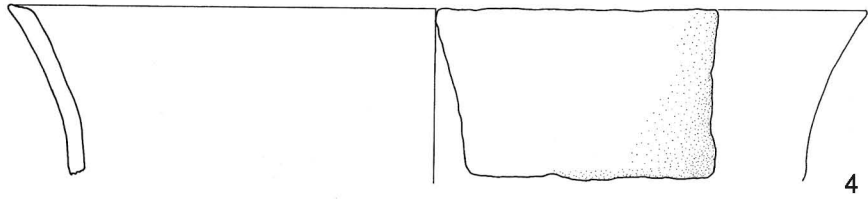
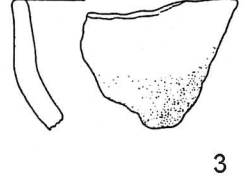
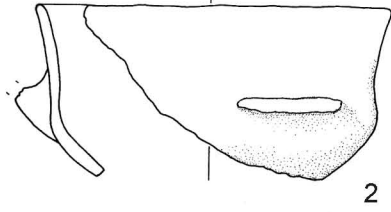
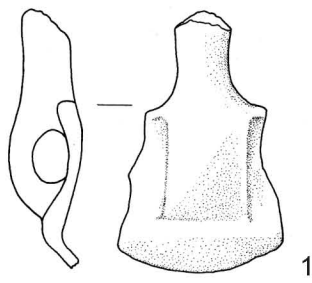

Tav. 141 - Santa Rosa di Poviglio: materiali ceramici e fittili provenienti dall'unità US 6089=5974 (scala 1:3).

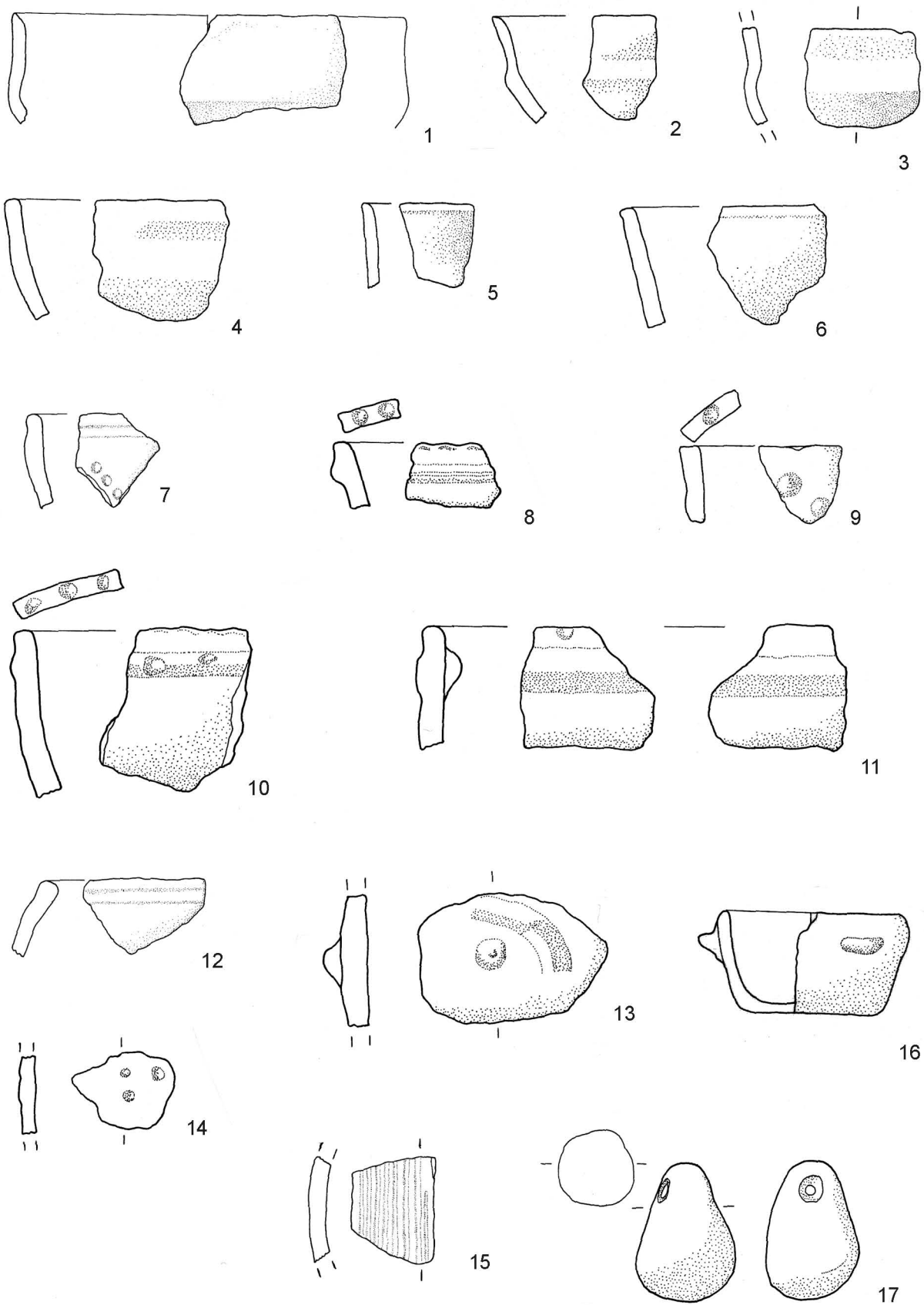

Tav. 142 - Santa Rosa di Poviglio: materiali ceramici e fittili provenienti dall'unità US 5993 (nn°1-16 scala 1:3; n° 17 scala 1:2).

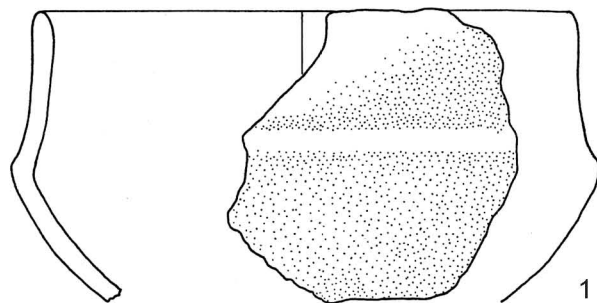

1

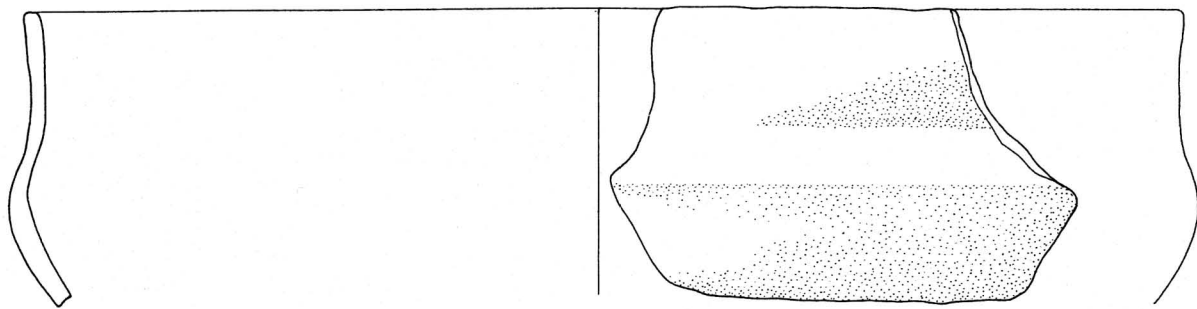

2

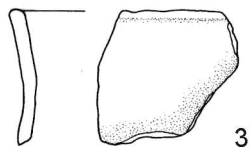

3

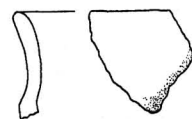

5

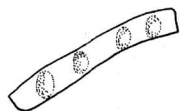

7

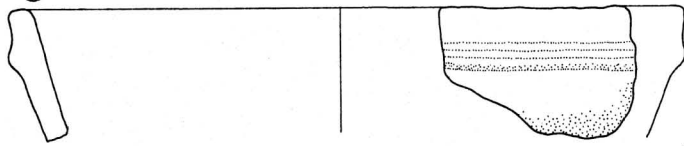

4

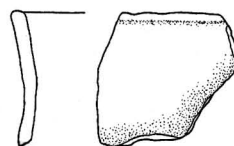

6

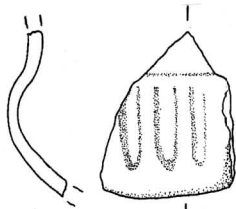
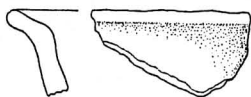

8

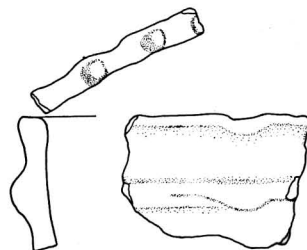

9

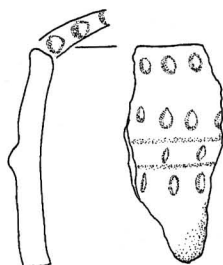

10



11

Tav. 143 - Santa Rosa di Poviglio: materiali ceramici provenienti dalla canaletta US 6001; 1) US 6739; 2-4) US 6009; 5-11) US 6000 (scala 1:3).

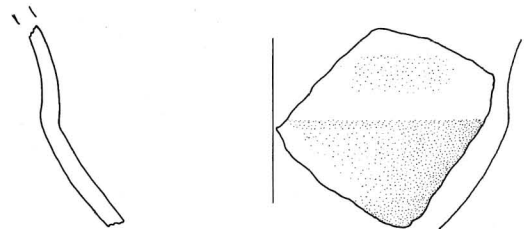
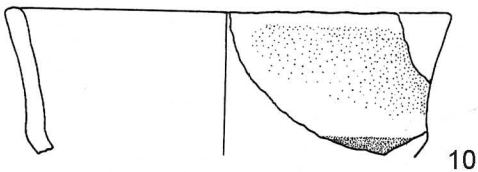
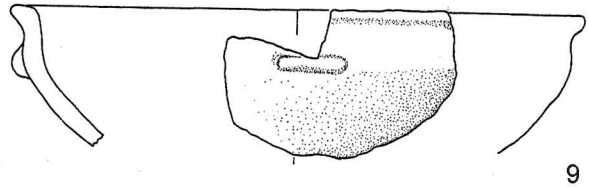
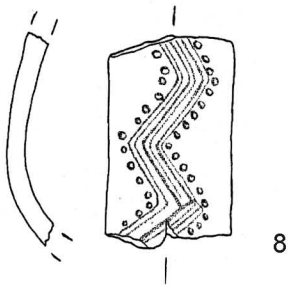
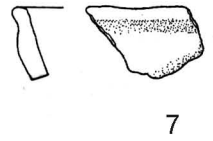
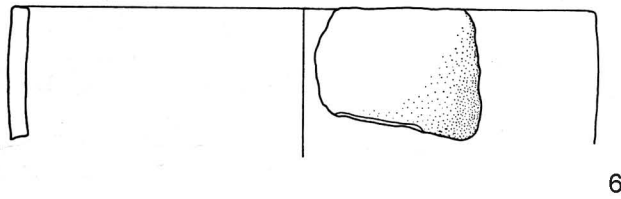
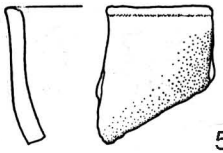
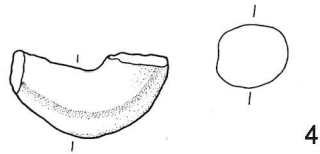
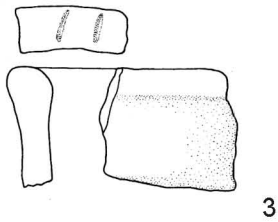
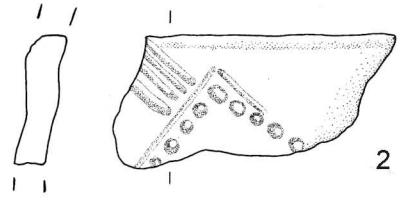
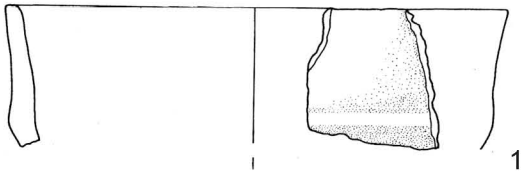

Tav. 144 - Santa Rosa di Poviglio: materiali ceramici provenienti dalle strutture del centro fossato; 1-4) da US 6171; 5-8) da US 6113; 9-12) da US 6109 (scala 1:3).

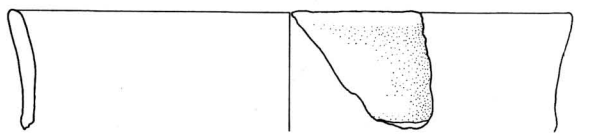

1

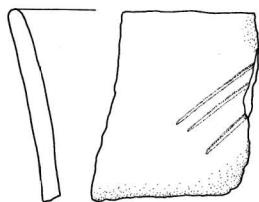

2

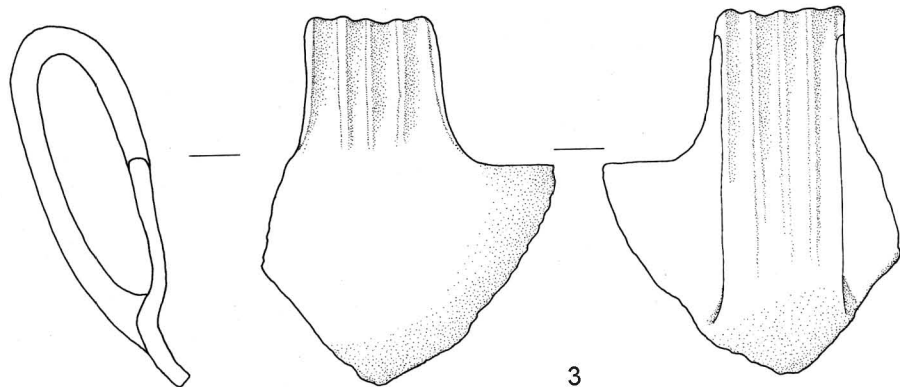

3

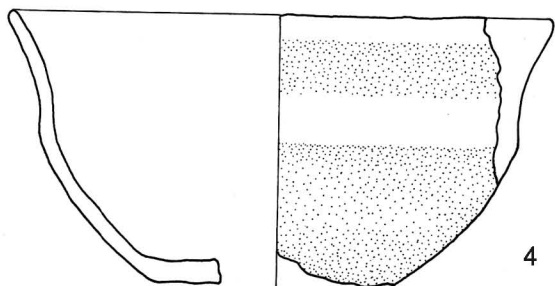

4

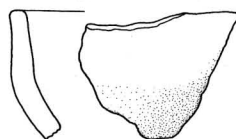

5



6

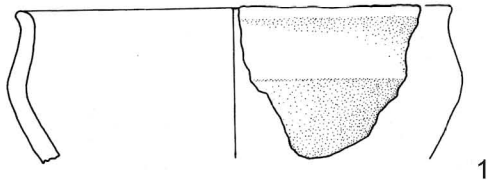

1

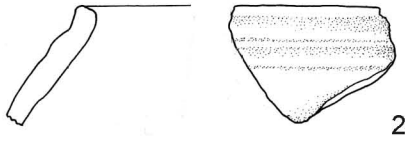

2

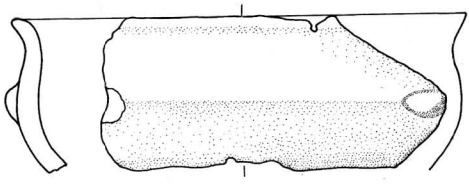

3

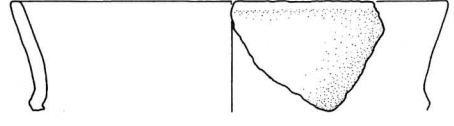

4

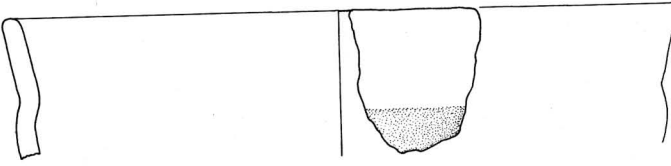

5

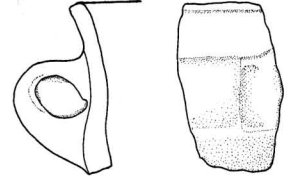

6

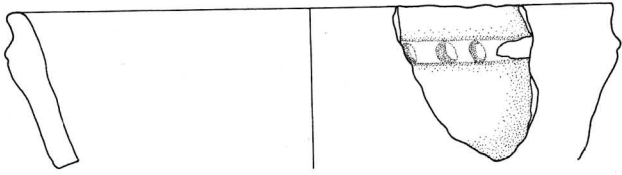

7

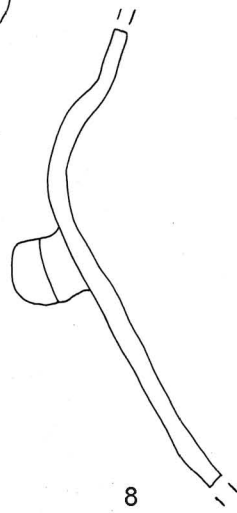

8

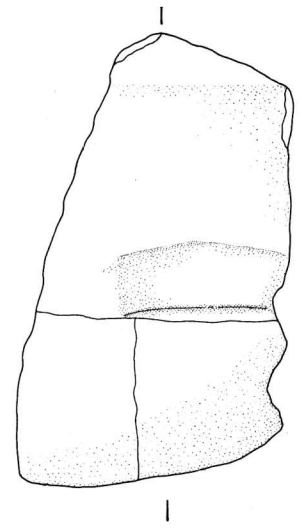

9

Tav. 146 - Santa Rosa di Poviglio: materiali ceramici provenienti dalle strutture del centro fossato; 1, 2) da US 6142; 3-8) da US 6155 (scala 1:3).

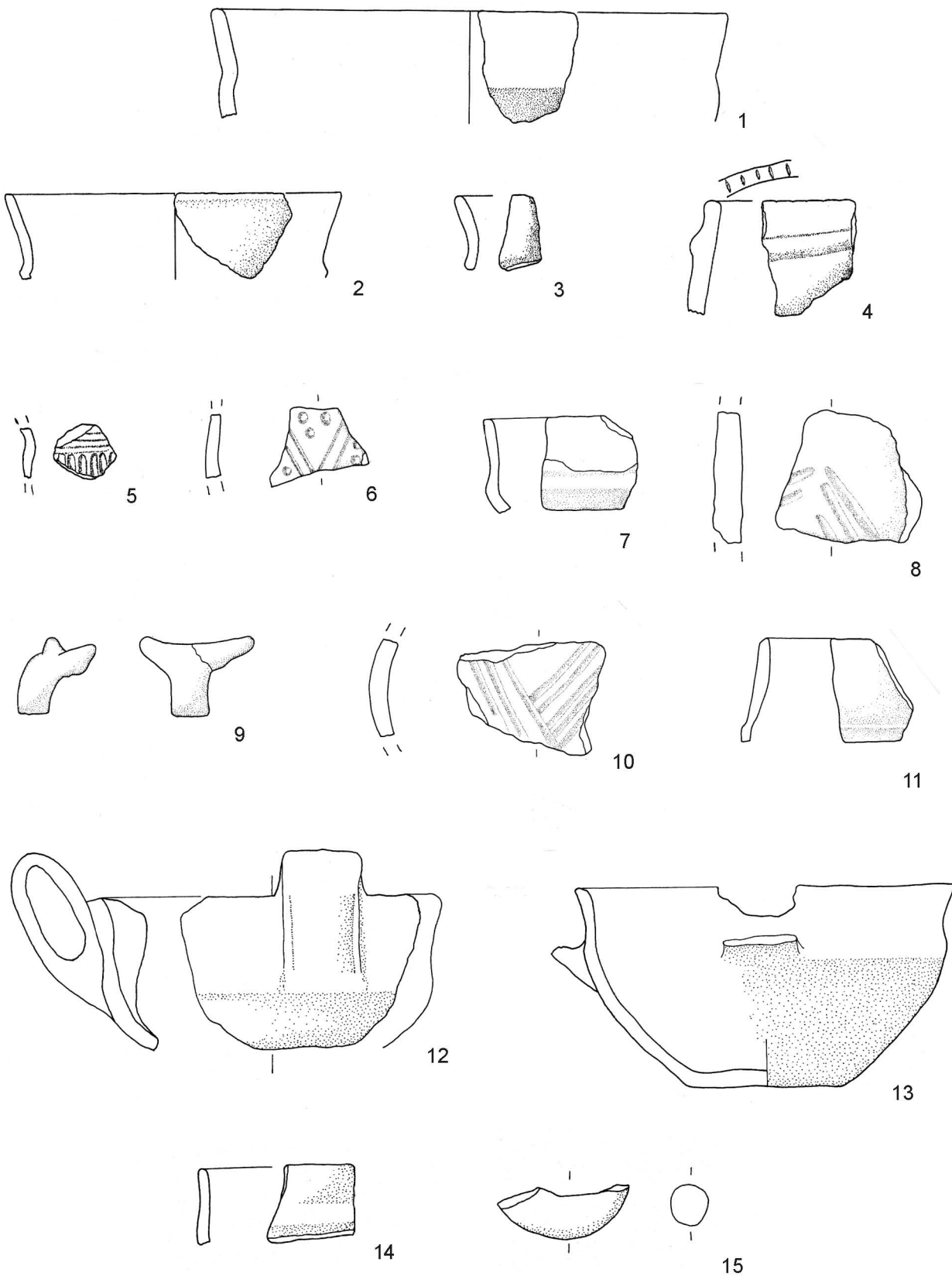

Tav. 147 - Santa Rosa di Poviglio: materiali ceramici provenienti dall'area della campagna interna. 1, 2) da US 6141; 3, 4) da US 6140; 5) da US 6134; 6) da US 6199; 7, 8) da US 6217; 9) da US 6205; 10) da US 6260; 11) da US 6235; 12) da US 6473; 13-15) da US 6350 (scala 1:3).

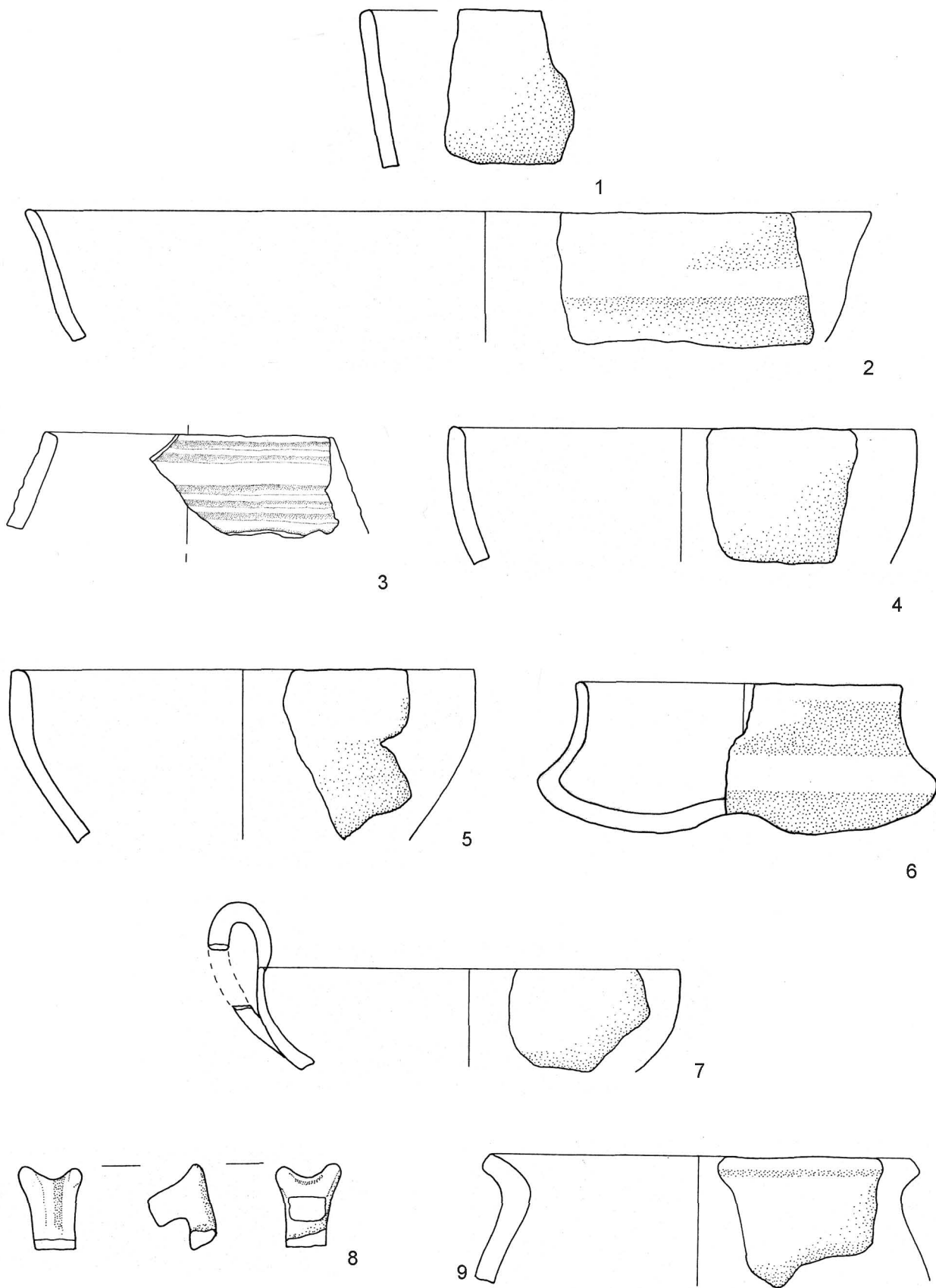

Tav. 148 - Santa Rosa di Poviglio: materiali ceramici provenienti dall'area della campagna interna; 1) da US 6290; 2) da US 6289; 3) da US 6264; 4) da US 6378; 5) da US 6402; 6) da US 6397; 7) da US 6366; 8, 9) da US 6355 (scala 1:3).

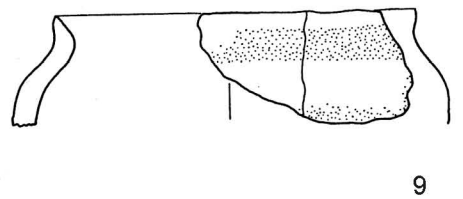
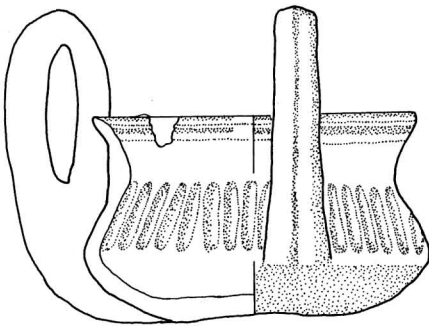
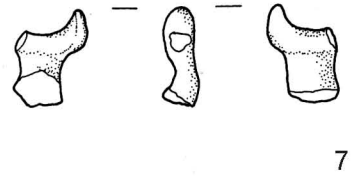
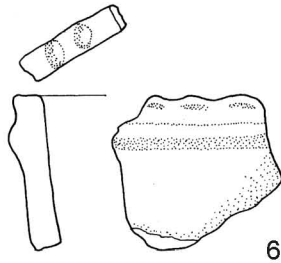
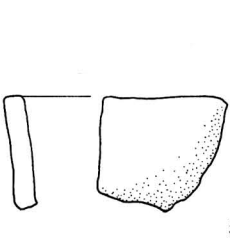
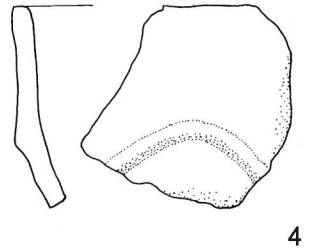
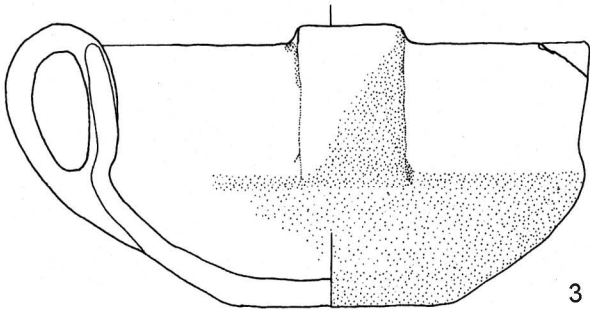
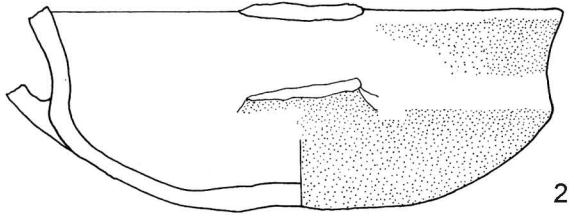
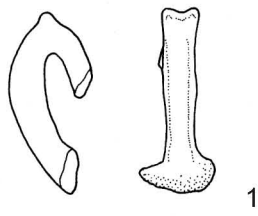

Tav. 149 - Santa Rosa di Poviglio: materiali ceramici provenienti dall'area tra le due risalite; 1) da US 6463; 2) da US 6468; 3) da US 6482; 4) da US 6500; 5, 6) da US 6509; 7) da US 6529; 8, 9) da US 6642 (scala 1:3).

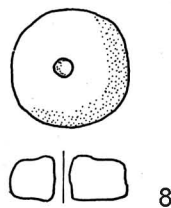
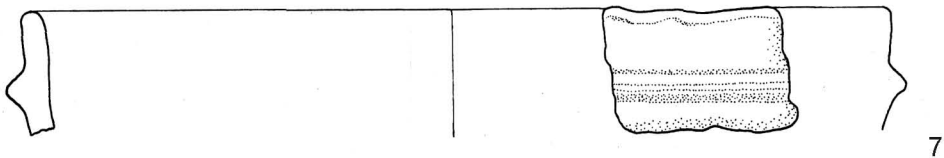
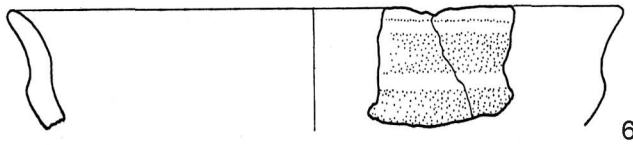
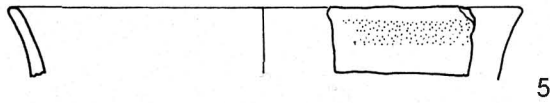
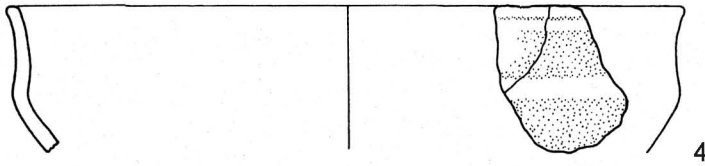
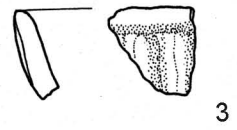
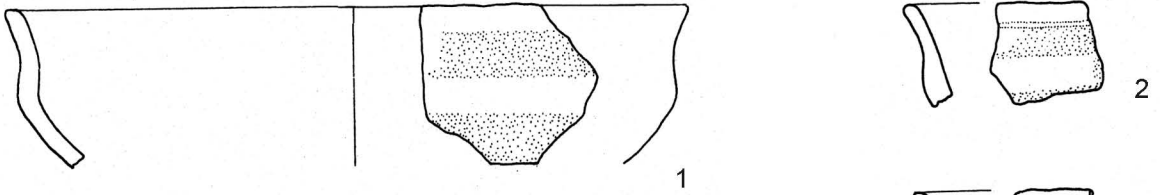

Tav. 150 - Santa Rosa di Poviglio: materiali ceramici e fittili provenienti dal canale adduttore; 1-3) da US 6571, 4-5) da US 6568, 6-7) da US 6483, 8) da US 6483a (1-7 scala 1:3; 8 scala 1:2).

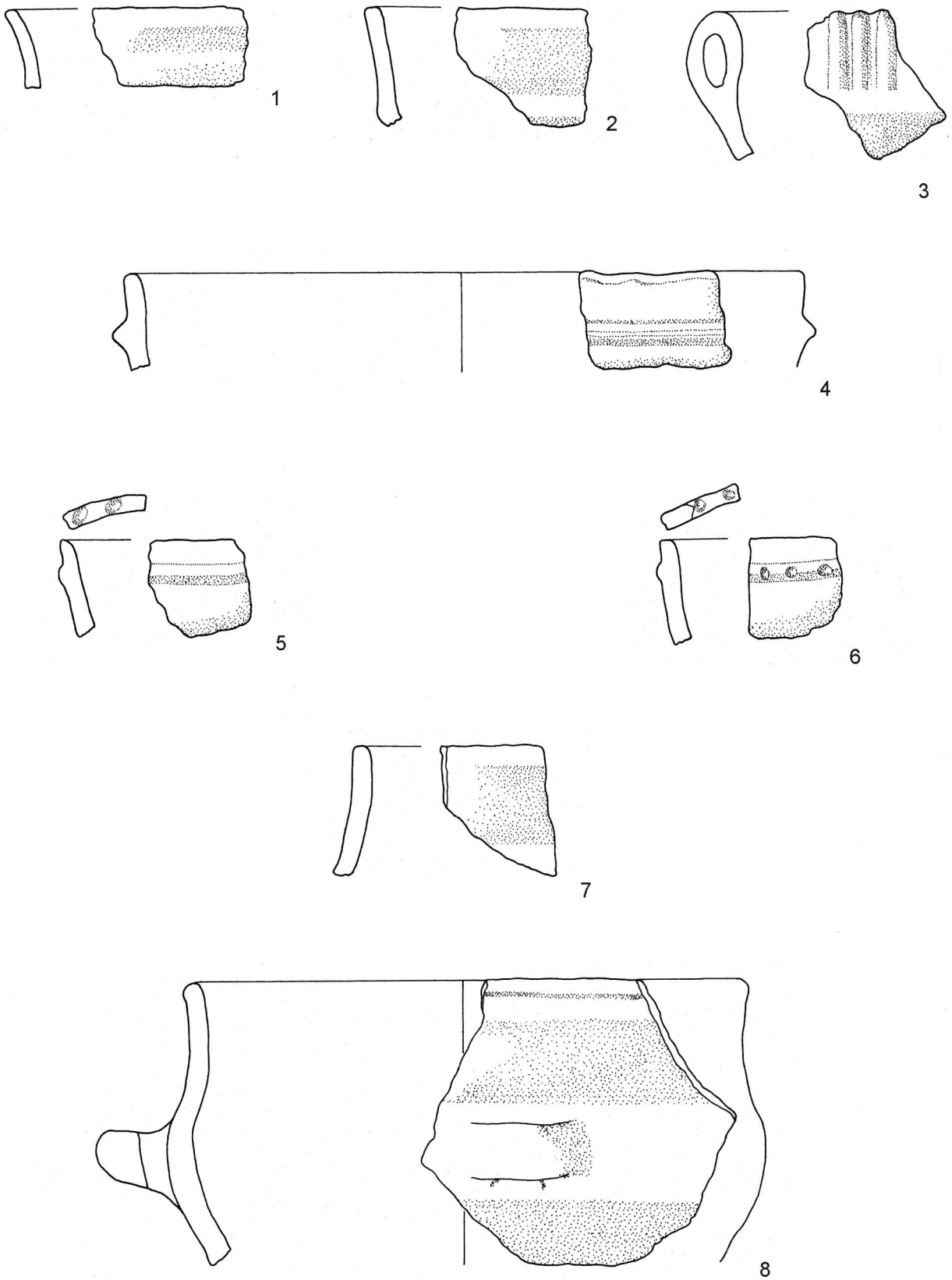

Tav. 151 - Santa Rosa di Poviglio: materiali ceramici provenienti dal canale adduttore; 1-8) da US 6477, AB-AAT 177-199 (scala 1:3).

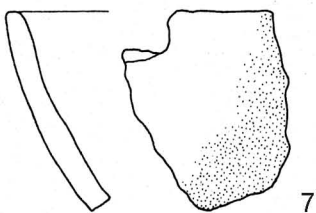
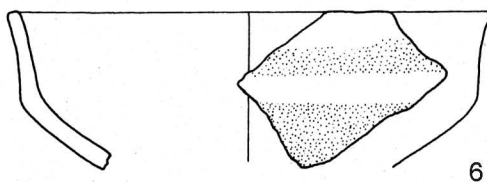
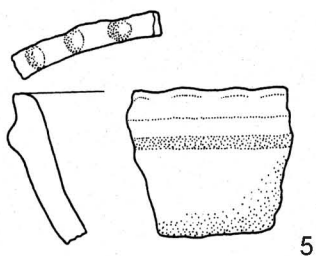
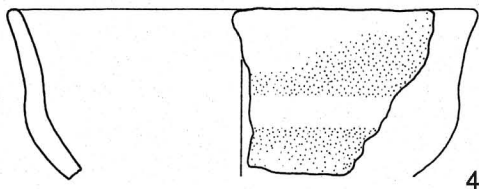
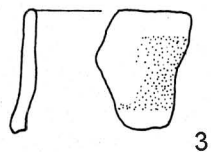
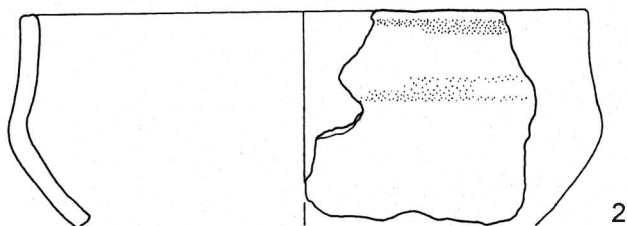
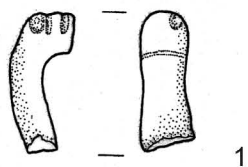

Tav. 152 - Santa Rosa di Poviglio: materiali ceramici provenienti dal canale adduttore;
1-4) da US 6477, AA-AE 190-193; 5) da US 6477, AA-AE 193-195; 6) da US 6477,
AD-AI 193-197; 7) da US 6477, AB-AE 194-196 (scala 1:3).

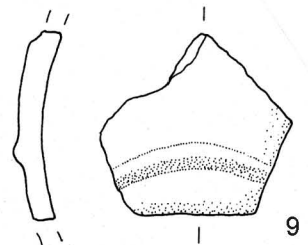
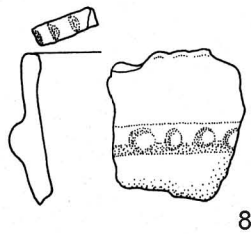
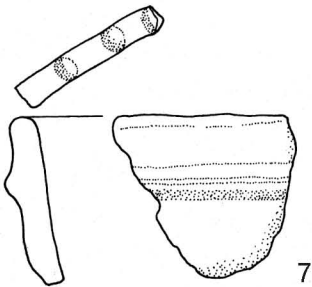
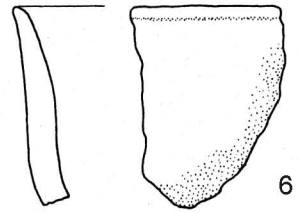
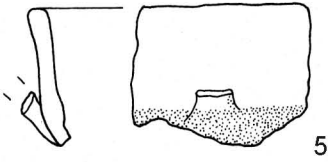
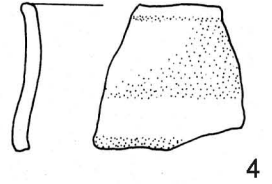
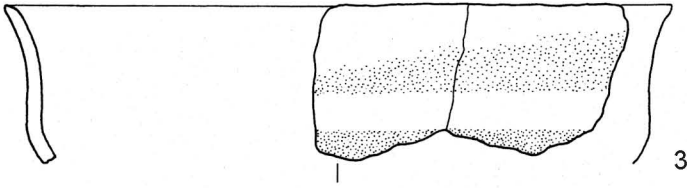
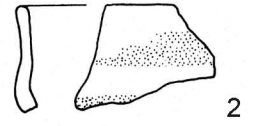
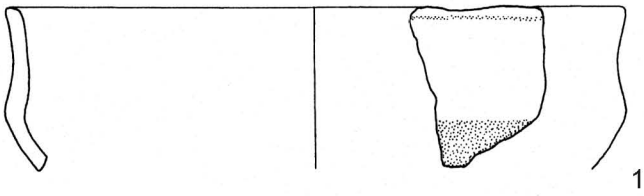

Tav. 153 - Santa Rosa di Poviglio: materiali ceramici provenienti dal canale adduttore; 1-9) da US 6484 (scala 1:3).

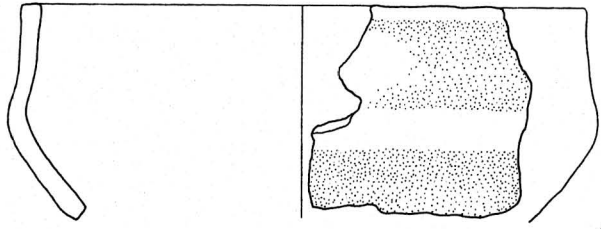

1

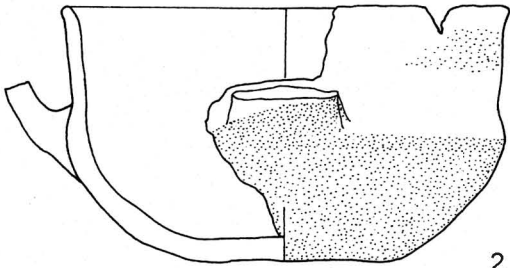

2

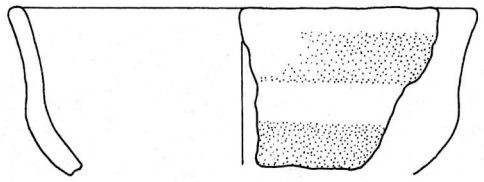

3

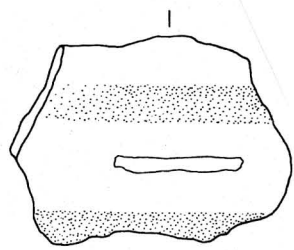

4

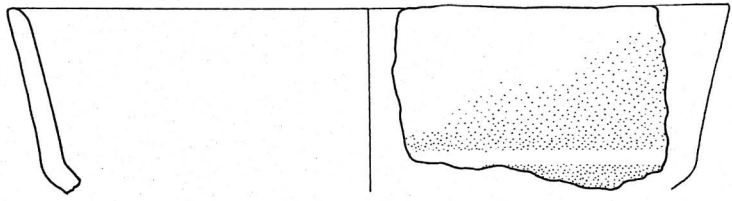

5

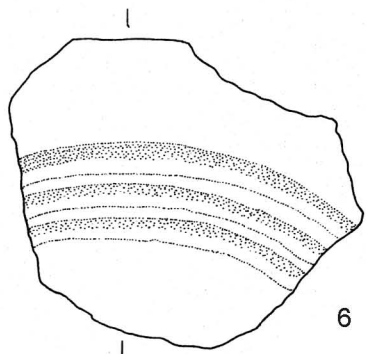

6

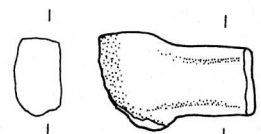

7

Tav. 154 - Santa Rosa di Poviglio: materiali ceramici provenienti dall'area del canale adduttore; 1-7) da US 6506 (scala 1:3).

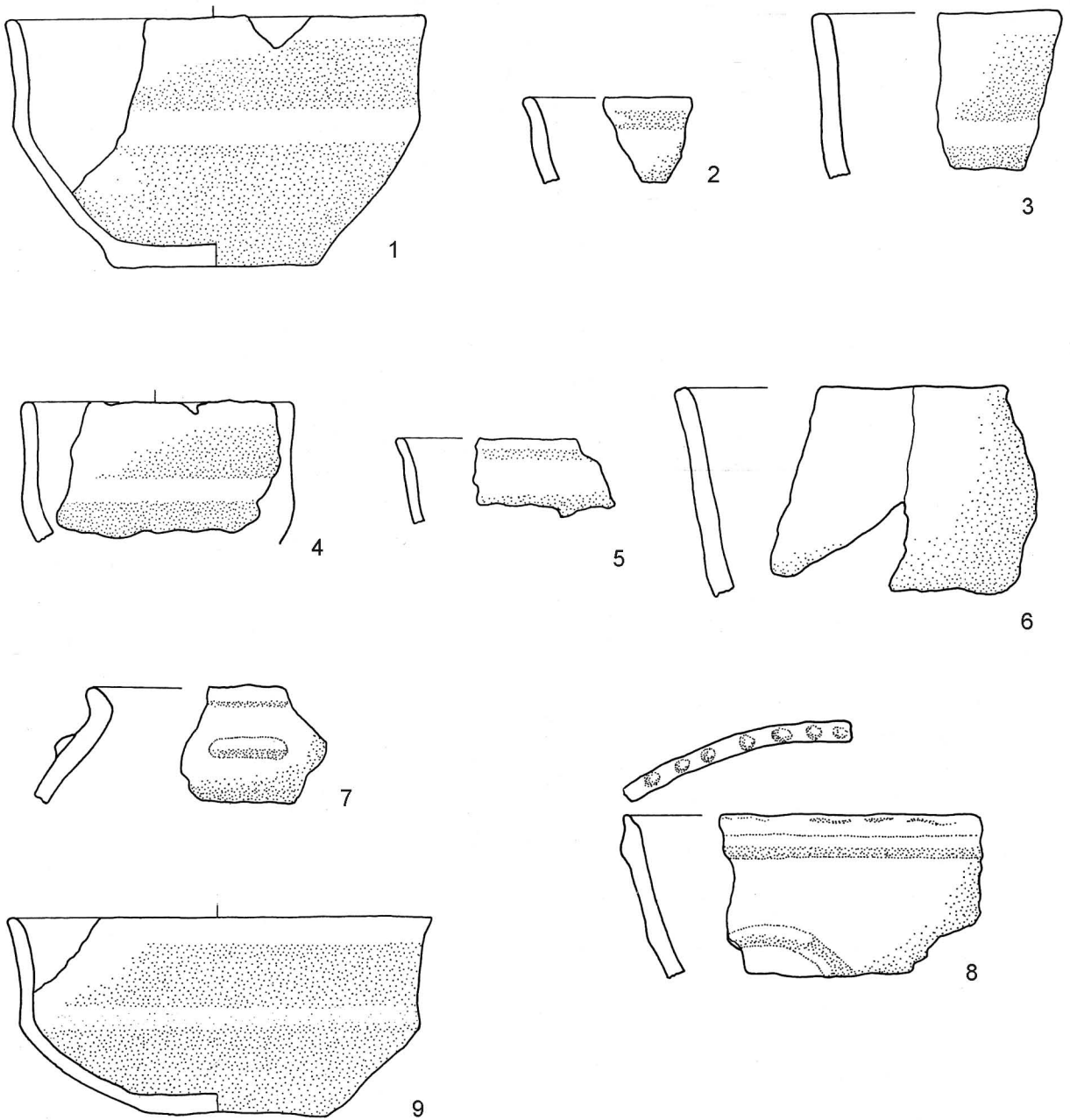

Tav. 155 - Santa Rosa di Poviglio: materiali ceramici provenienti dall'area della campagna esterna; 1-3) da US 6672; 4-7) da US 6653; 8) da US 6682; 9) da US 6682+6669 (scala 1:3).

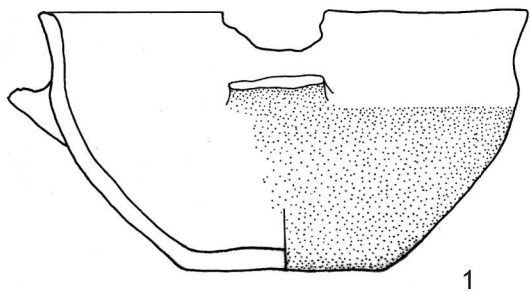

1

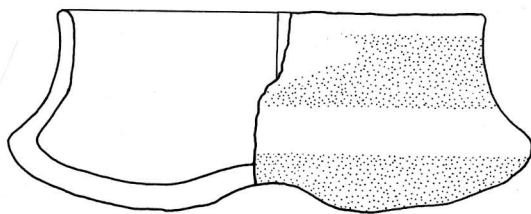

2

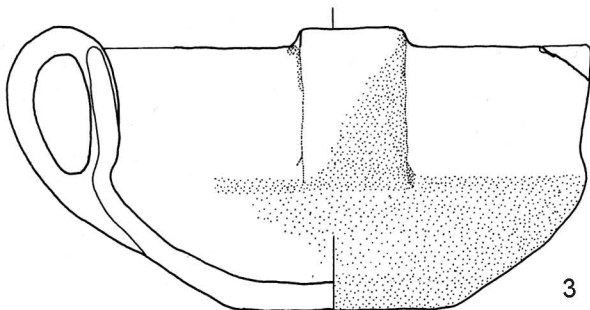

3

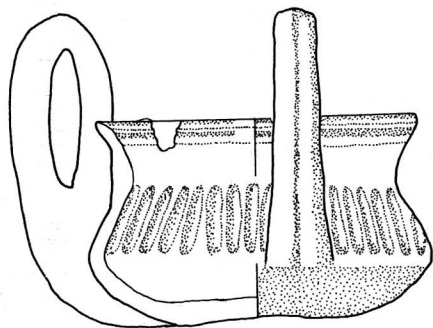

4

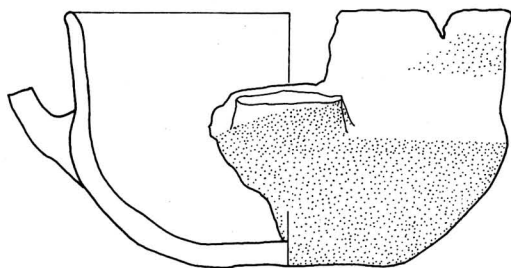

5

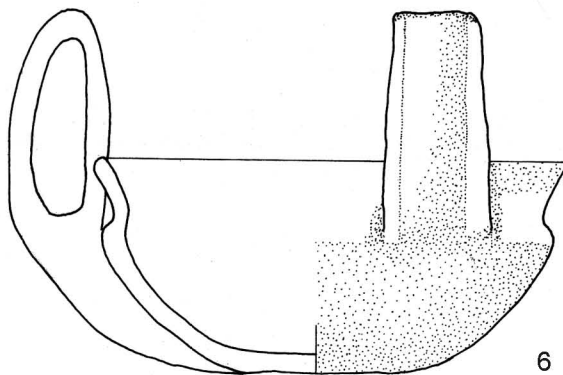

6

Tav. 156 - Santa Rosa di Poviglio: vasi interi provenienti dai pozzi dell'area esterna all'abitato; 1) da US 6350; 2) da US 6397; 3) da US 6482; 4) da US 6642; 5) da US 6506; 6) da US 6780 (scala 1:3).

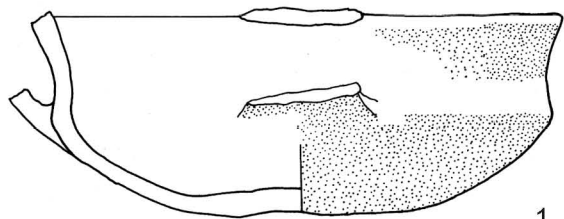

1

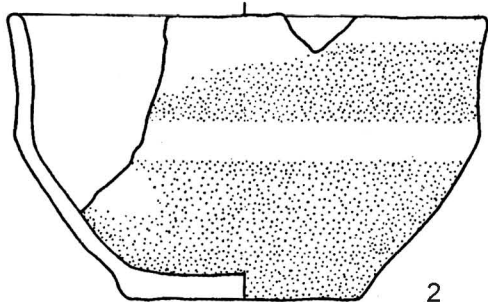

2

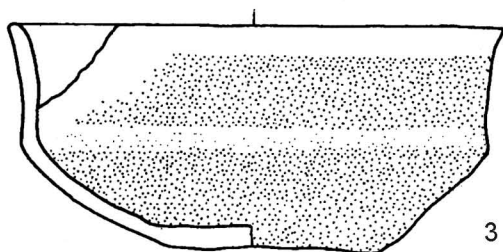

3

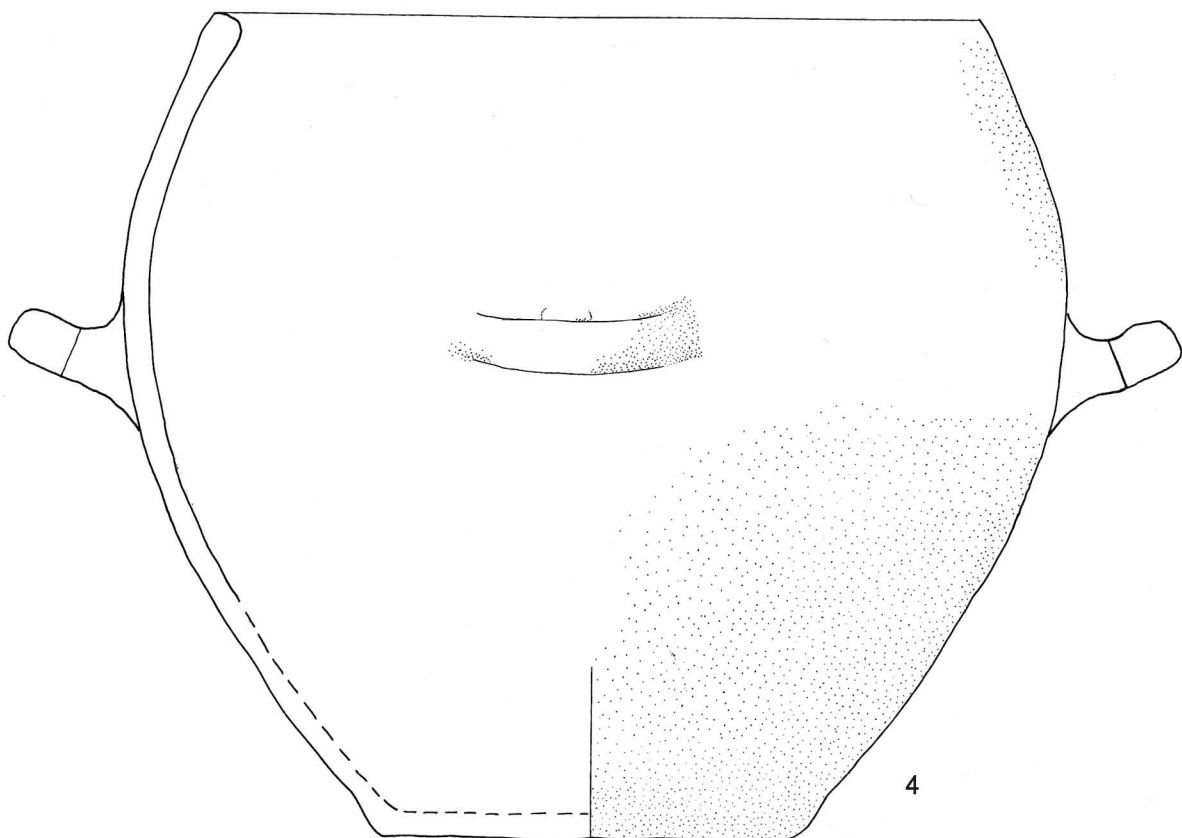

4

Tav. 157 - Santa Rosa di Poviglio: vasi interi provenienti dalle strutture dell'area esterna all'abitato; 1) da US 6469; 2) da US 6672; 3) da US 6682+6669; 4) da US 6759 (scala 1:3).

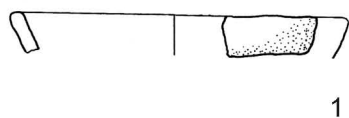

1

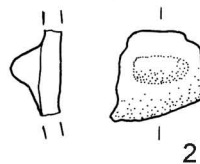

2

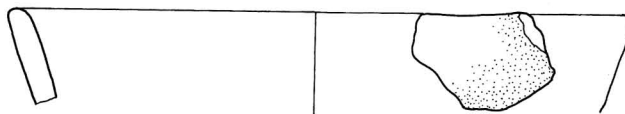

3

Tav. 158a - Case Cocconi: materiali ceramici provenienti dalle indagini effettuate (scala 1:3).

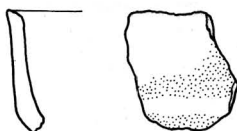

1

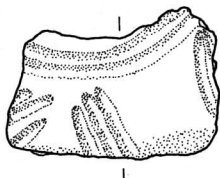

2

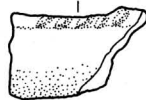

4

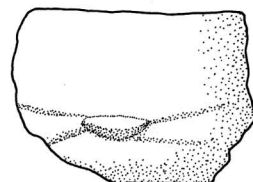
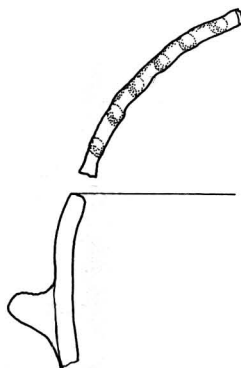

5

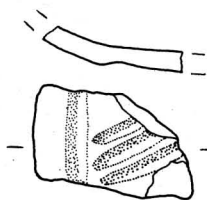

3



6

Tav. 158b - Buco del Signore: materiali ceramici provenienti dal sondaggio 2002 (scala 1:3).

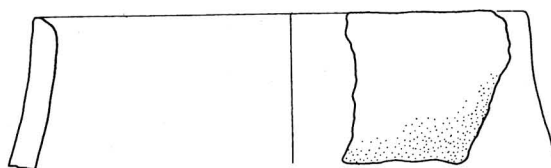
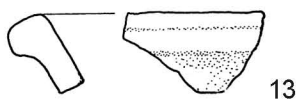
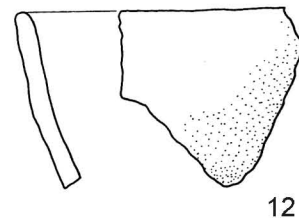
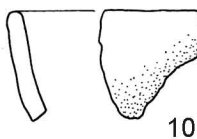
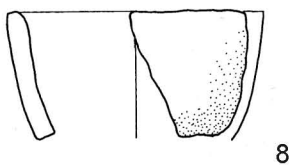
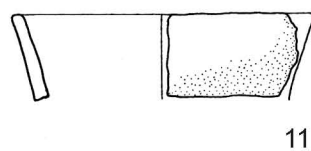
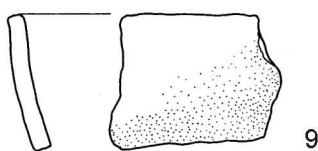
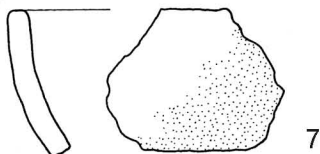
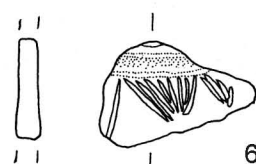
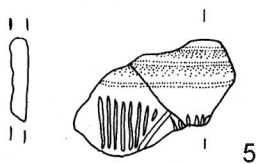
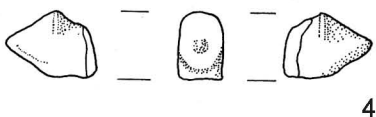
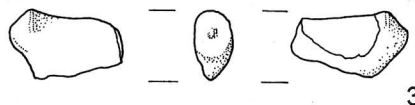
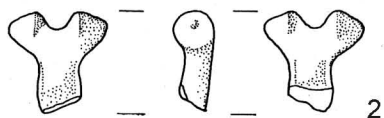
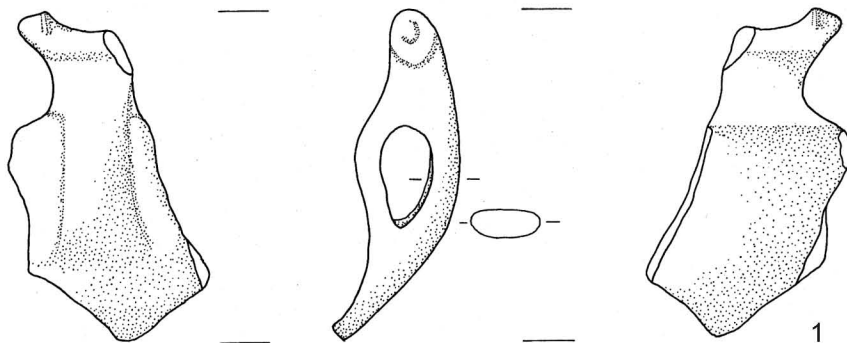

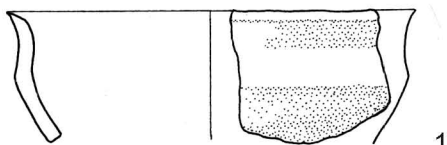

1

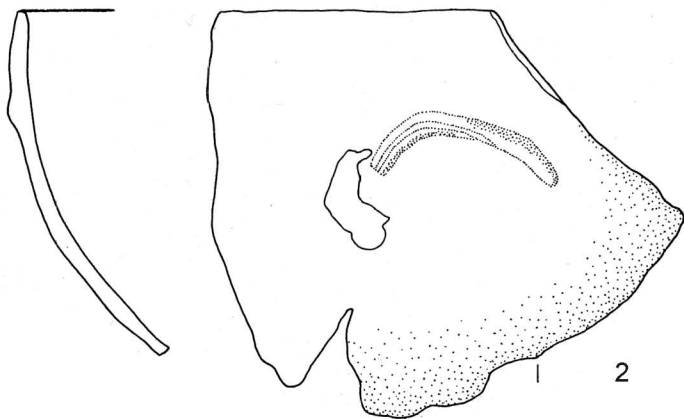

2

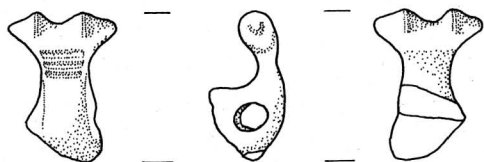

3

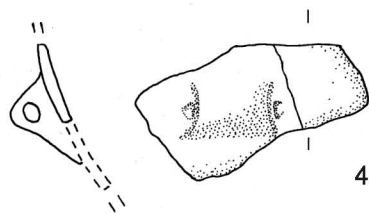

4



5

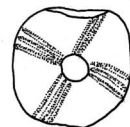

6

Tav. 160 - Buco del Signore: materiali provenienti dal sondaggio 2006; 1, 2, 5) da US 69; 3, 4) da US 70; 6) da US 57 (1-4 scala 1:3; 5, 6 scala 1:2).

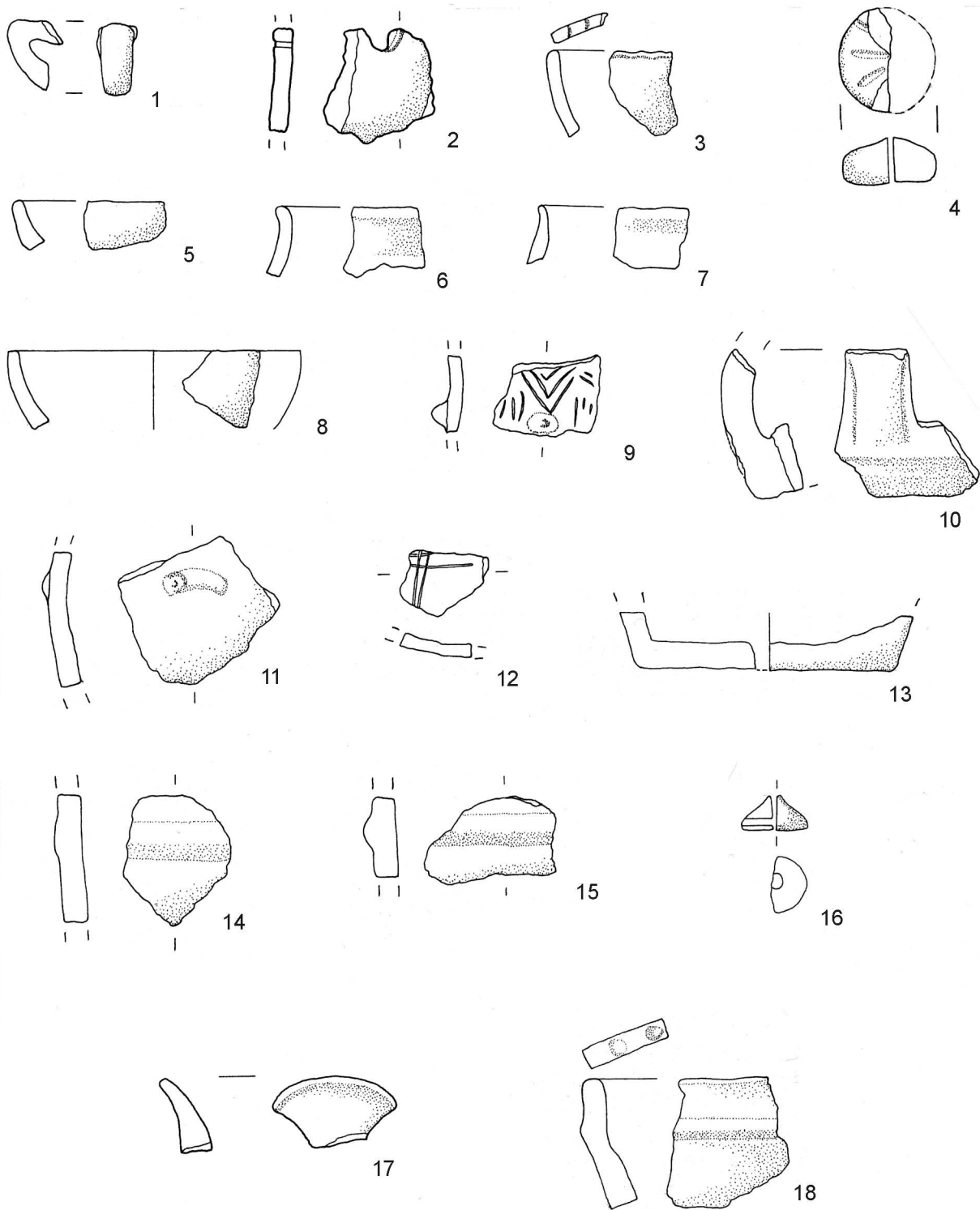

Tav. 161 - Cortile S. Martino: materiali ceramici, fittili e in pasta vitrea; 1) da US 68; 2) da US 174; 3) da US 133; 4) da US 98; 5) da US 298; 6) da US 221; 7-16) da US 190; 17-18) da US 191 (1-3, 5-15 scala 1:3; 4, 16 scala 1:2).

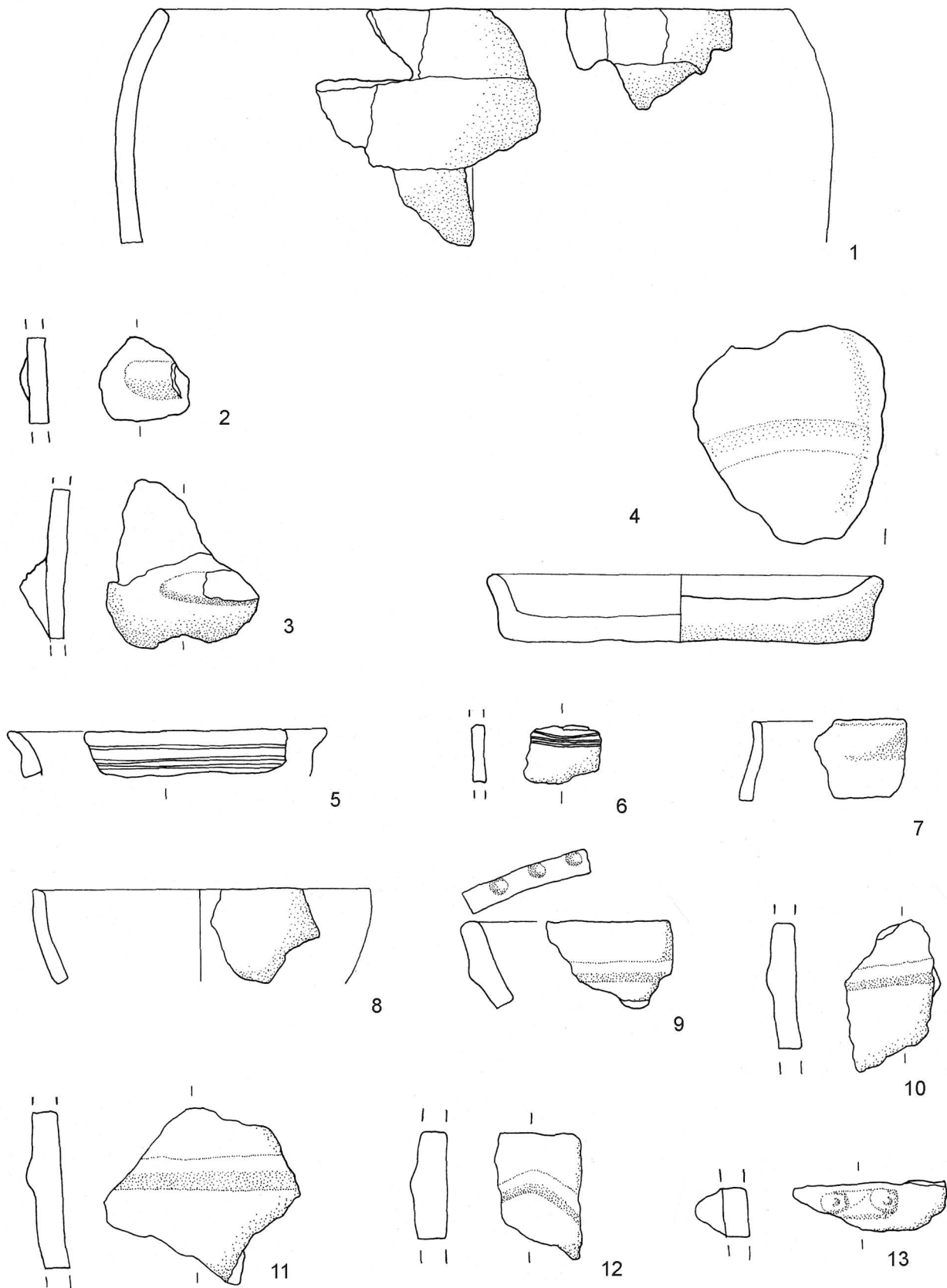

Tav. 162 - Cortile S. Martino: materiali ceramici; 1-3) da US 192; 4) da US 112; 5-13) da US 114 (scala 1:3).

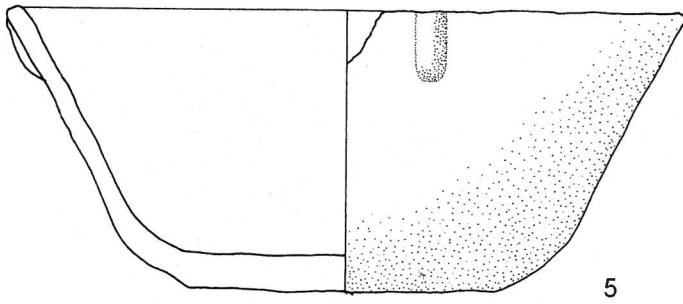
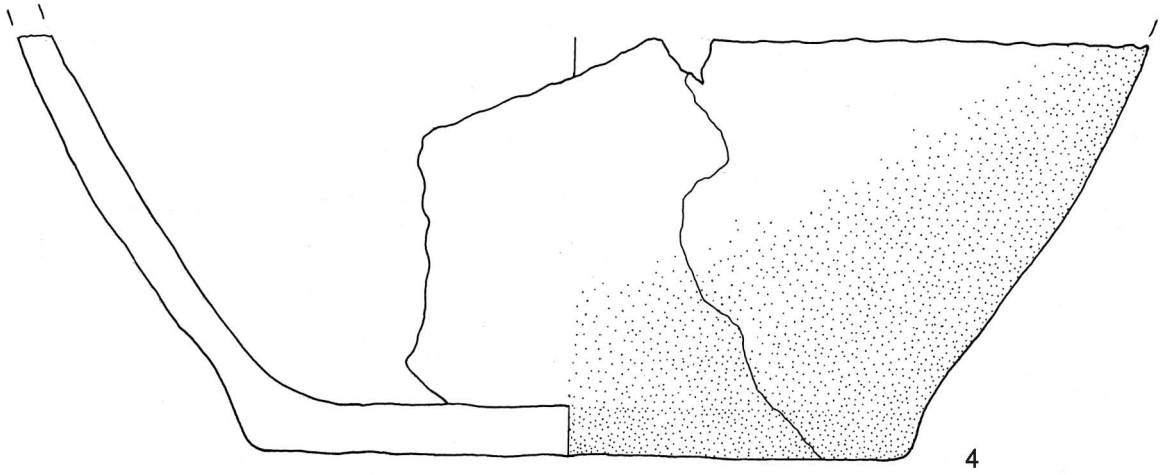
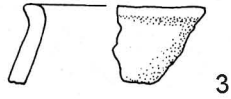
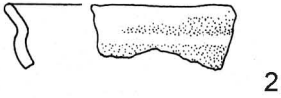
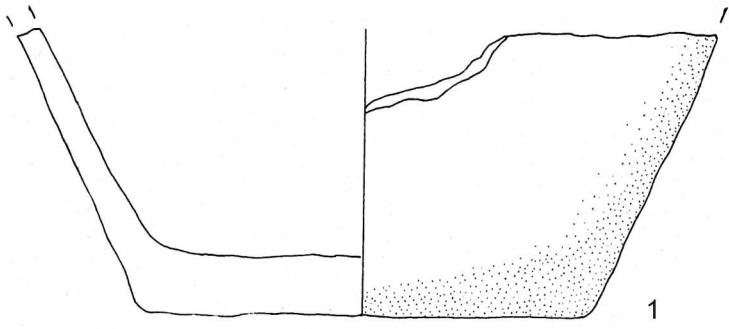

Tav. 163 - Cortile S. Martino: materiali ceramici; 1) da US 83; 2, 3) da US 85; 4) da US 101; 5) da US 77 (scala 1:3).

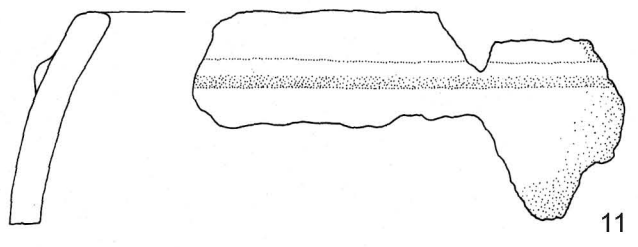
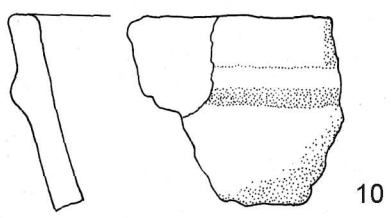
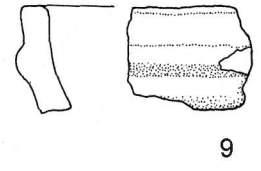
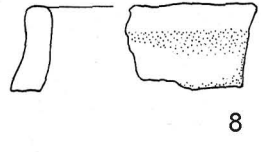
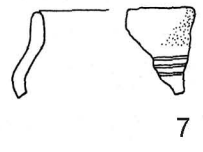
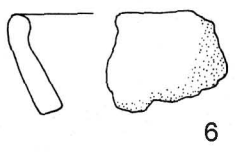
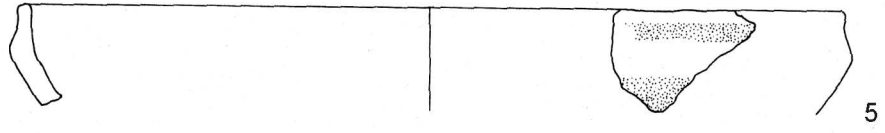
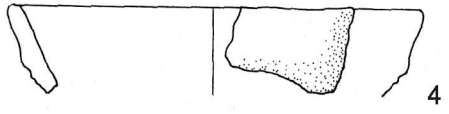
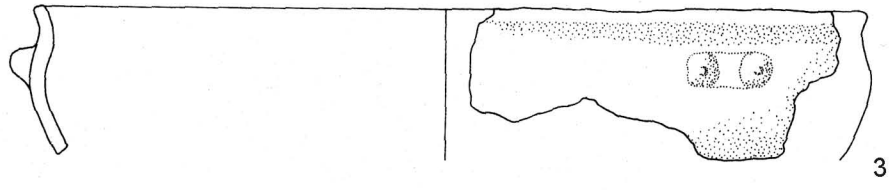
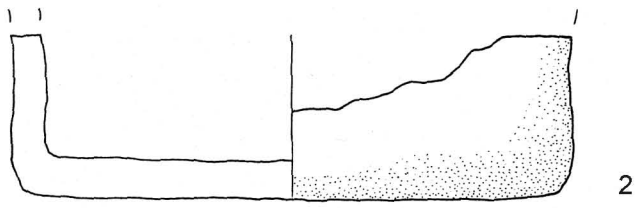
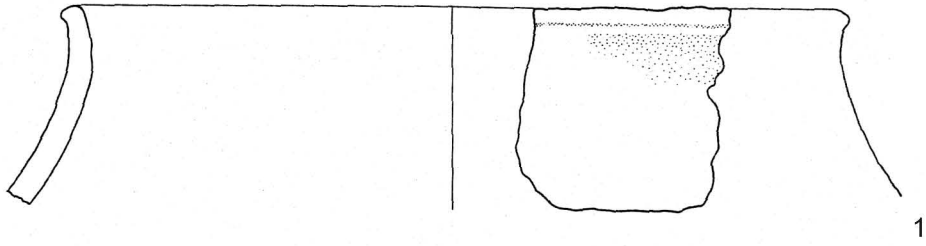

Tav. 164 - Cortile S. Martino: materiali ceramici; 1, 2) da US 116; 3, 4) da US 214; 5-11) da US 104 (scala 1:3).

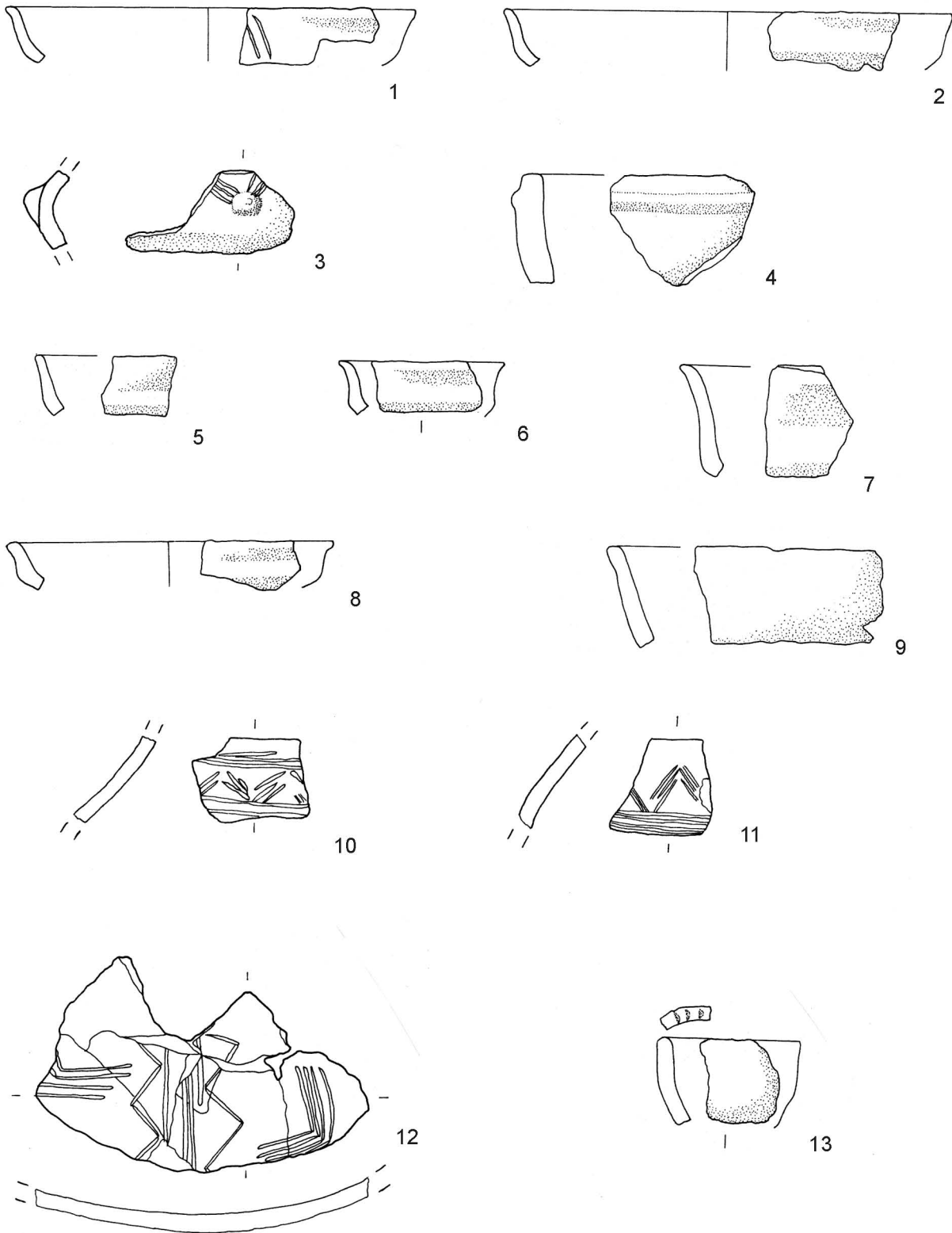

Tav. 165 - Cortile S. Martino: materiali ceramici; 1-4) da US 105; 5-13) da US 73 (scala 1:3).

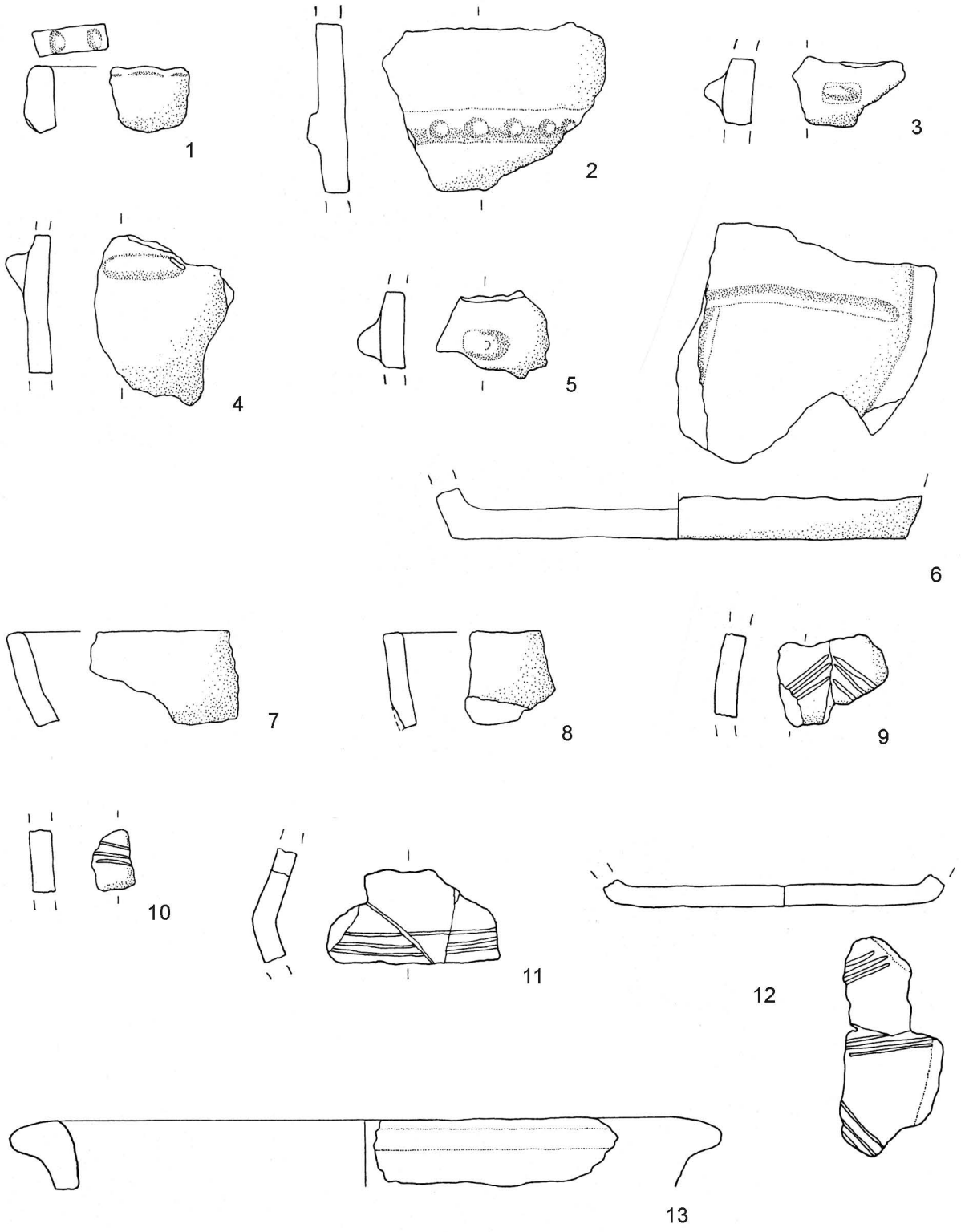

Tav. 166 - Cortile S. Martino: materiali ceramici; 1-6) da US 73; 7-13) da US 74 (scala 1:3).

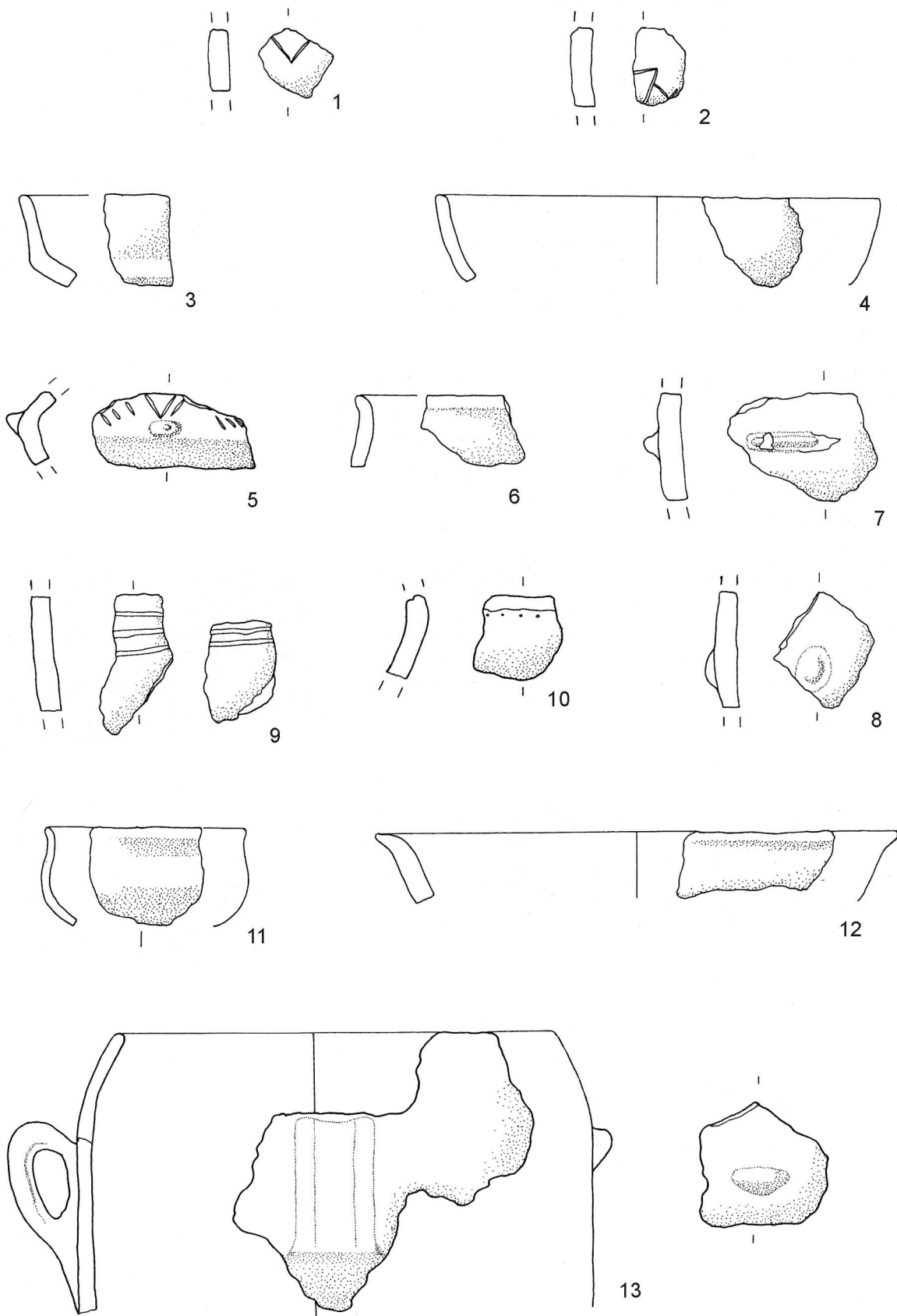

Tav. 167 - Cortile S. Martino: materiali ceramici; 1, 2) da US 61; 3-8) da US 39; 9, 10) da US 40; 11) da US 533; 12) da US 110; 13) da US 367 (scala 1:3).

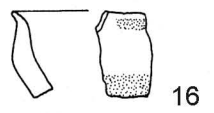
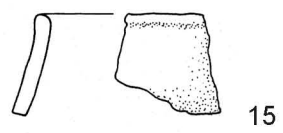
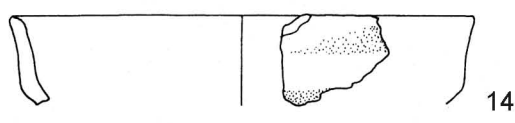
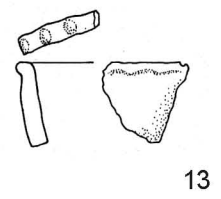
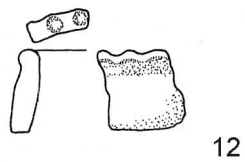
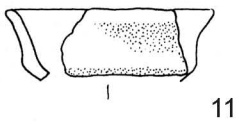
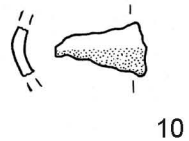
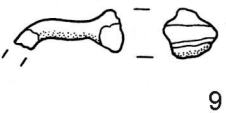
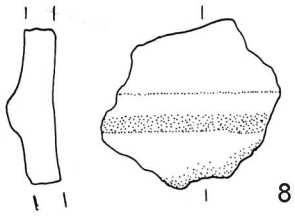
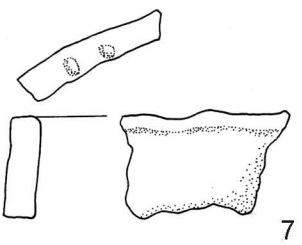
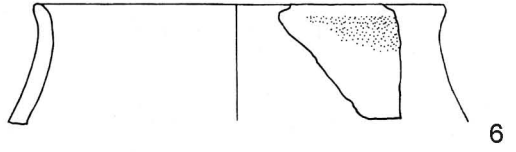
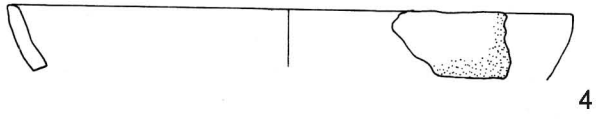
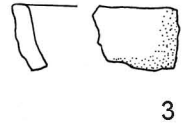
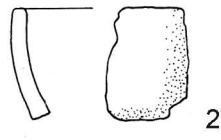
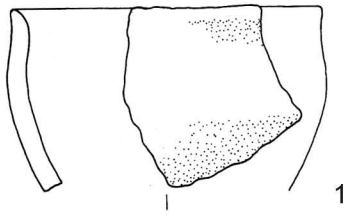

Tav. 168 - Cortile S. Martino: materiali ceramici; 1-8) da US 38; 9, 10) da US 619; 11) da US 157; 12, 13) da US 282; 14, 15) da US 368; 16) da US 385 (scala 1:3).

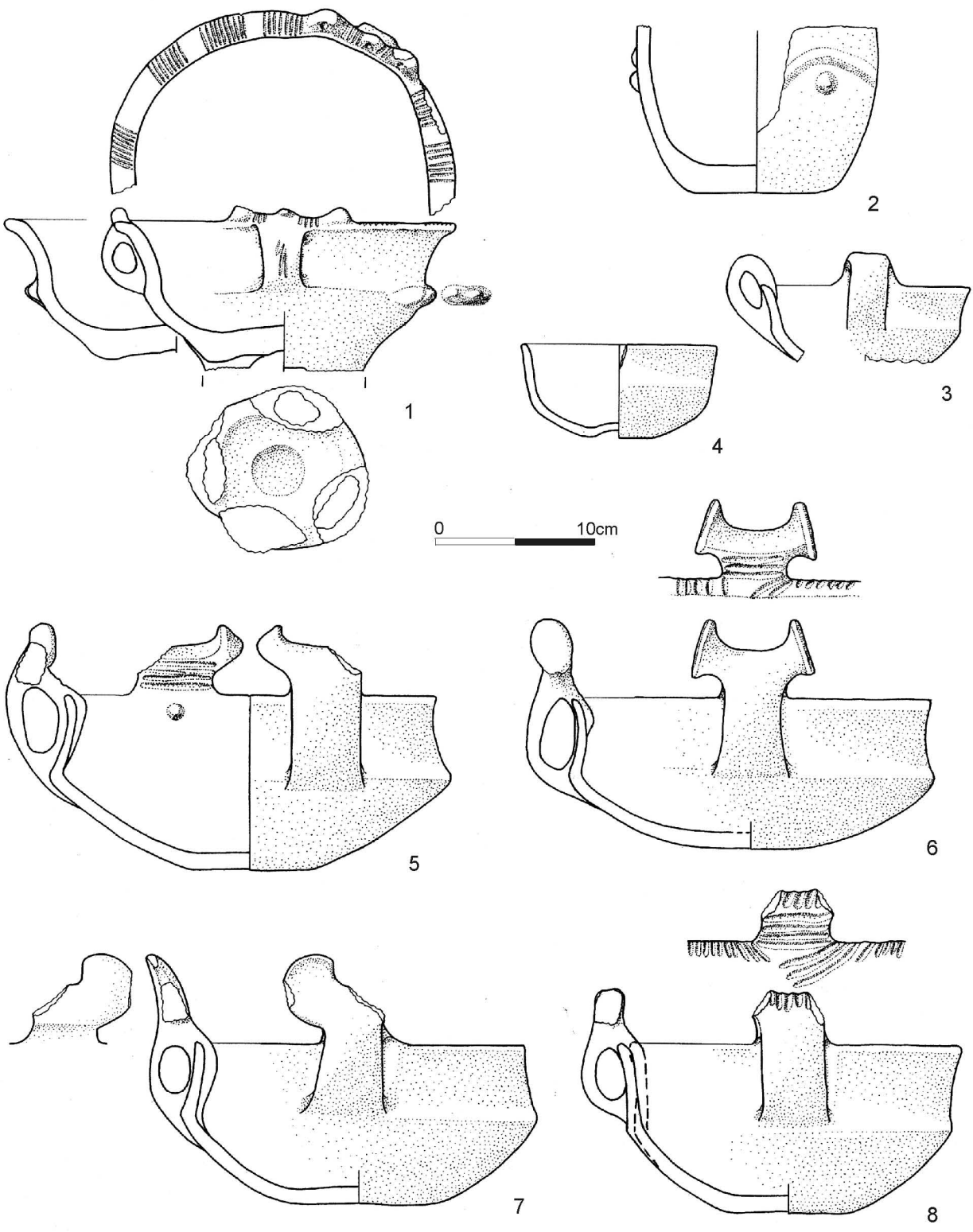

Tav. 169 - Noceto La Torretta: recipienti ceramici interi; 1, 3) da US 89; 2) da US 90; 4) da US 87; 5-8) da US 87a (da Mutti, Pizzi 2009).

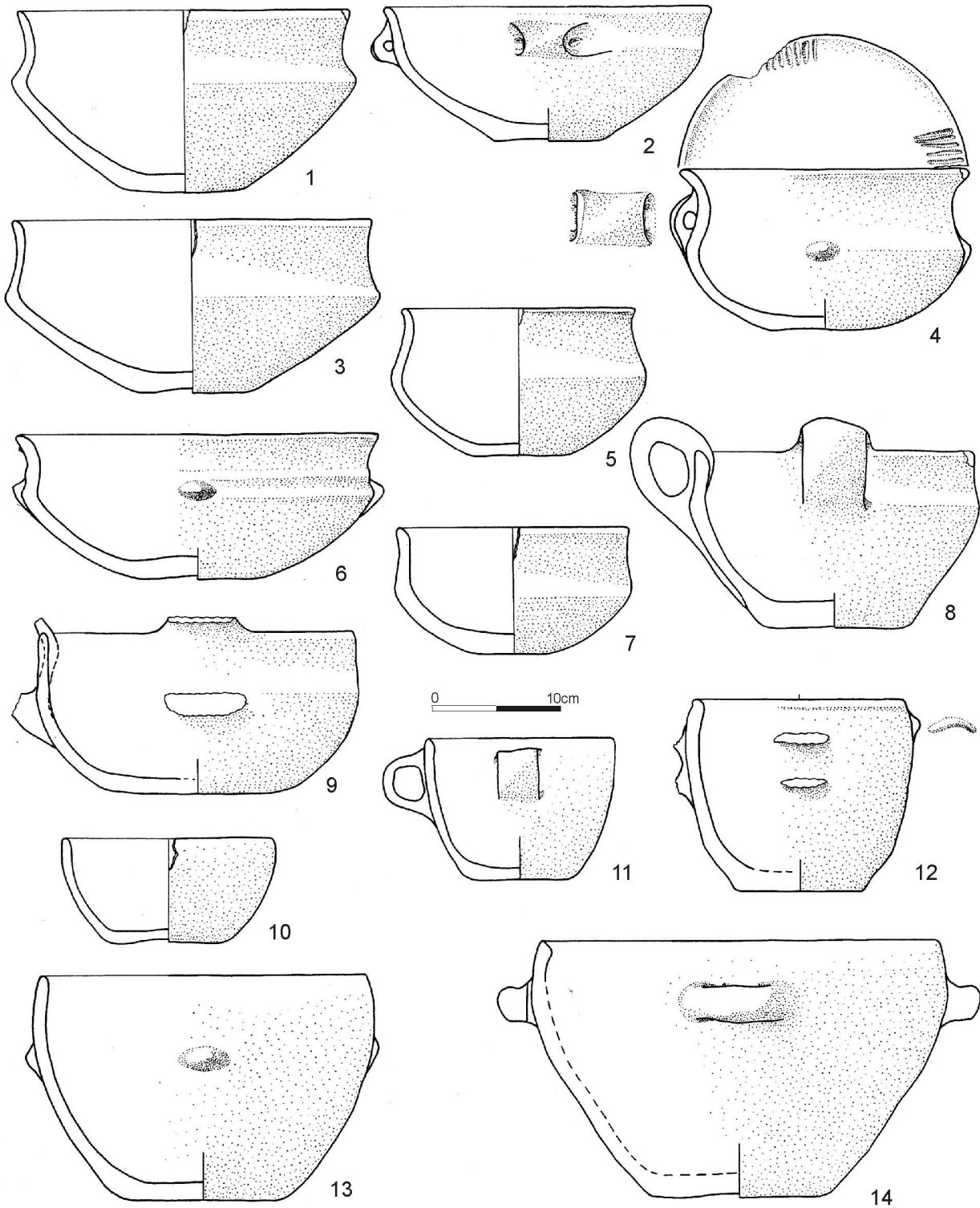

Tav. 170 - Noceto La Torretta: recipienti ceramici interi; 1-14) da US 87a (da Mutti, Pizzi 2009).

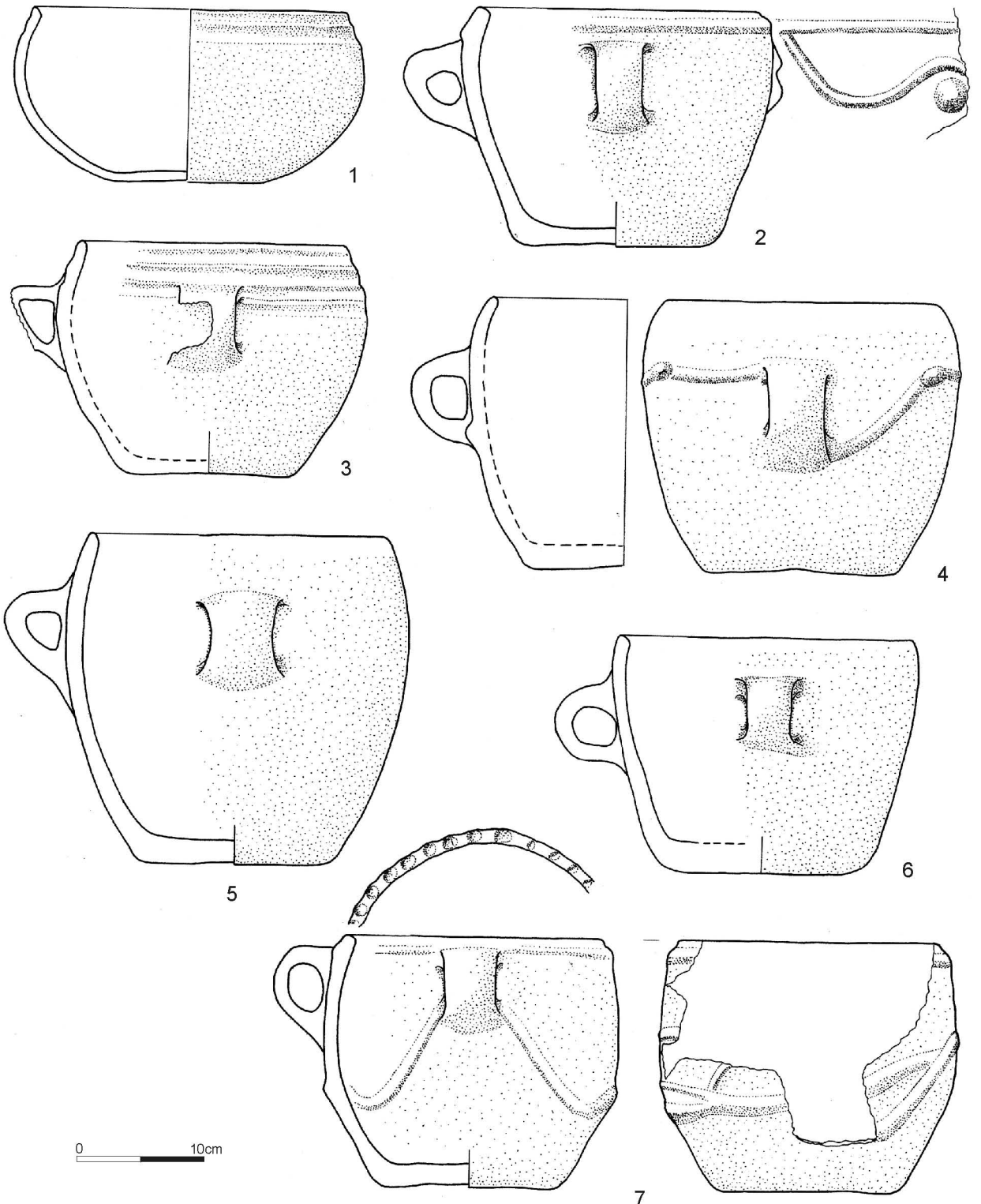

Tav. 171 - Noceto La Torretta: recipienti ceramici interi; 1-7) da US 87a (da Mutti, Pizzi 2009).

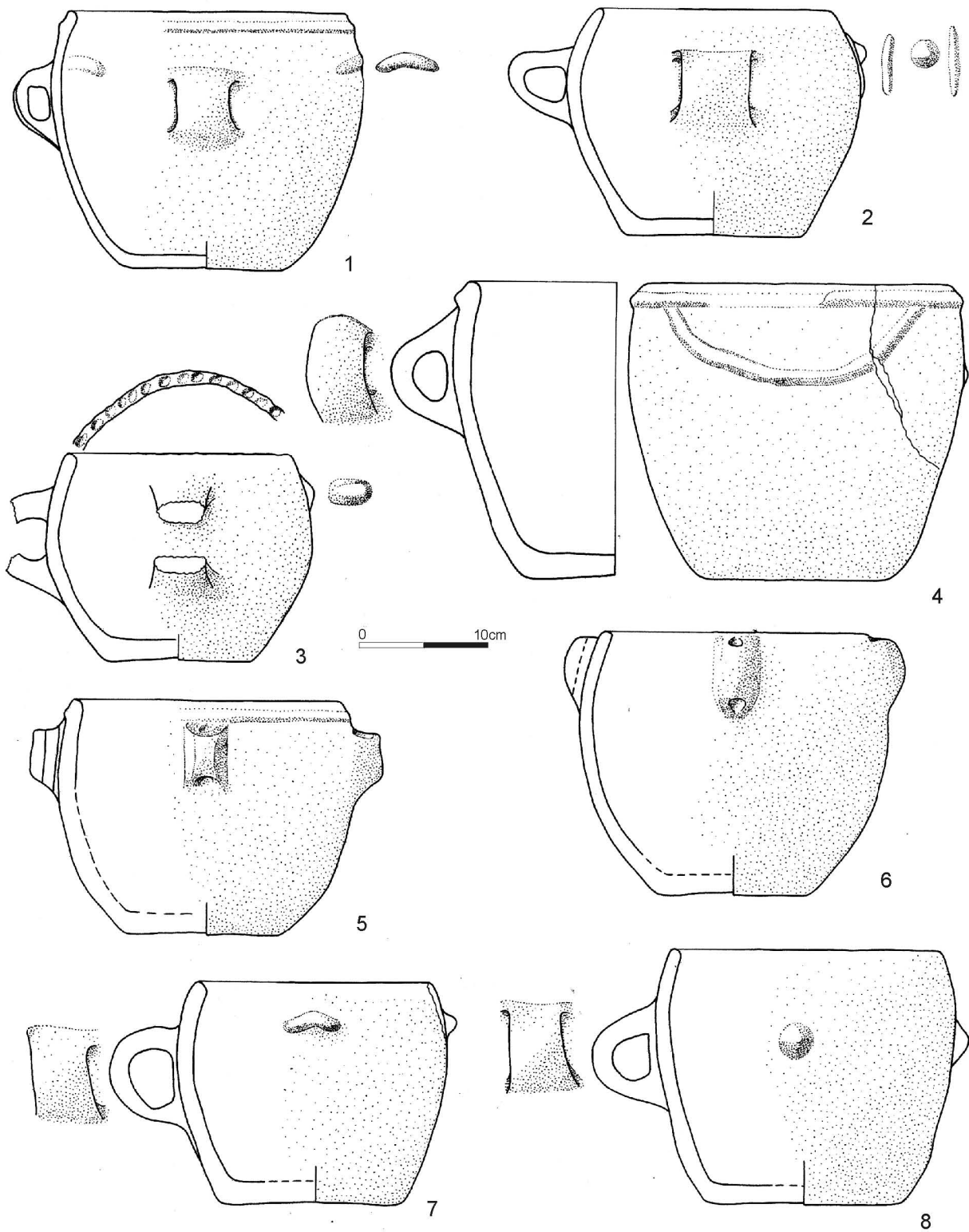

Tav. 172 - Noceto La Torretta: recipienti ceramici interi; 1-8) da US 87a (da Mutti, Pizzi 2009).

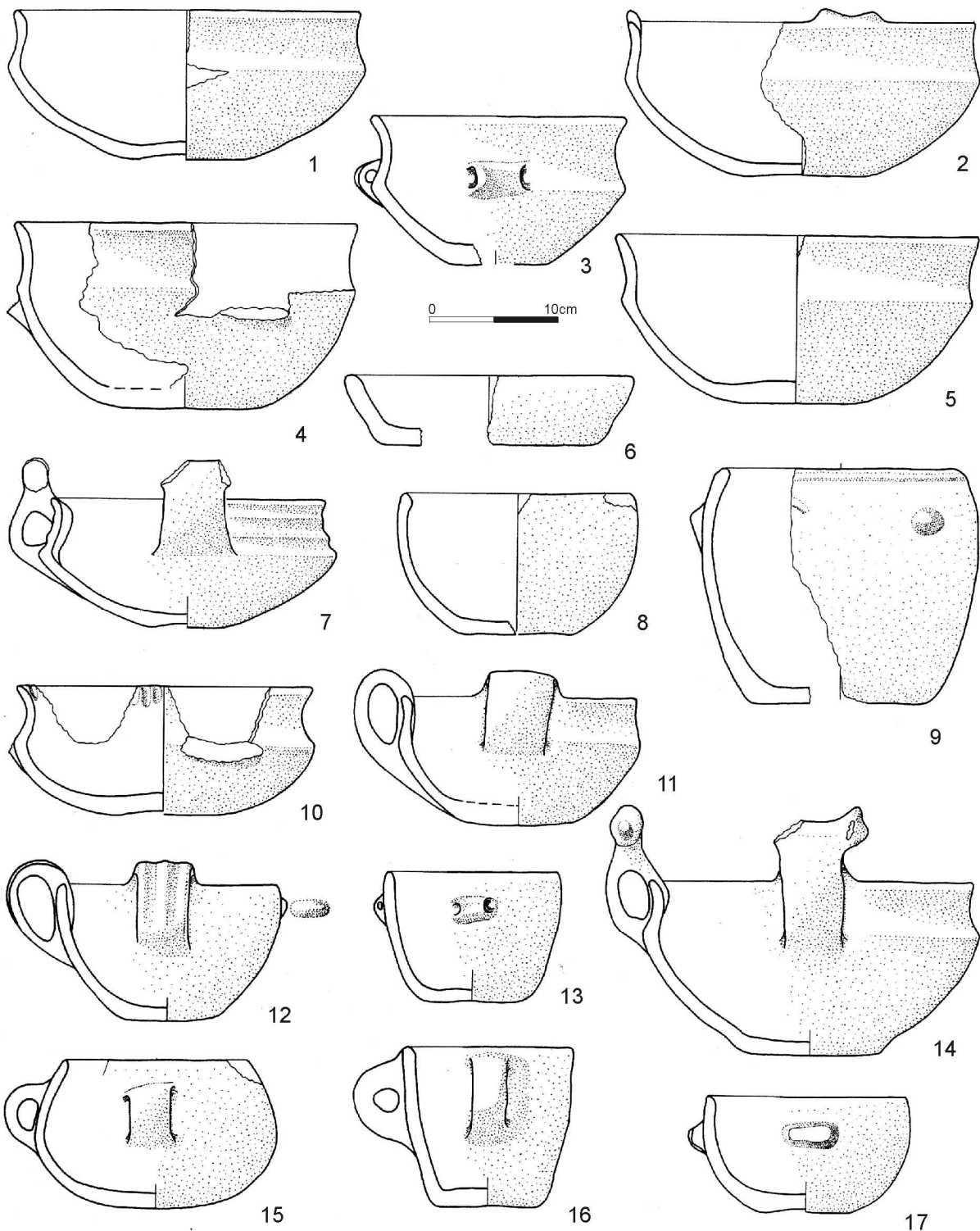

Tav. 173 - Noceto La Torretta: recipienti ceramici interi; 1, 2, 4, 5) da US 84; 3) da US 85; 6-9) da US 82; 10-17) da UUSS 81, "sotto 81c", 81d-e (da Mutti, Pizzi 2009).

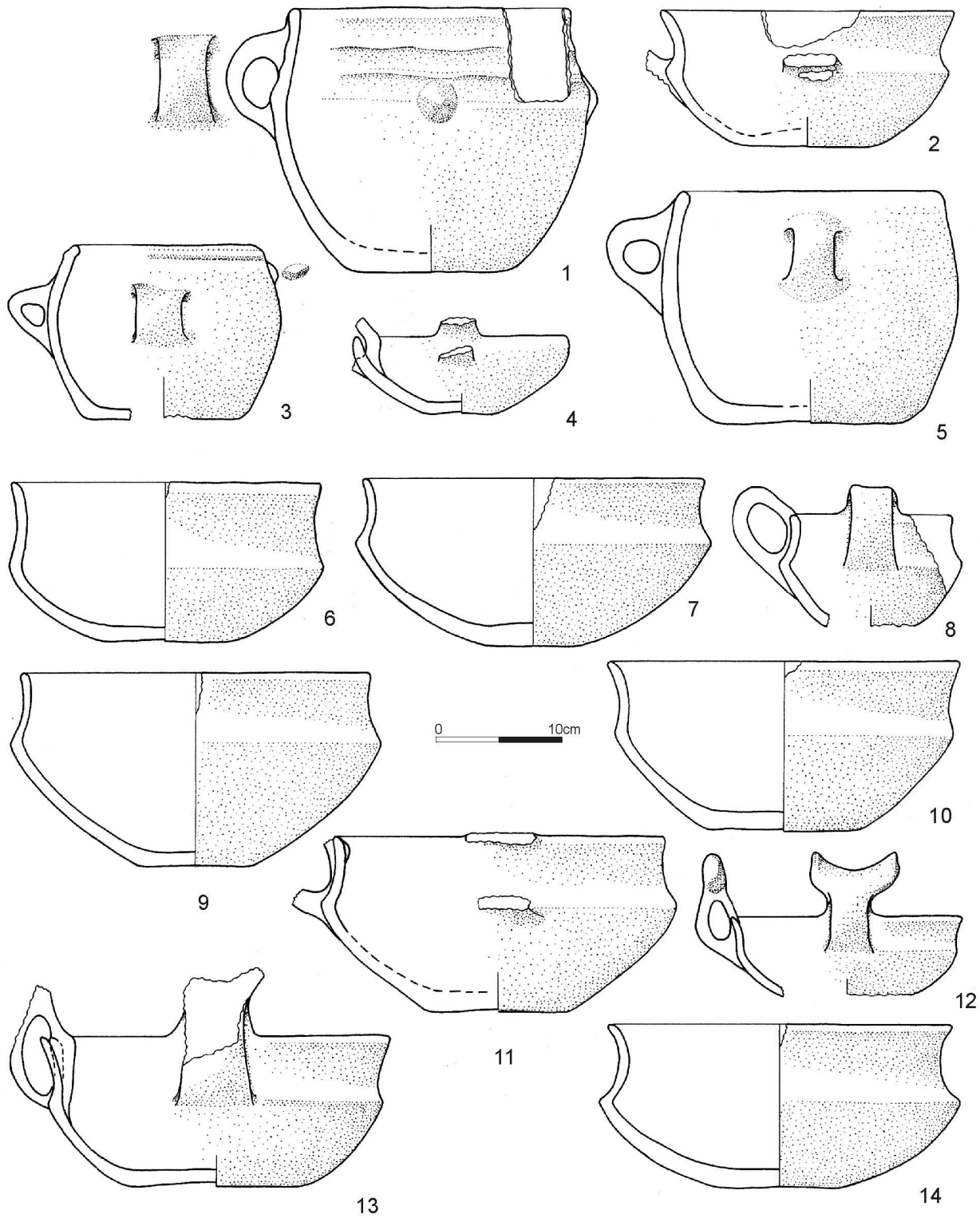

Tav. 174 - Noceto La Torretta: recipienti ceramici interi; 1-5) da UUSS 81, "sotto 81c", 81d-e; 6-14) da US 81c (da Mutti, Pizzi 2009).

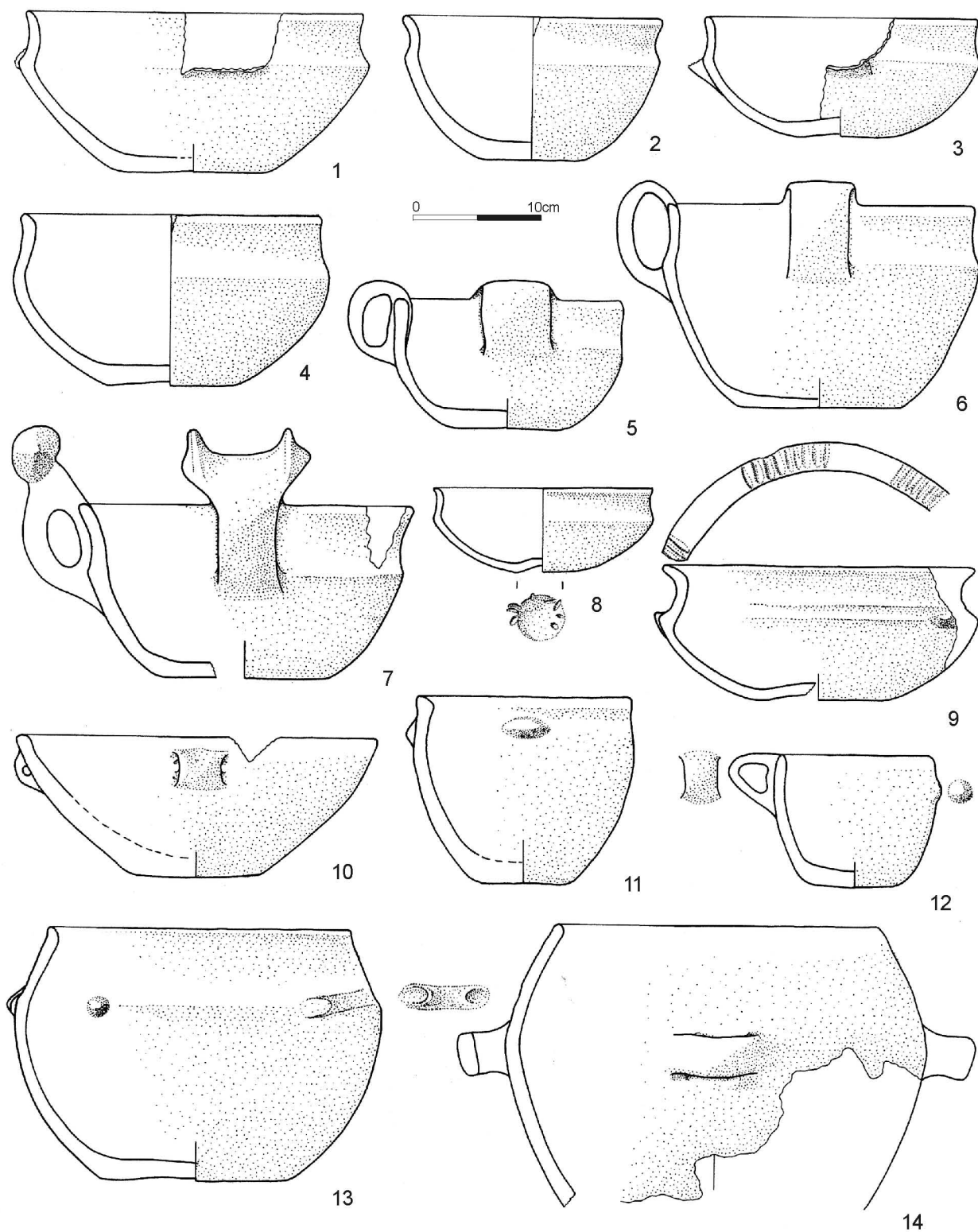

Tav. 175 - Noceto La Torretta: recipienti ceramici interi; 1-14) da US 81c (da Mutti, Pizzi 2009).

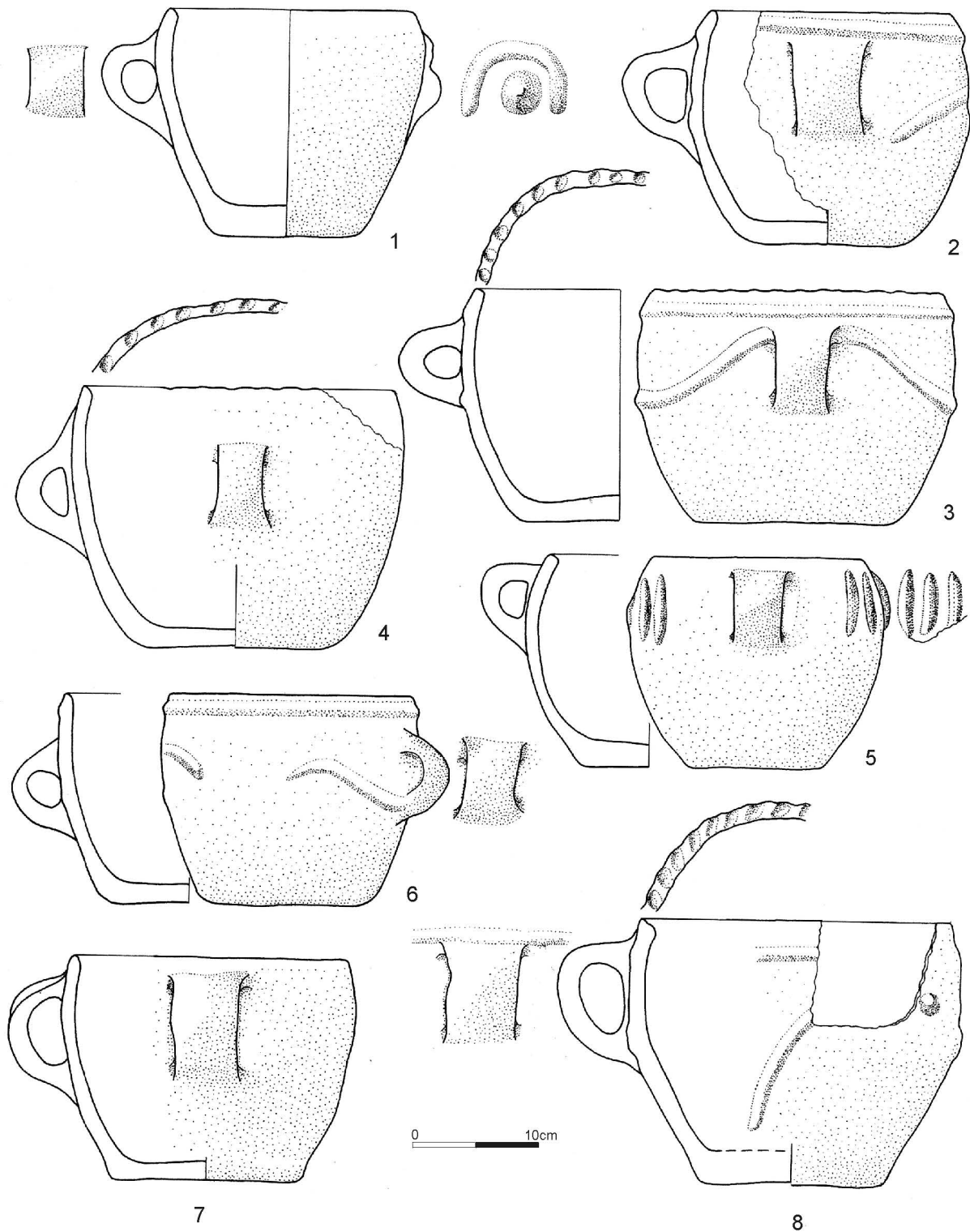

Tav. 176 - Noceto La Torretta: recipienti ceramici interi; 1-8) da US 81c (da Mutti, Pizzi 2009).

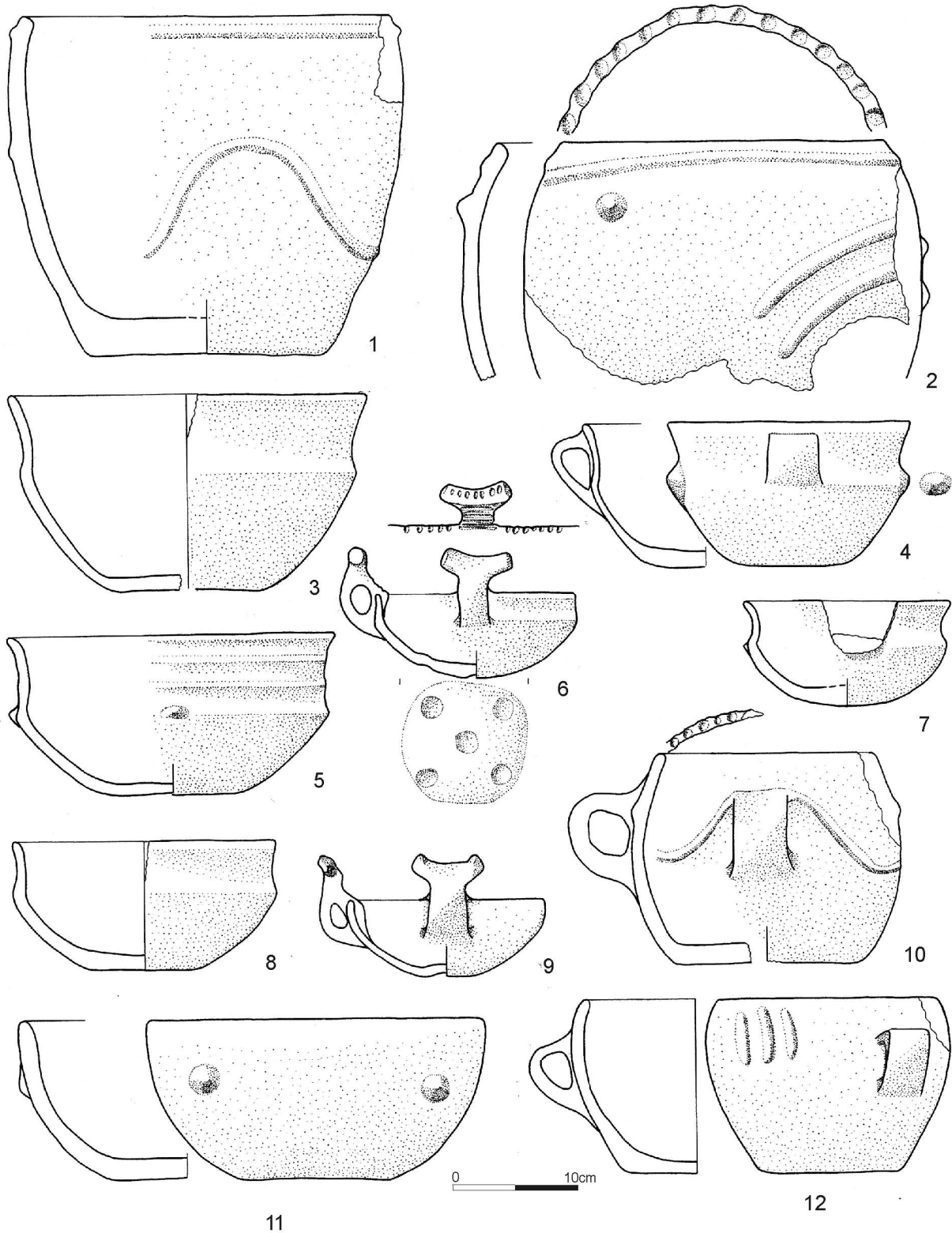

Tav. 177 - Noceto La Torretta: recipienti ceramici interi; 1, 2) da US 81c; 3-7, 9, 10) da US 80; 8, 11, 12) da US 31 (da Mutti, Pizzi 2009).

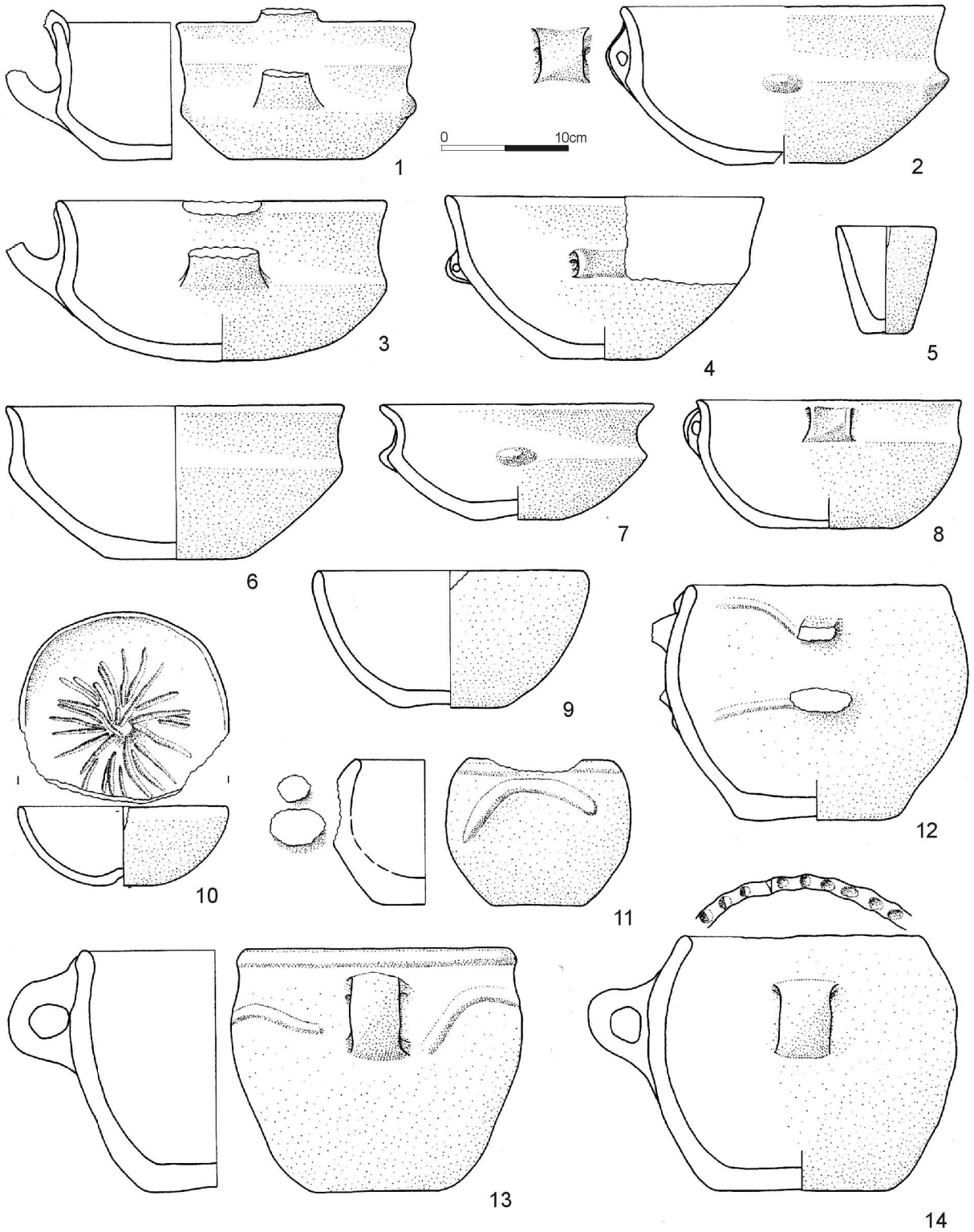

Tav. 178 - Noceto La Torretta: recipienti ceramici interi; 1-14) da US 66base (da Mutti, Pizzi 2009).

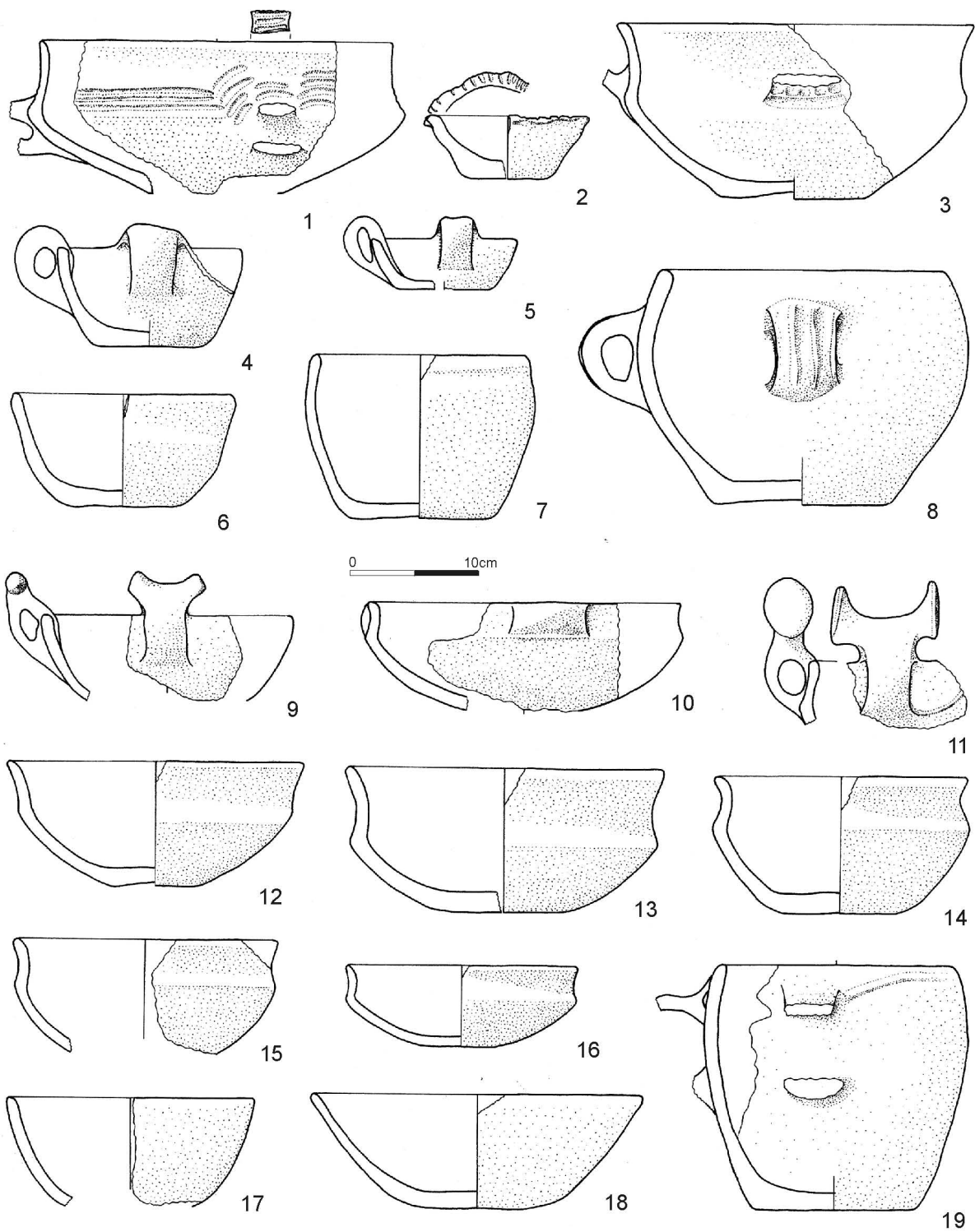

Tav. 179 - Noceto La Torretta: recipienti ceramici interi; 1-8) da UUSS 66 e 66α; 9-19) da US 28 (da Mutti, Pizzi 2009).

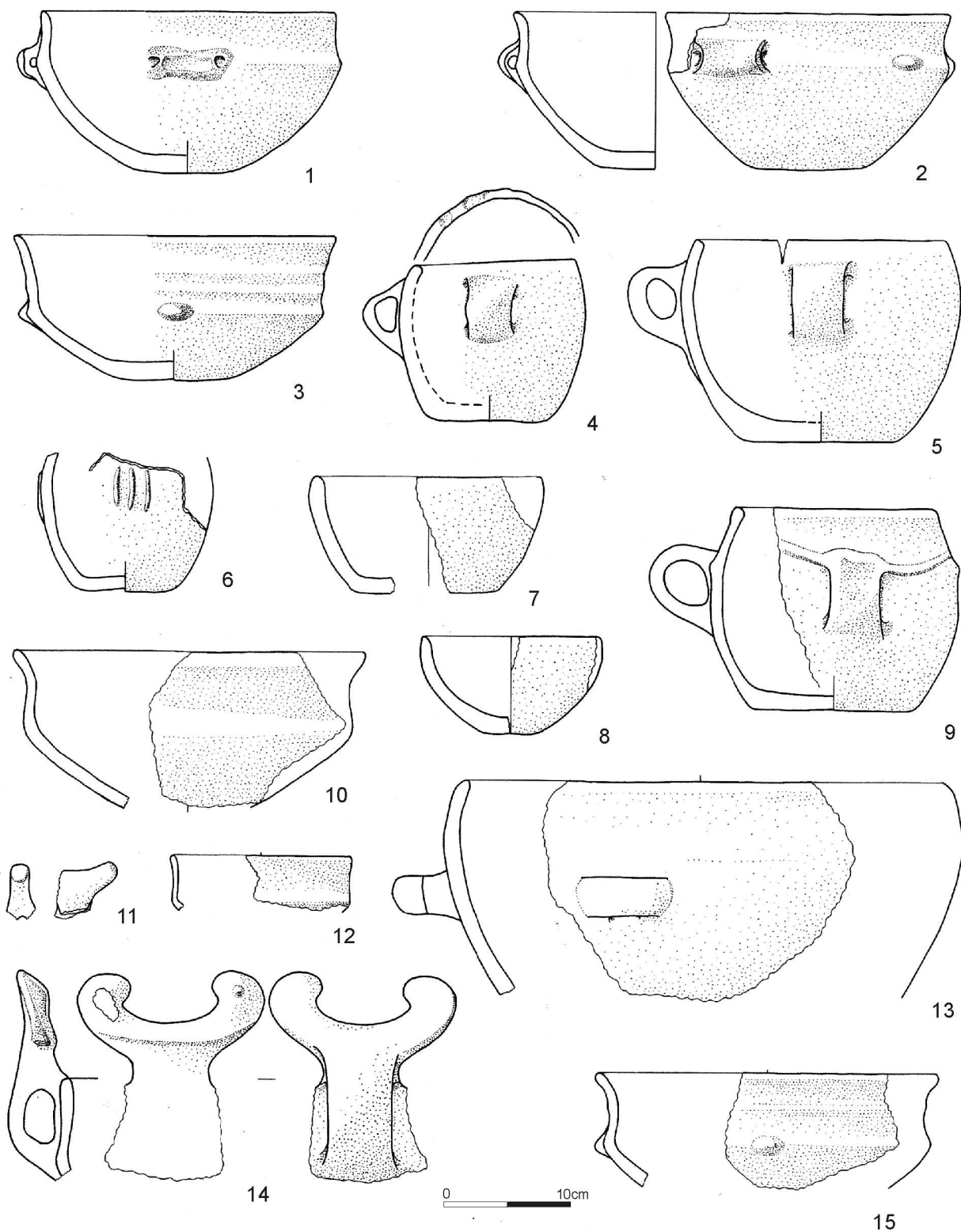

Tav. 180 - Noceto La Torretta: recipienti ceramici interi; 1-5) da US 197; 6-8) da US 5002 Fb; 9) da US 5017; 10-12) da US 177; 13-15) da US 5003 (da Mutti, Pizzi 2009).

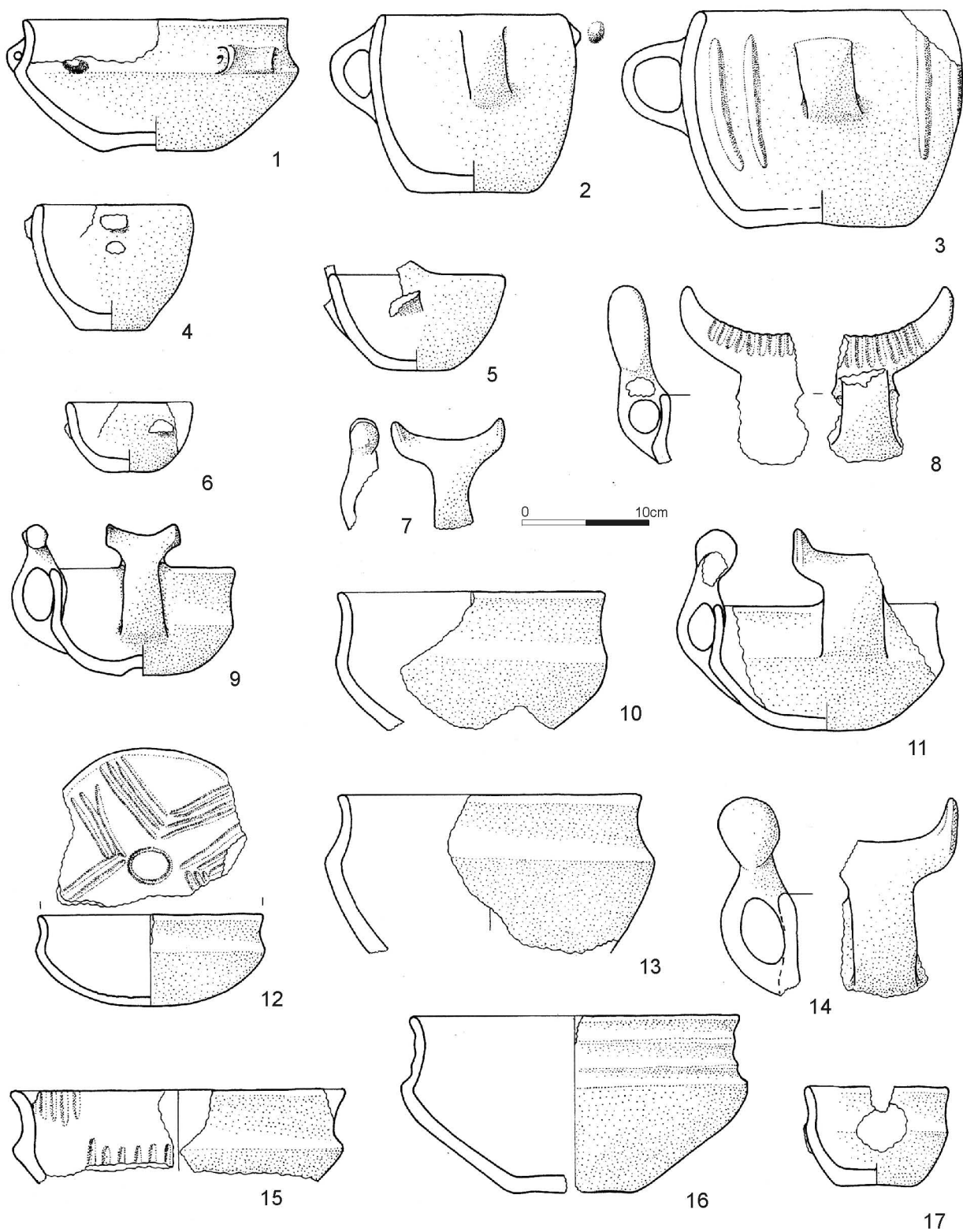

Tav. 181 - Noceto La Torretta: recipienti ceramici interi; 1-4) da US 5002F; 5) da US 5002d; 6) da US 5004; 7, 8) da US 5002e; 9) da US 5002c-e; 10-16) da US 5002a-e; 17) da US 5001 (da Mutti, Pizzi 2009).

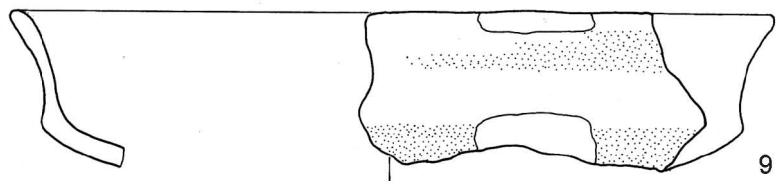
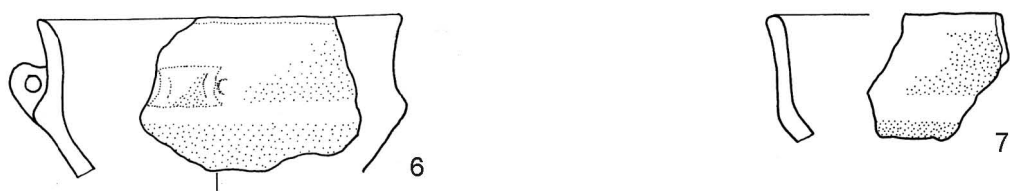
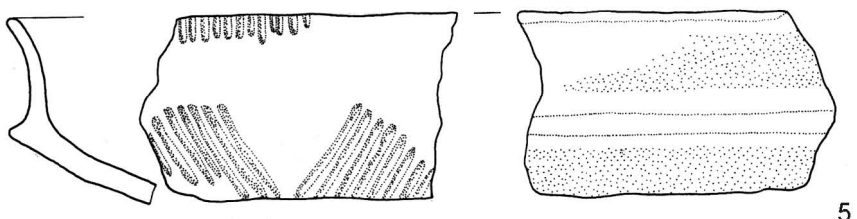
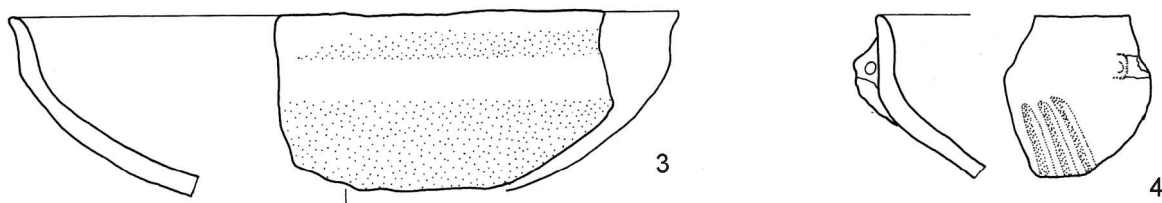
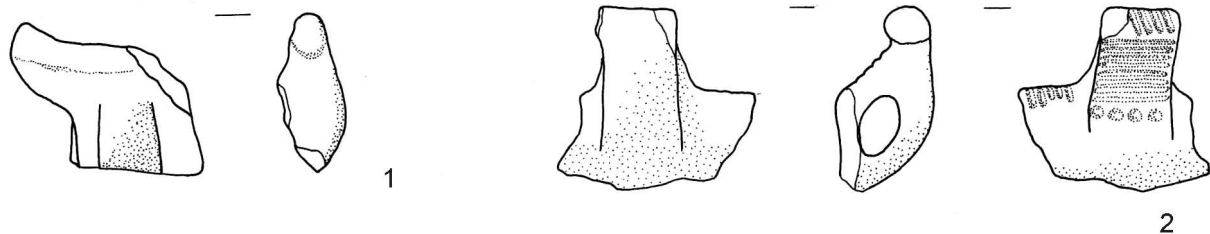

Tav. 182 - Noceto La Torretta: frammenti ceramici; 1-10 da US 89 e 89a (scala 1:3).

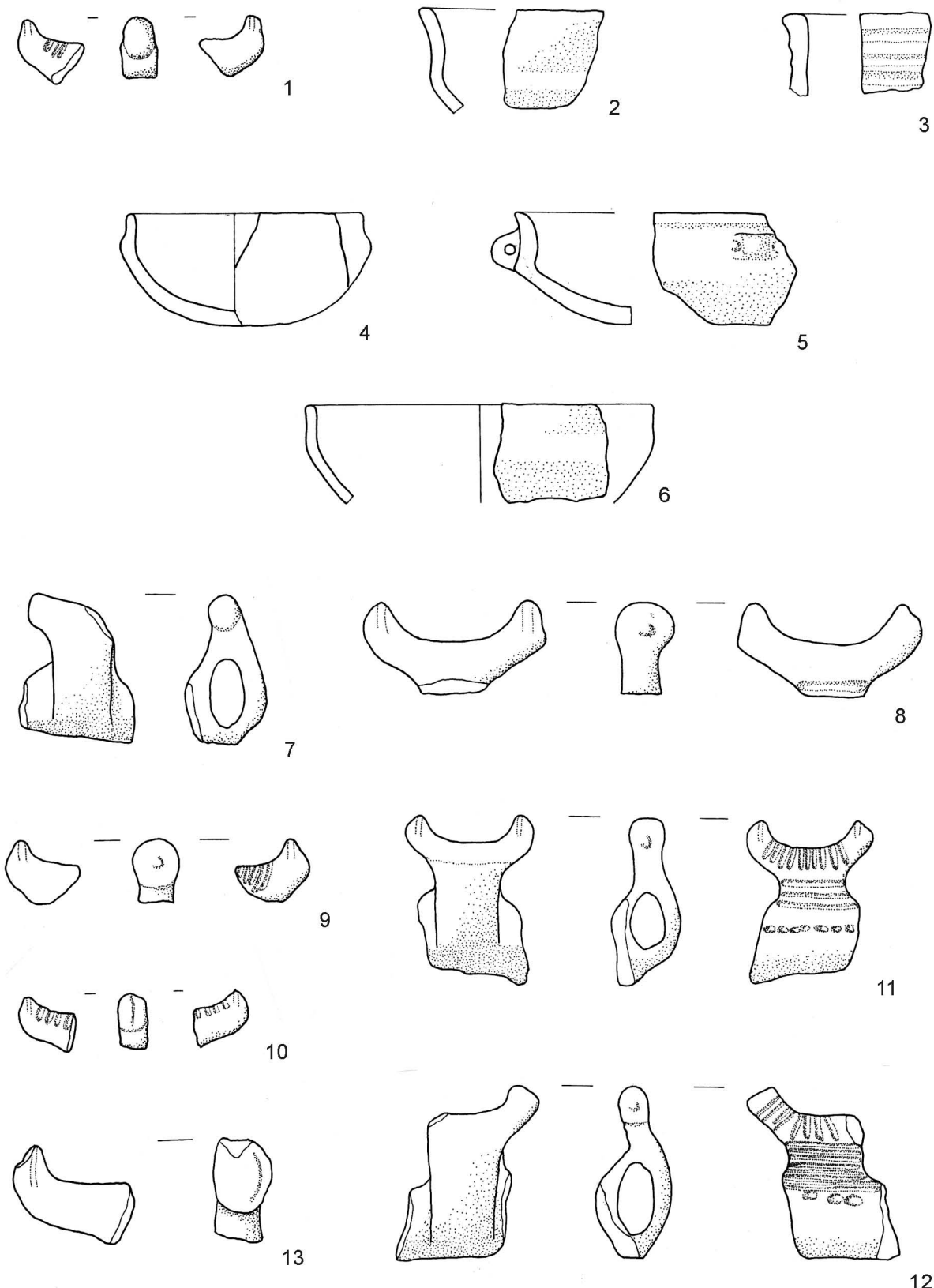

Tav. 183 - Noceto La Torretta: frammenti ceramici; 1-3) da US 87 base; 4-6) da US 87a; 7-13) da US 87 (scala 1:3).

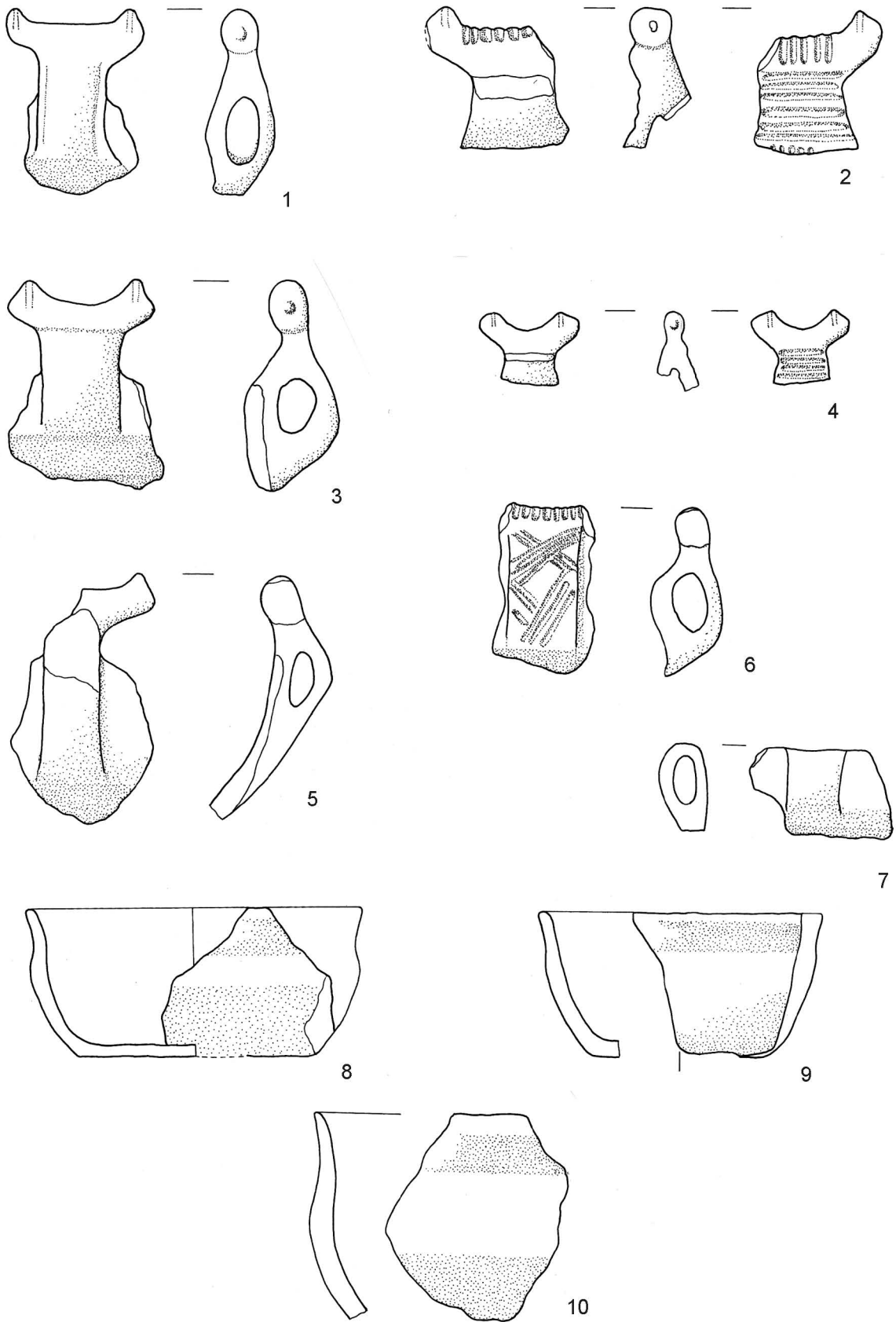

Tav. 184 - Noceto La Torretta: frammenti ceramici; 1-10) da US 87 (scala 1:3).

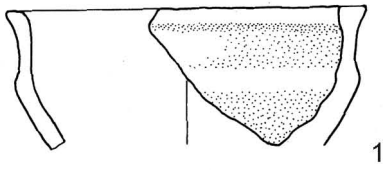

1

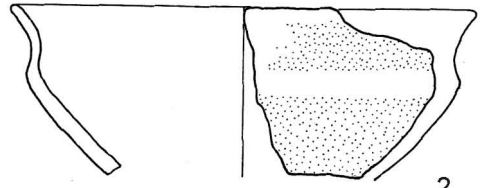

2

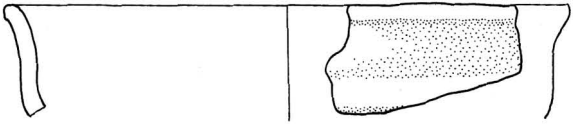

3

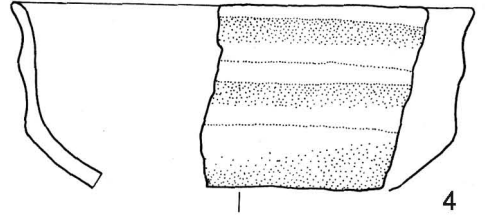

4

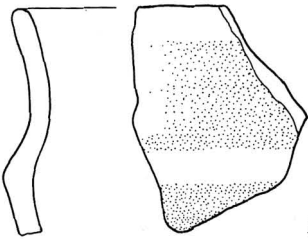

5

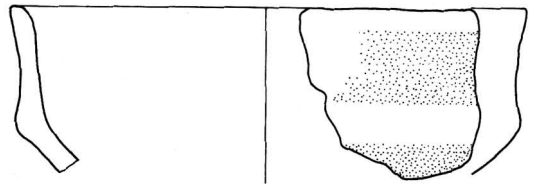

6

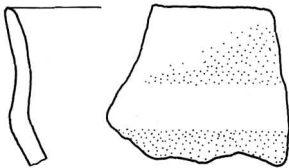

7

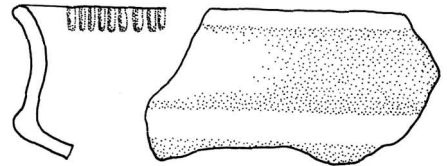

8

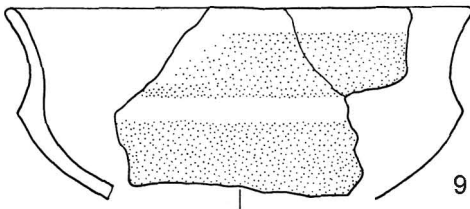

9

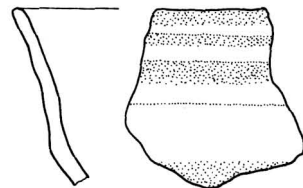

10

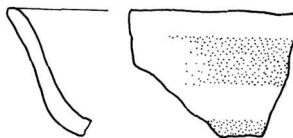

11

Tav. 185 - Noceto La Torretta: frammenti ceramici; 1-11) da US 87 (scala 1:3).

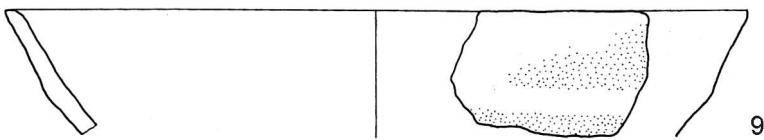
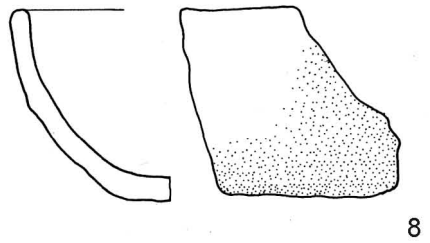
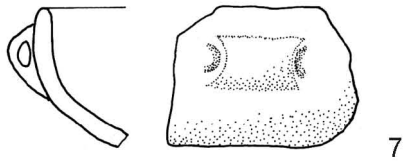
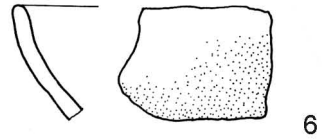
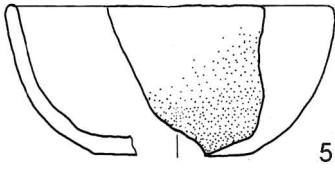
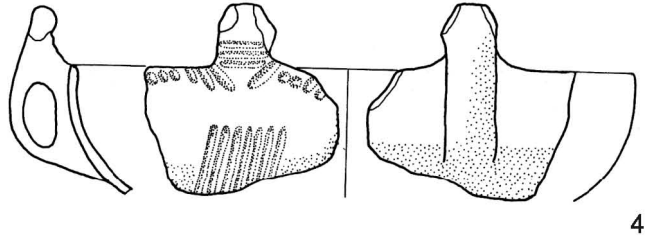
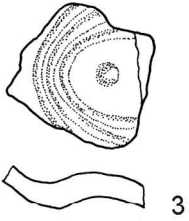
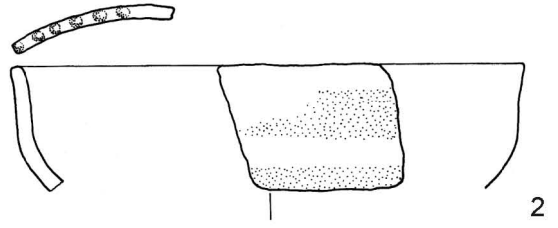
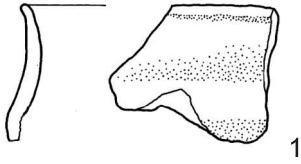

Tav. 186 - Noceto La Torretta: frammenti ceramici; 1-9 da US 87 (scala 1:3).

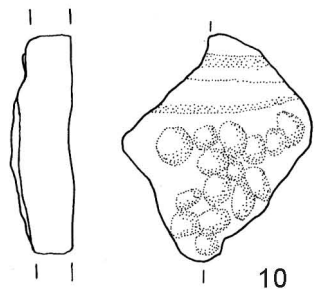
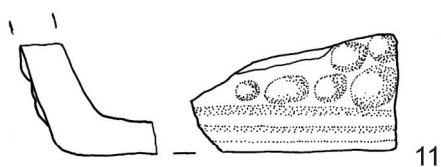
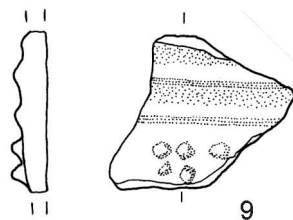
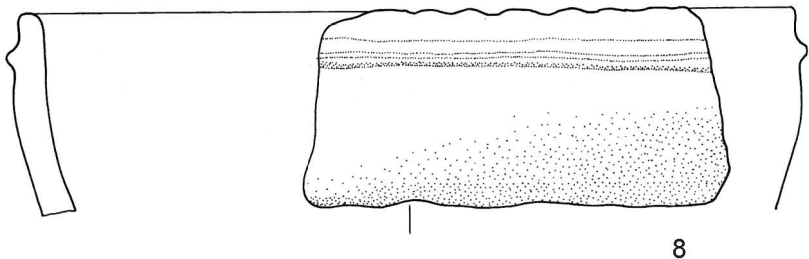
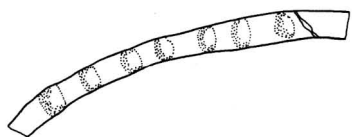
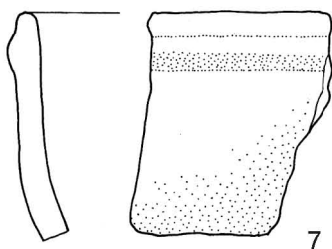
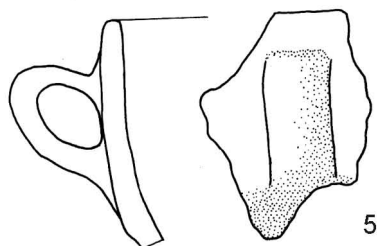
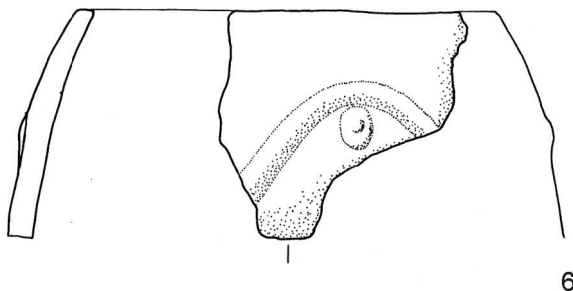
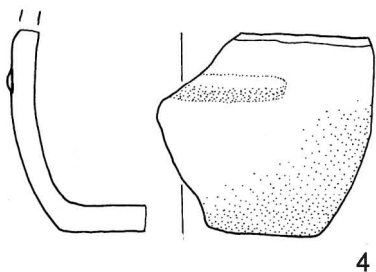
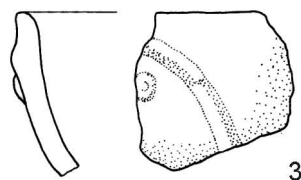
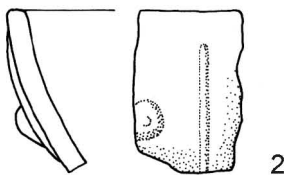
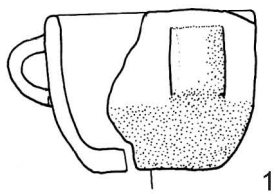

Tav. 187 - Noceto La Torretta: frammenti ceramici; 1-11) da US 87 (scala 1:3).

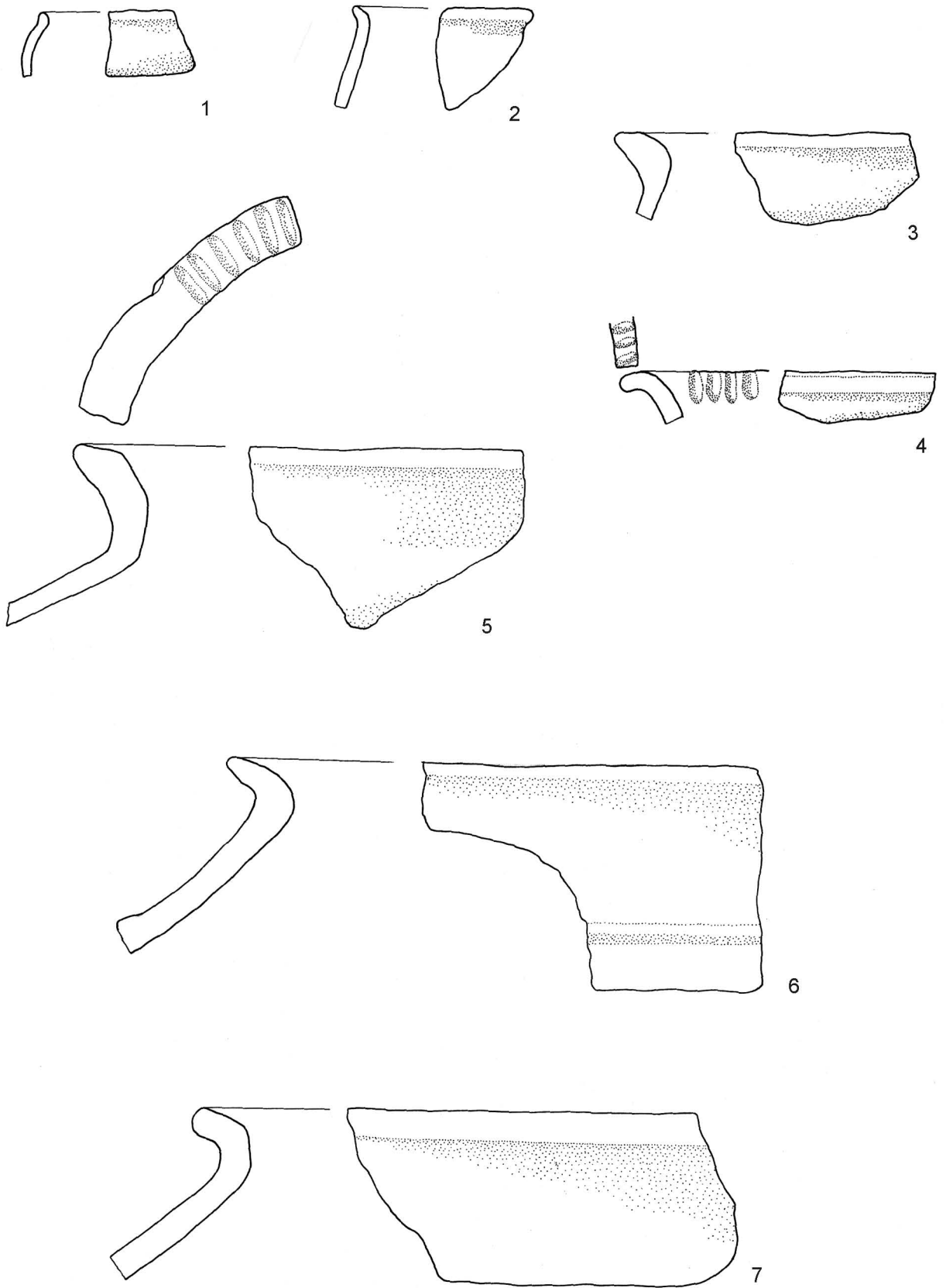

Tav. 188 - Noceto La Torretta: frammenti ceramici; 1-7) da US 87 (scala 1:3).

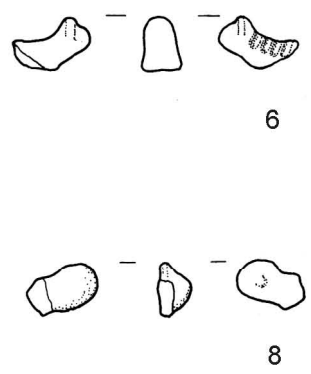
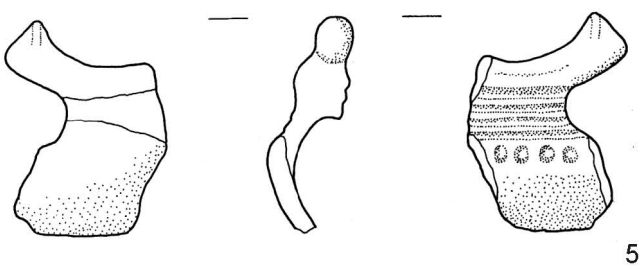
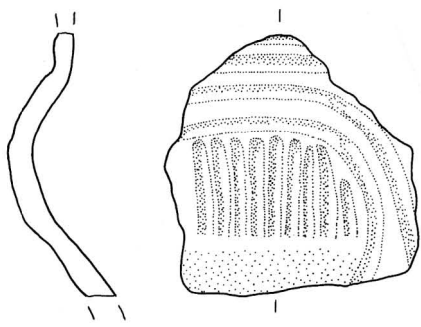
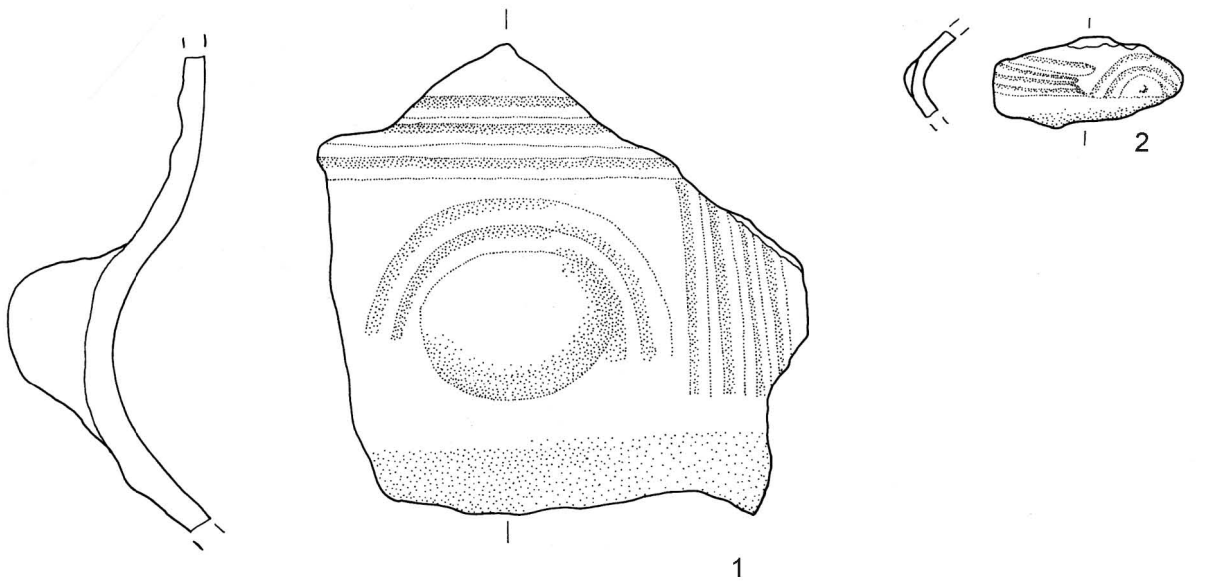

Tav. 189 - Noceto La Torretta: frammenti ceramici; 1-4) da US 87; 5-8) da US 85 (scala 1:3).

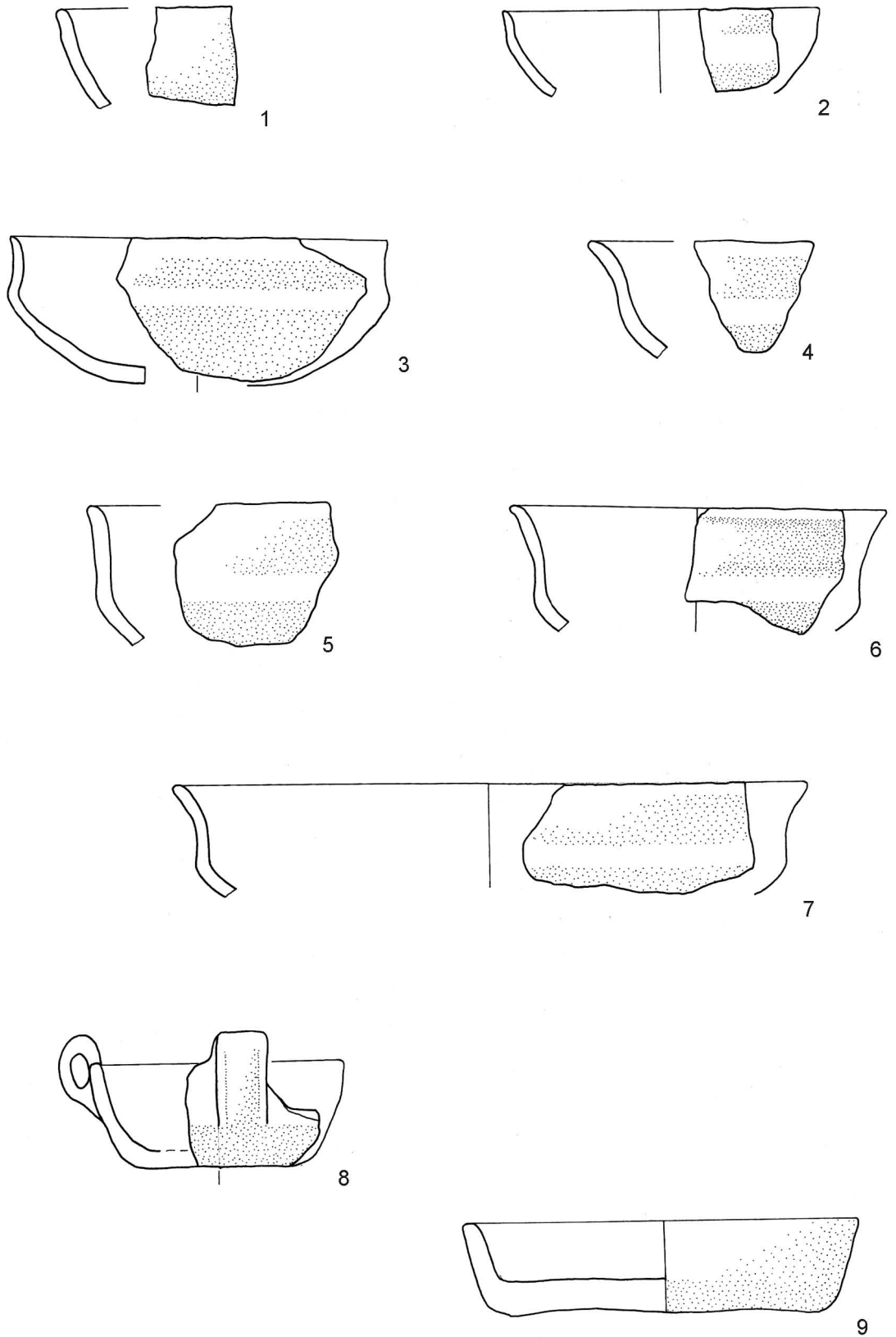

Tav. 190 - Noceto La Torretta: frammenti ceramici; 1-9) da US 85 (scala 1:3).

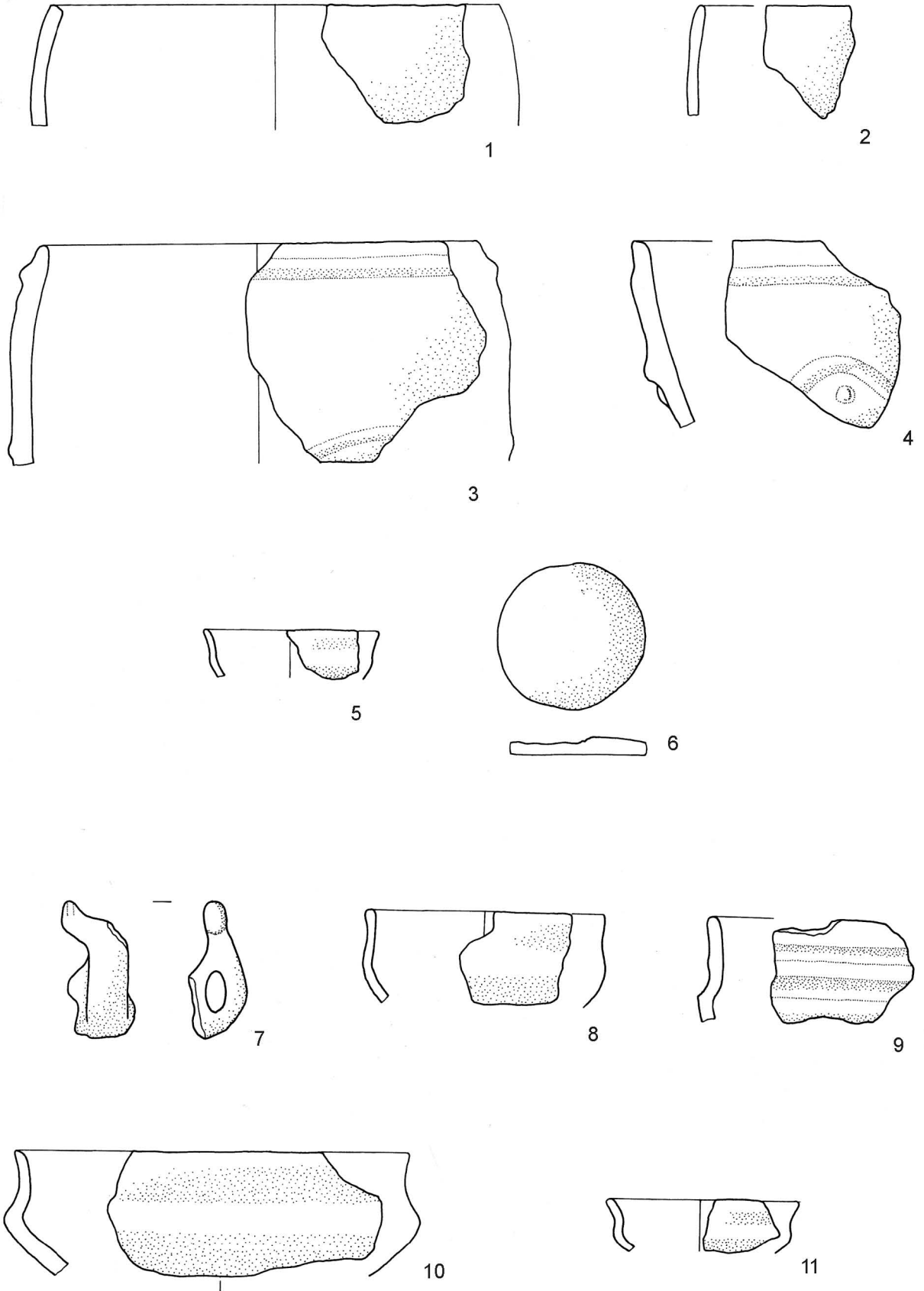

Tav. 191 - Noceto La Torretta: frammenti ceramici; 1-6) da US 85; 7-11) da US 141 (scala 1:3).

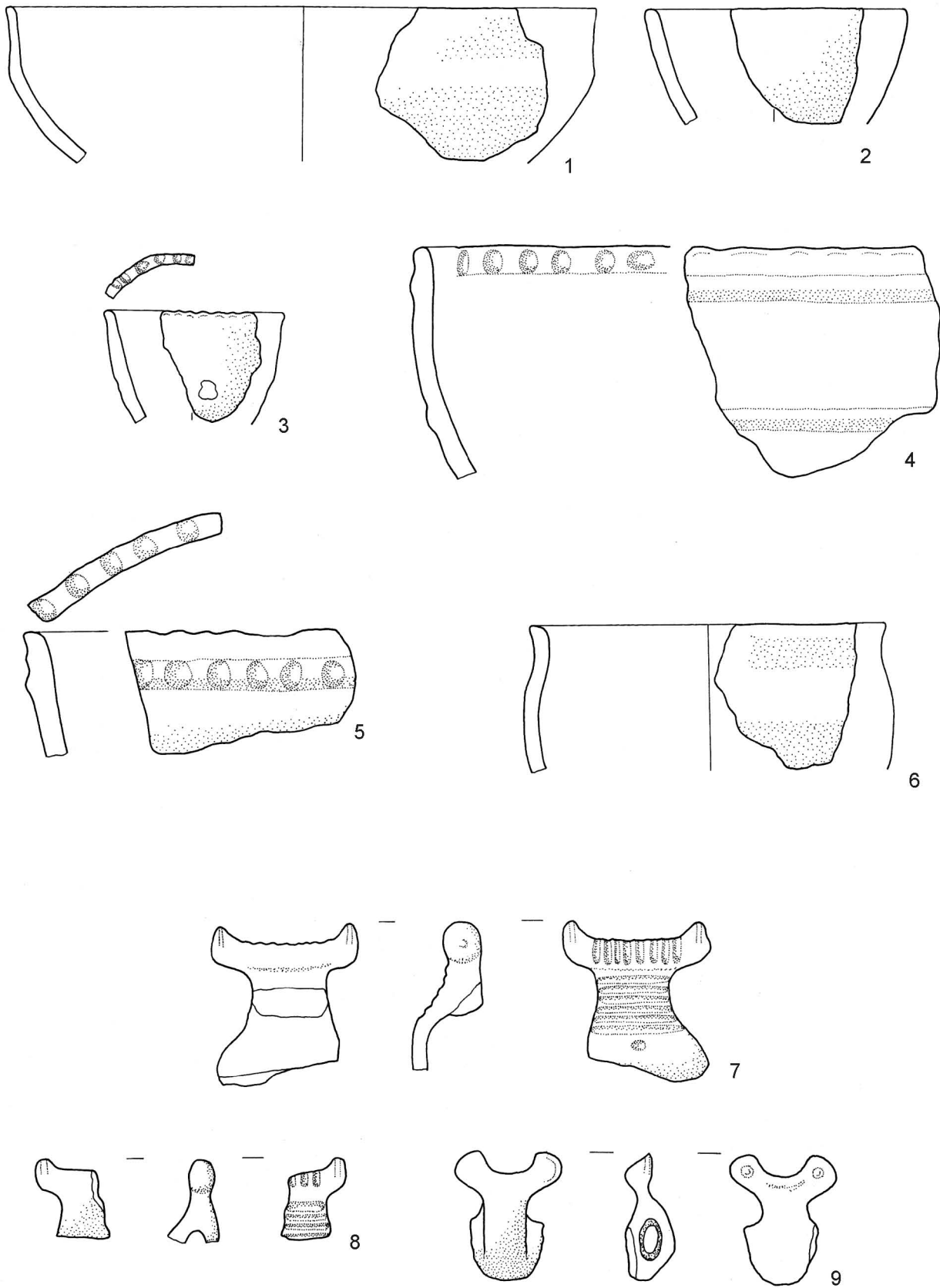

Tav. 192 - Noceto La Torretta: frammenti ceramici; 1-6) da US 141; 7-9) da US 84 (scala 1:3).

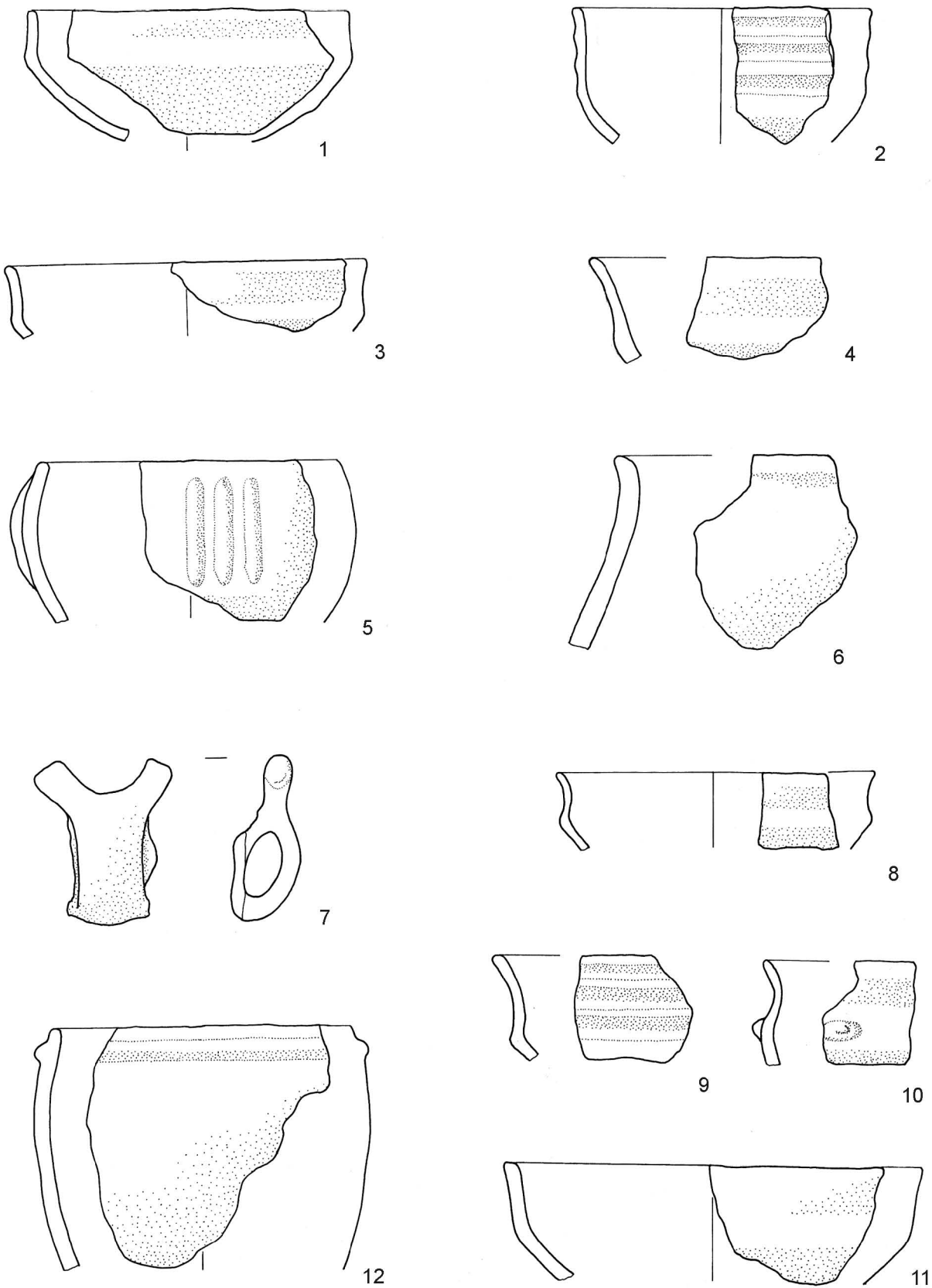

Tav. 193 - Noceto La Torretta: frammenti ceramici; 1-6) da US 84; 7-12) da US 83 (scala 1:3).

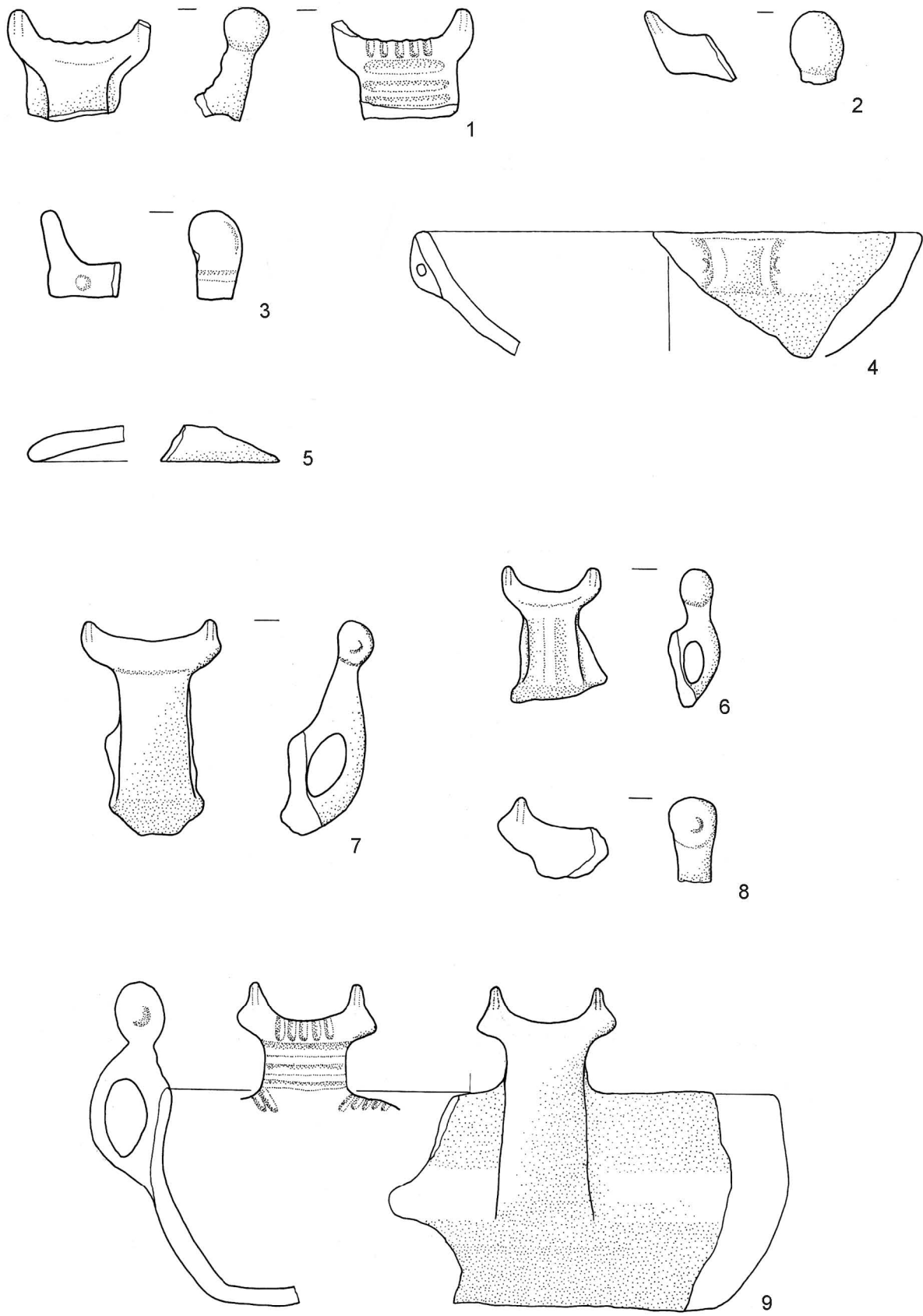

Tav. 194 - Noceto La Torretta: frammenti ceramici; 1-5) da US 81; 6-9) da US 80 (scala 1:3).

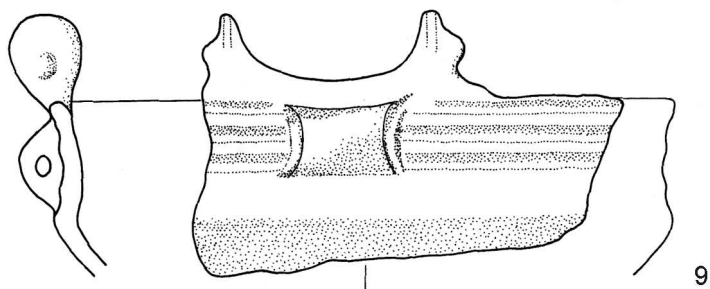
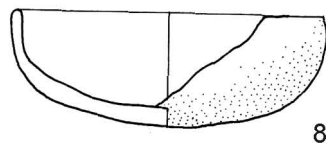
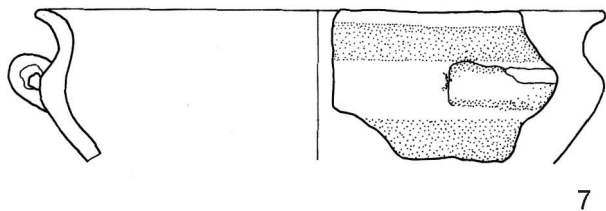
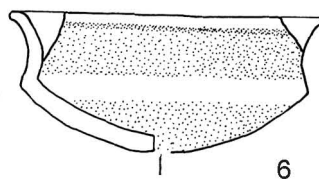
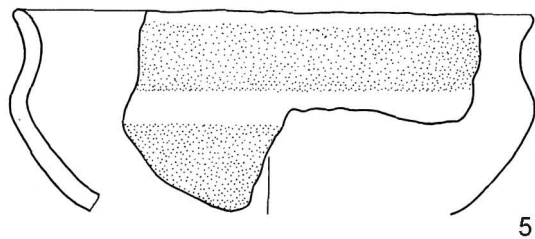
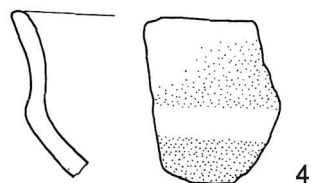
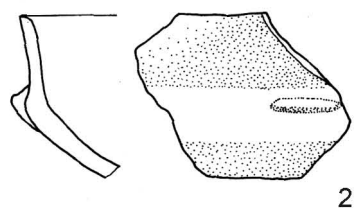
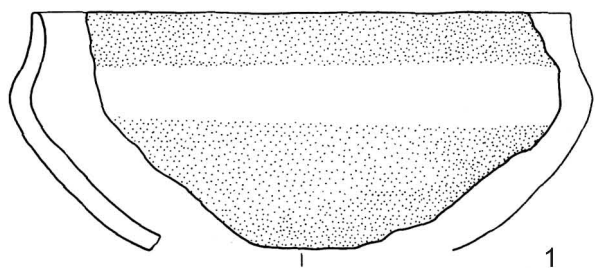

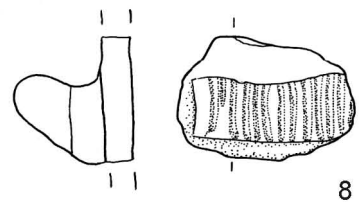
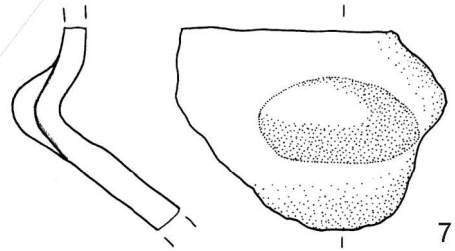
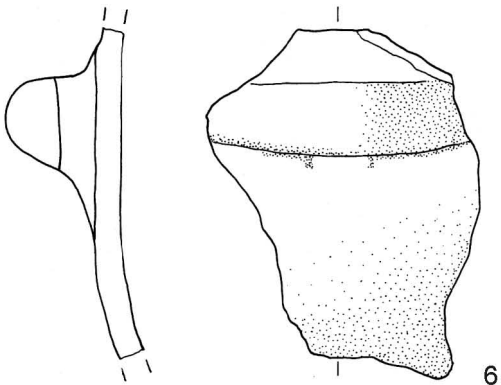
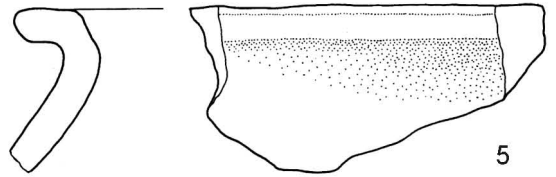
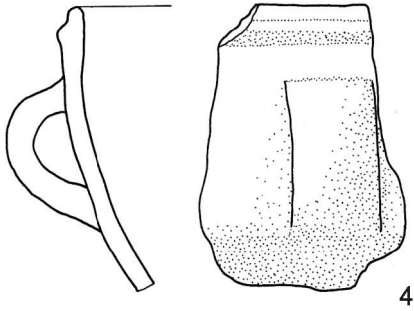
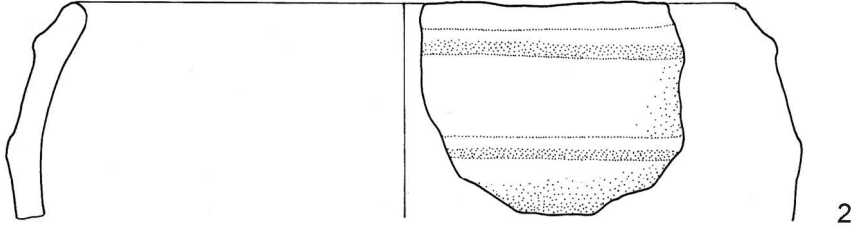
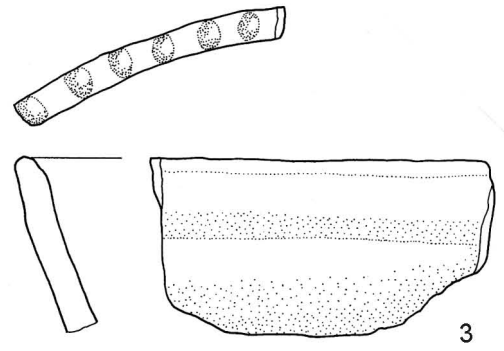
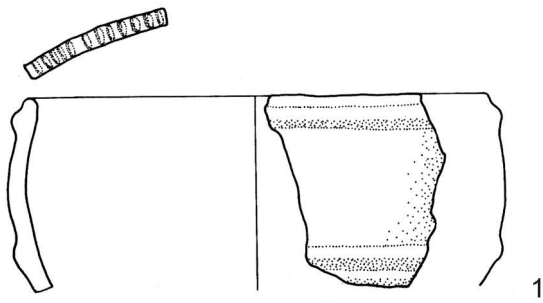

Tav. 196 - Noceto La Torretta: frammenti ceramici; 1-3) da US 80; 4-8) da US 66 β (scala 1:3).

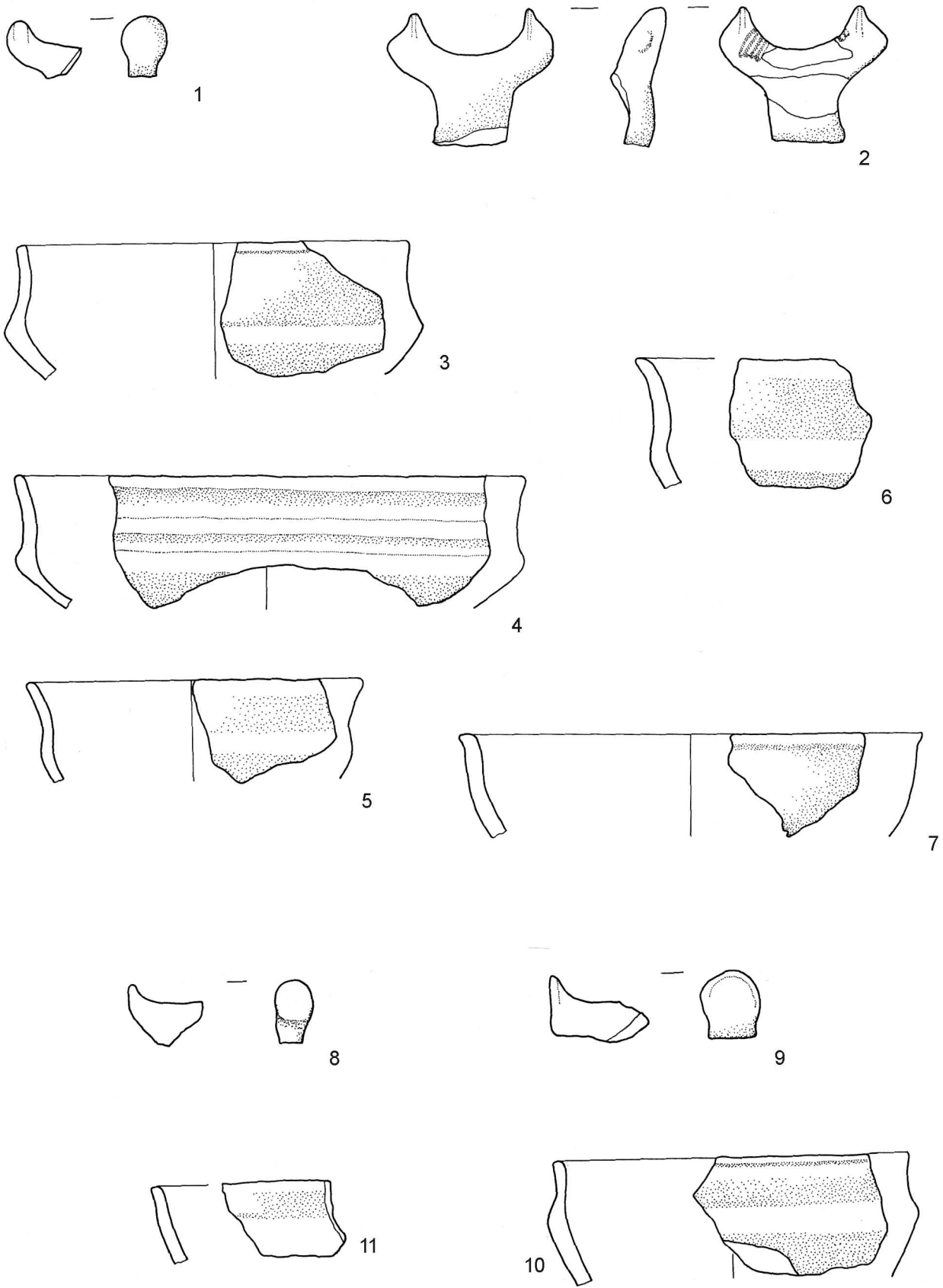

Tav. 197 - Noceto La Torretta: frammenti ceramici; 1-7) da US 66 β ; 8-11) da US 66 α (scala 1:3).

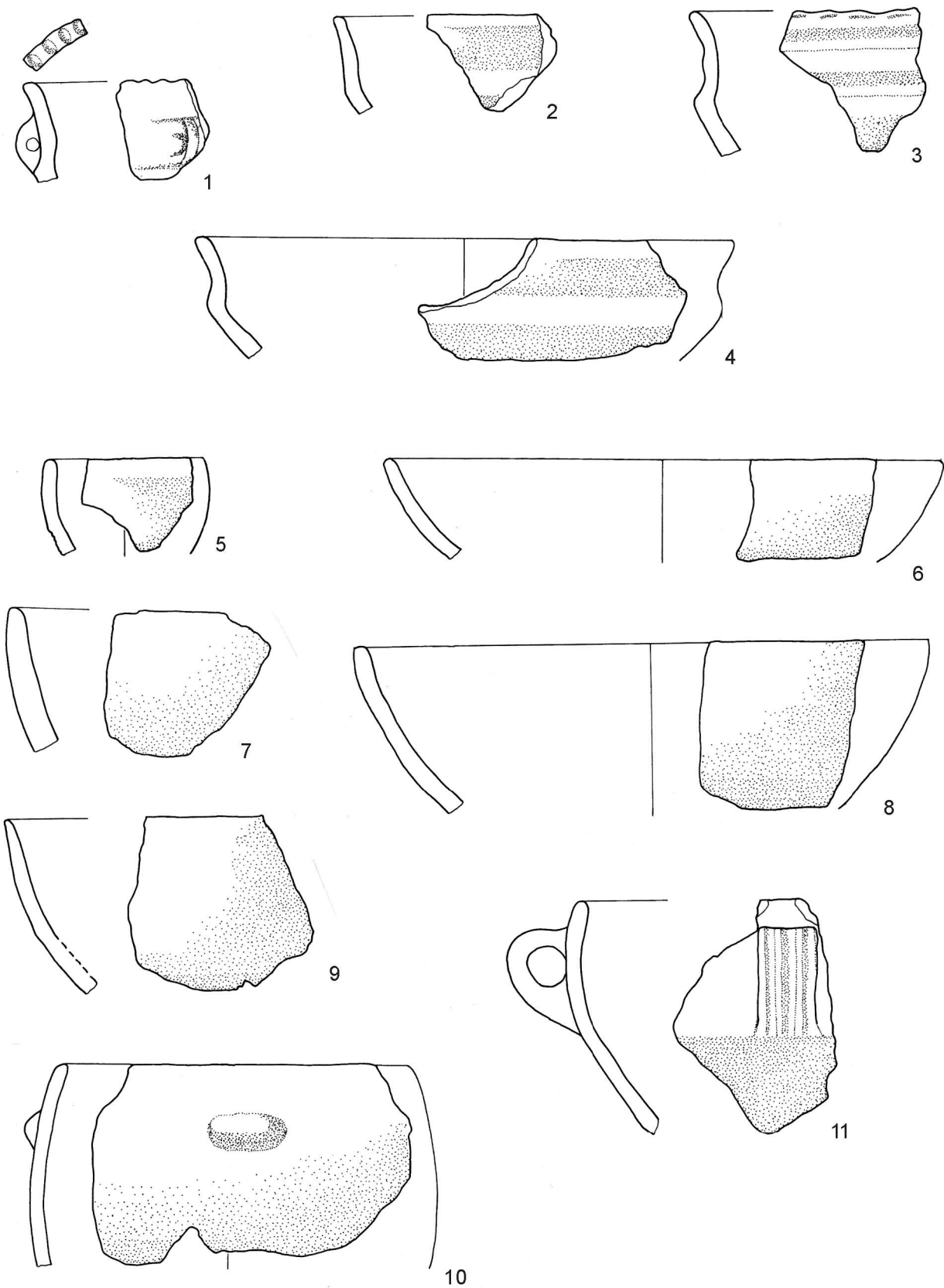

Tav. 198 - Noceto La Torretta: frammenti ceramici; 1-11) da US 66α (scala 1:3).

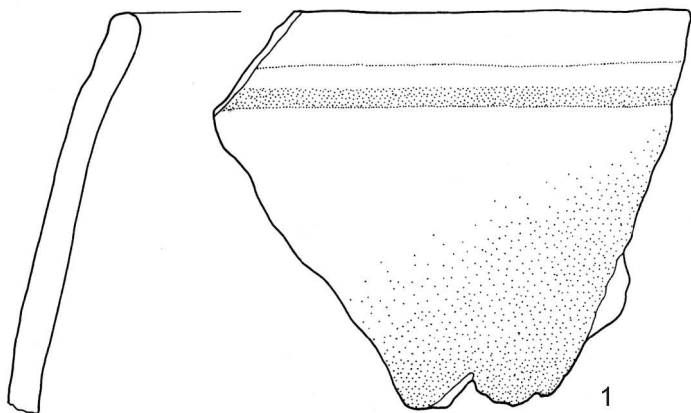

1

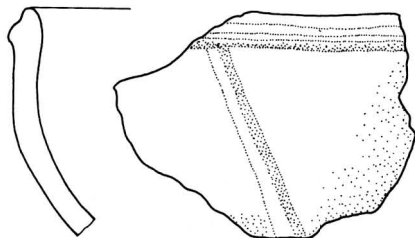

2

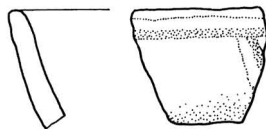

3

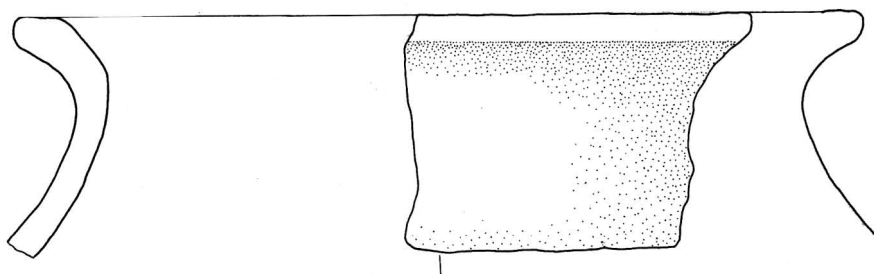

4

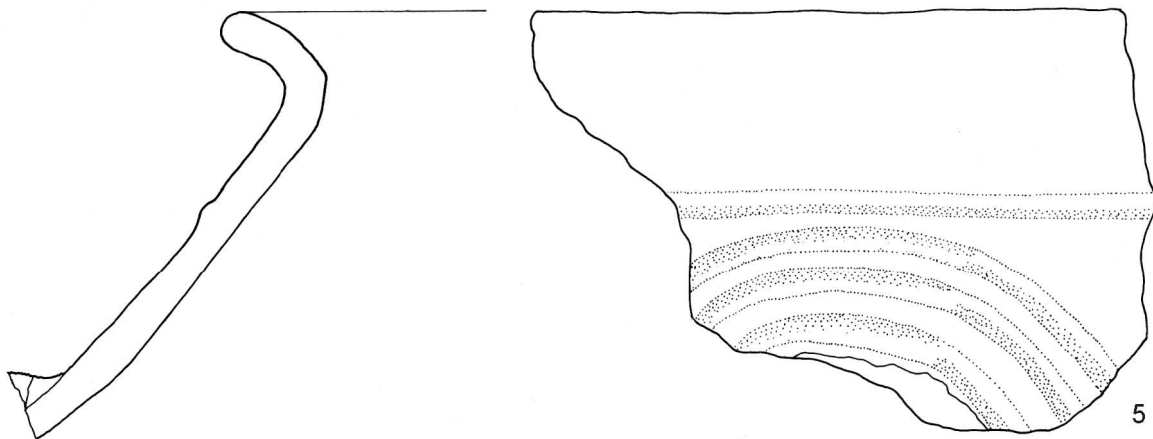
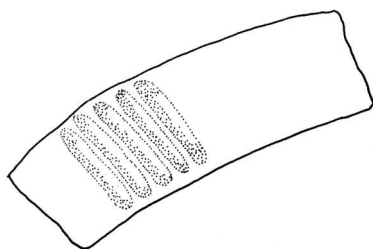

5

Tav. 199 - Noceto La Torretta: frammenti ceramici; 1-5) da US 66α (scala 1:3).

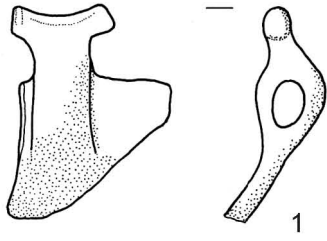

1

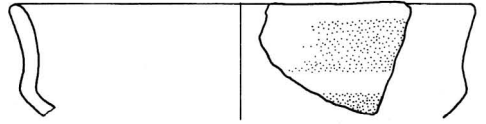

3

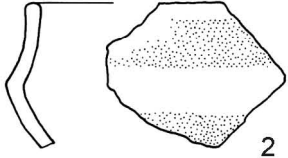

2

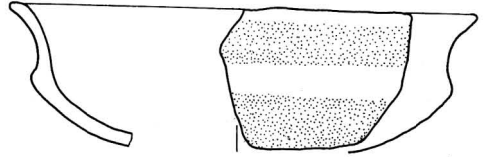

4

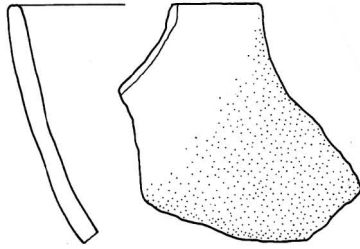

5

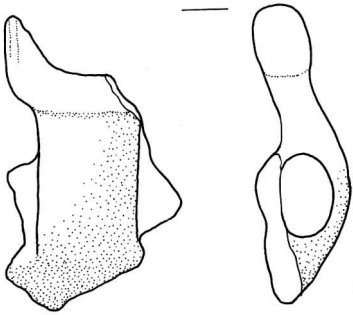

6

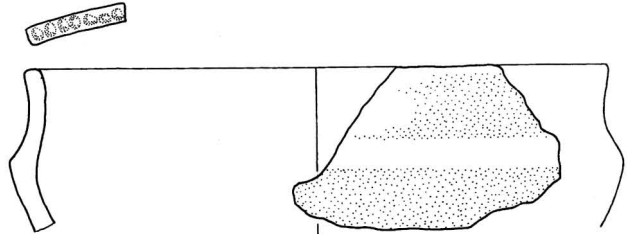

7

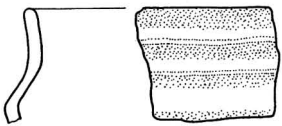

8

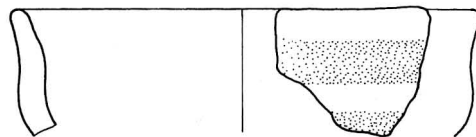

9

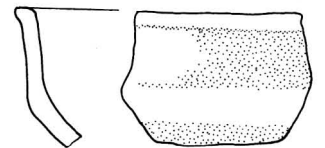

10

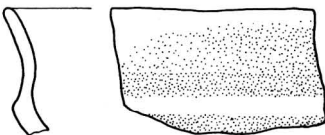

11

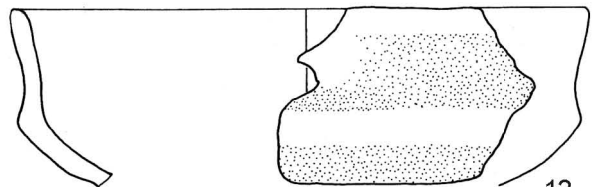

12

Tav. 200 - Noceto La Torretta: frammenti ceramici; 1-5) da US 31; 6-12) da US 28b (scala 1:3).

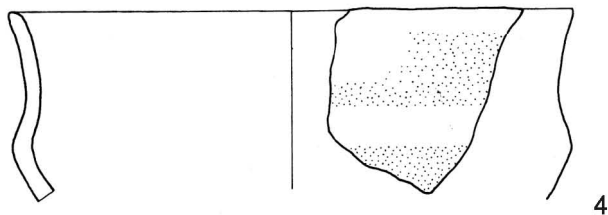
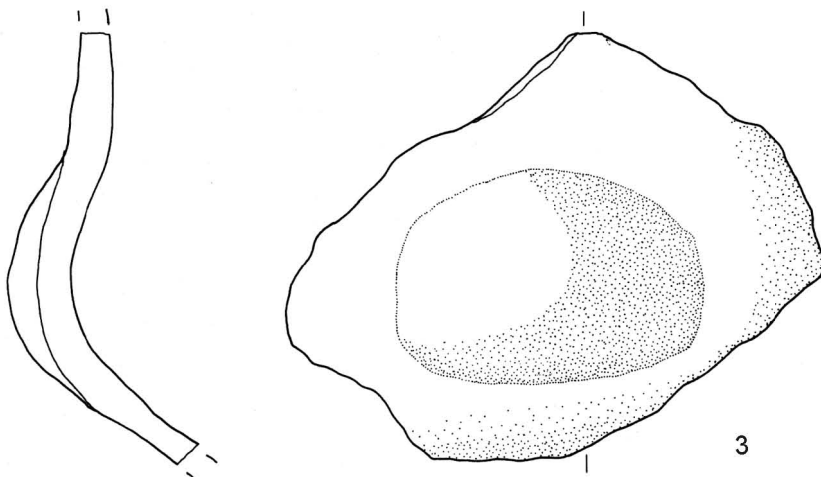
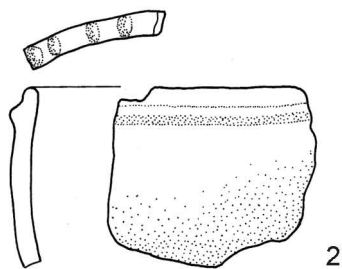
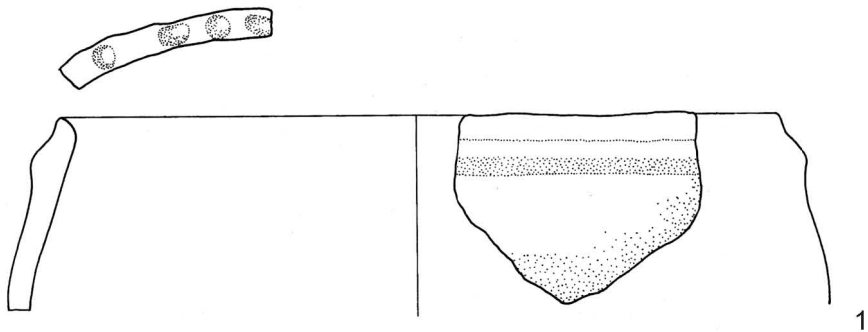

Tav. 201 - Noceto La Torretta: frammenti ceramici; 1-3) da US 28b; 4) da US 28a (scala 1:3).

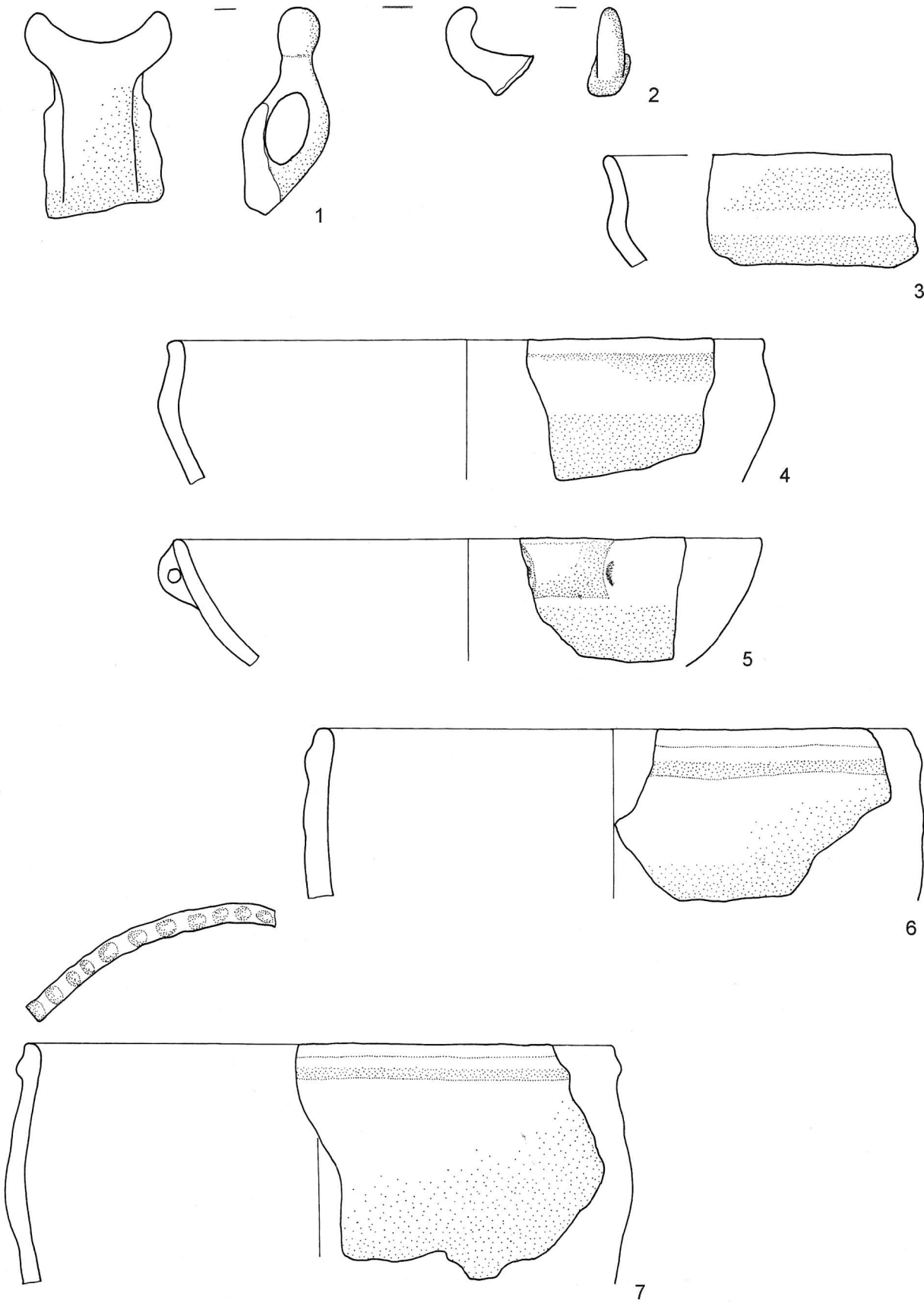

Tav. 202 - Noceto La Torretta: frammenti ceramici; 1-7) da US 5003b (scala 1:3).

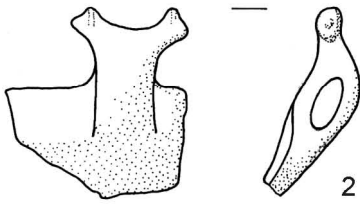

2

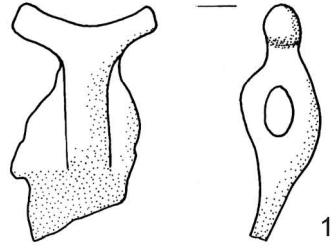

1

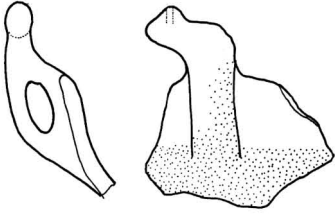

3



4

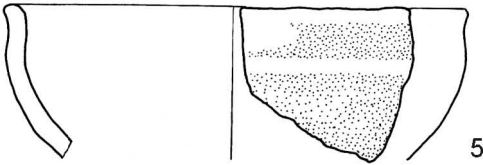

5

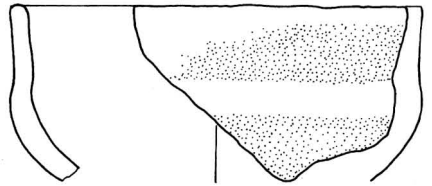

6

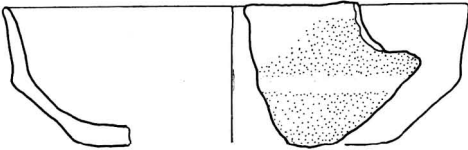

7

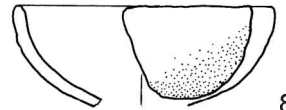

8

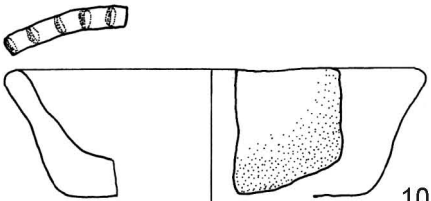

10



9

Tav. 203 - Noceto La Torretta: frammenti ceramici; 1-2 da US 5007; 3-10 da US 5004 (scala 1:3).

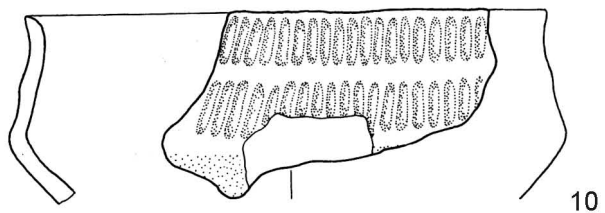
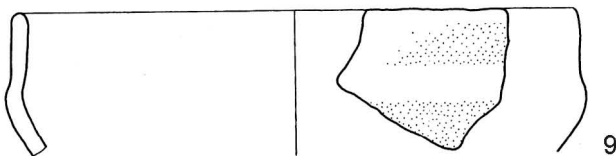
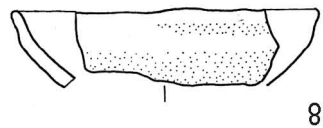
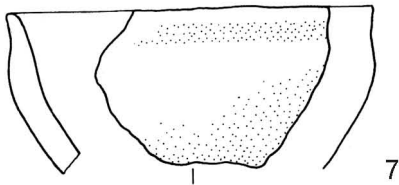
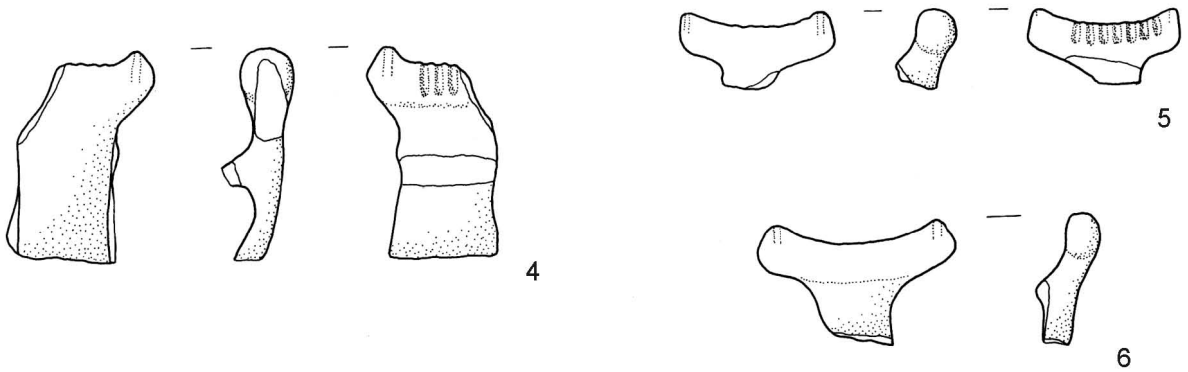
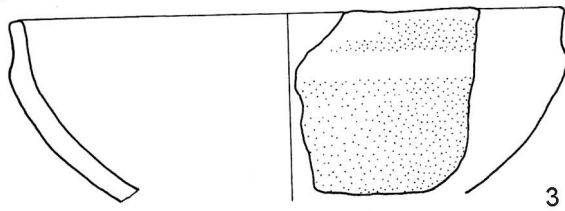
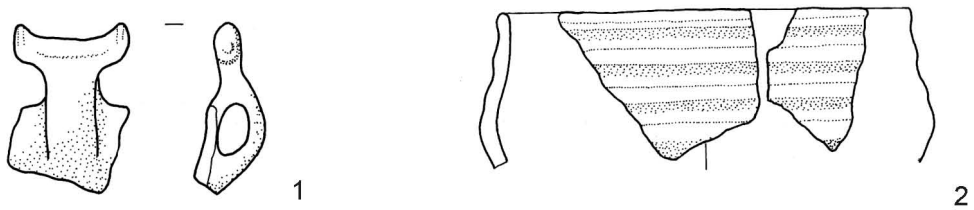

Tav. 204 - Noceto La Torretta: frammenti ceramici; 1-3 da US 197; 4-10 da US 5020 (scala 1:3).

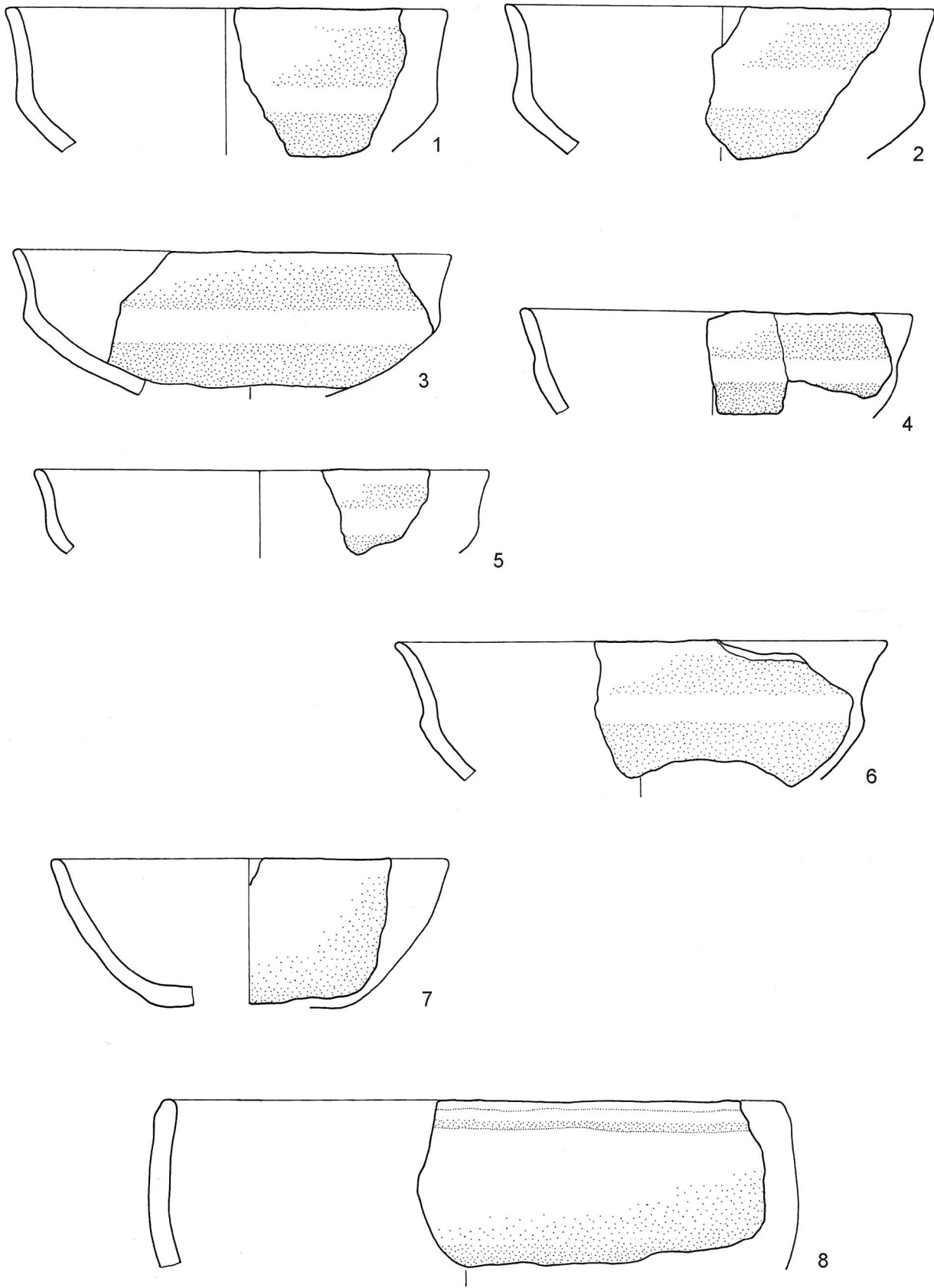

Tav. 205 - Noceto La Torretta: frammenti ceramici; 1-8) da US 5020 (scala 1:3).

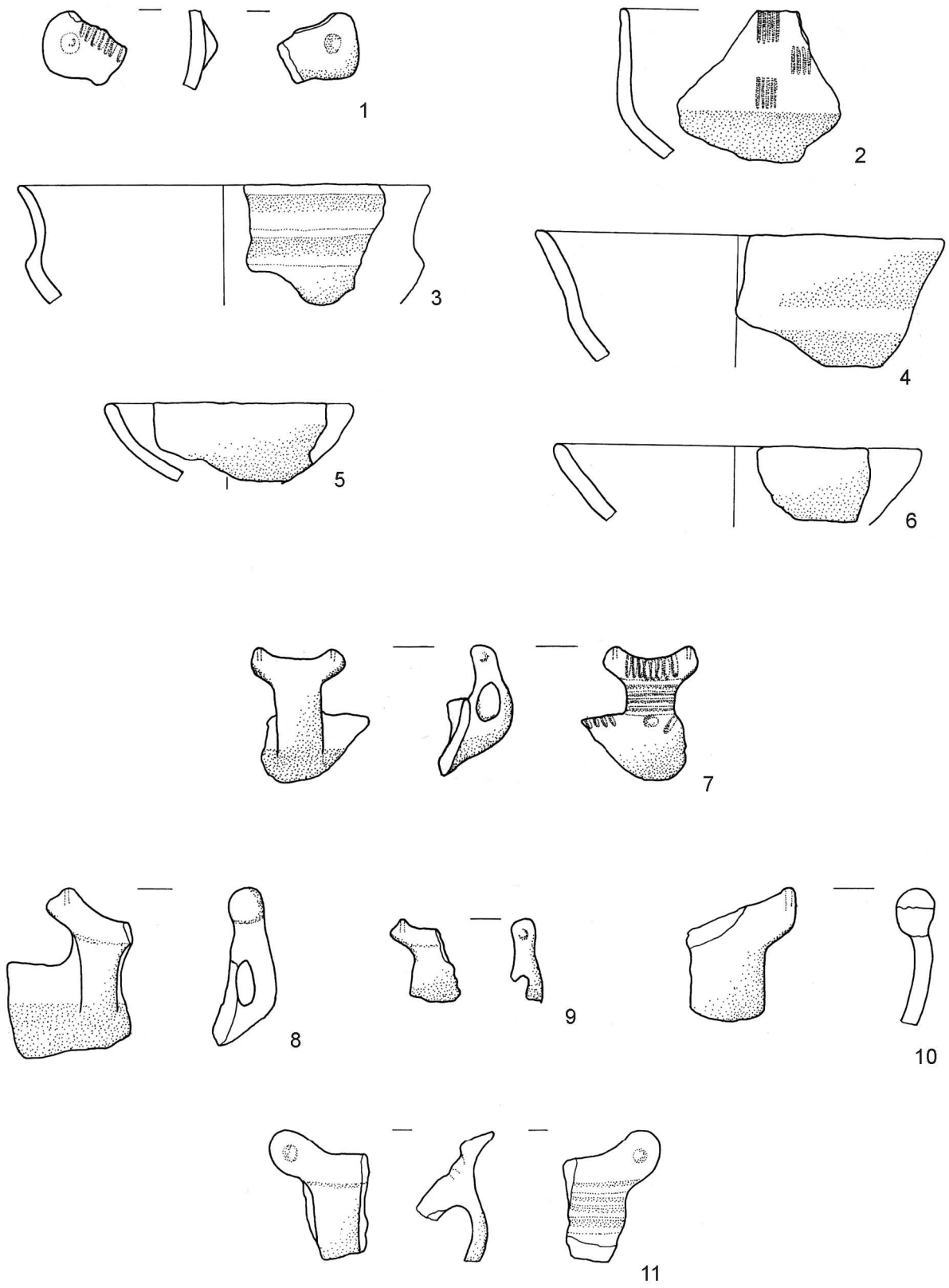

Tav. 206 - Noceto La Torretta: frammenti ceramici; 1-6) da US 5017b; 7-11) da US 5017 (scala 1:3).

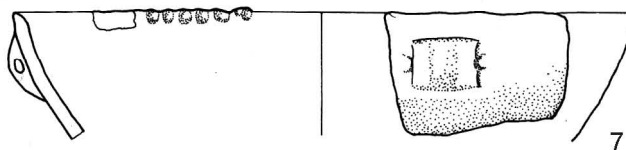
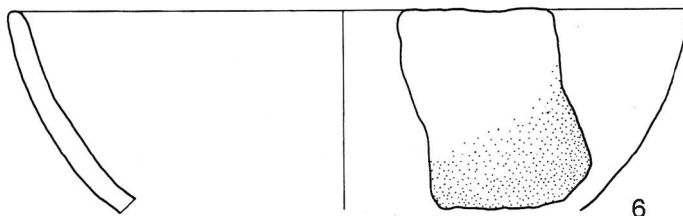
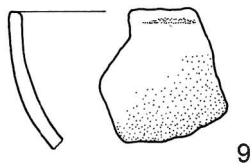
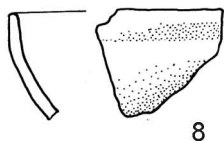
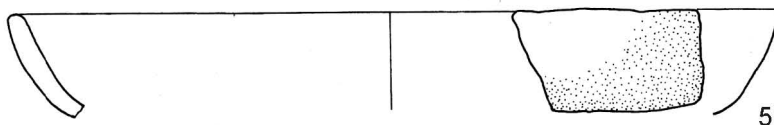
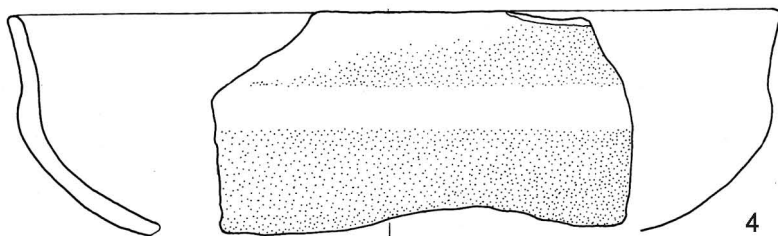
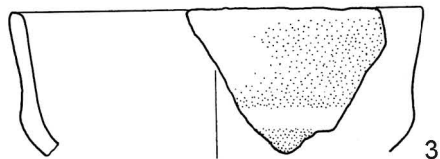
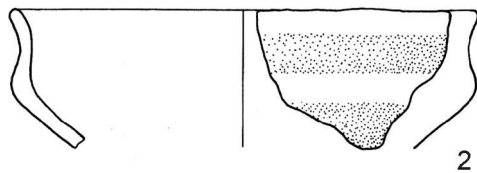
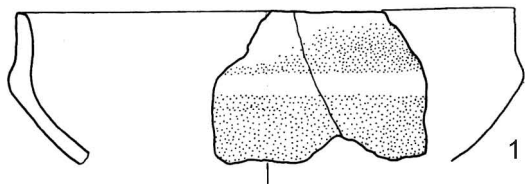

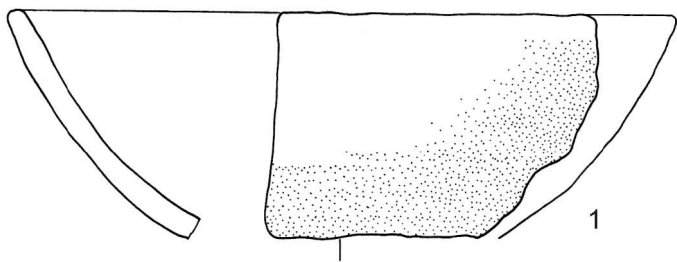

1

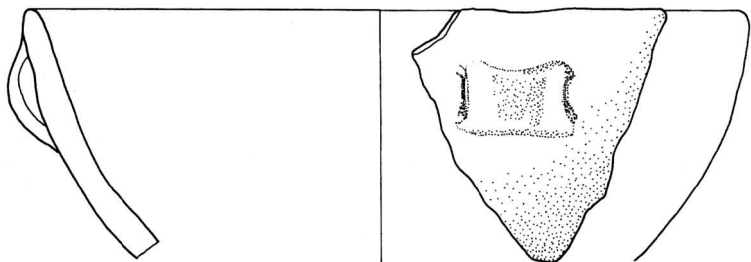

2

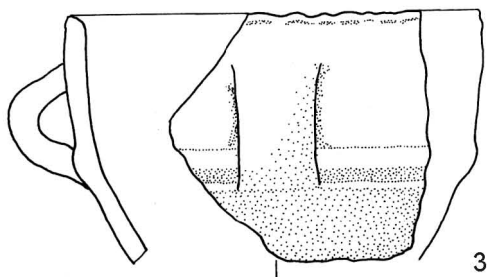
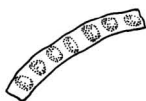

3

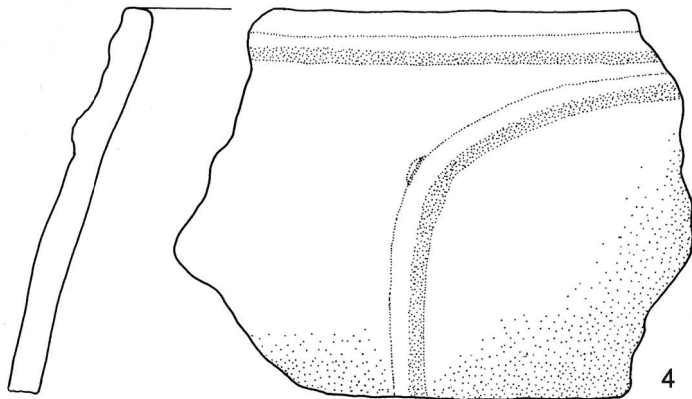
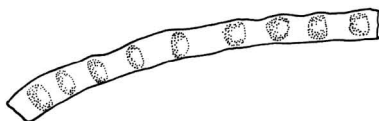

4



5

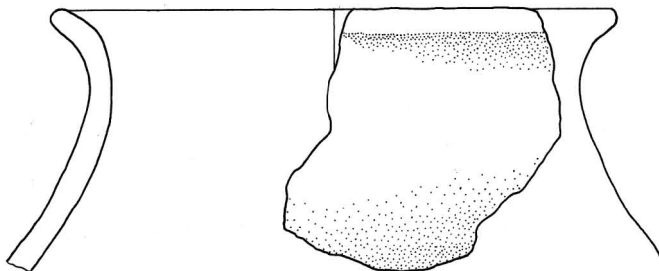

6

Tav. 208 - Noceto La Torretta: frammenti ceramici; 1-6) da US 5017 (scala 1:3).

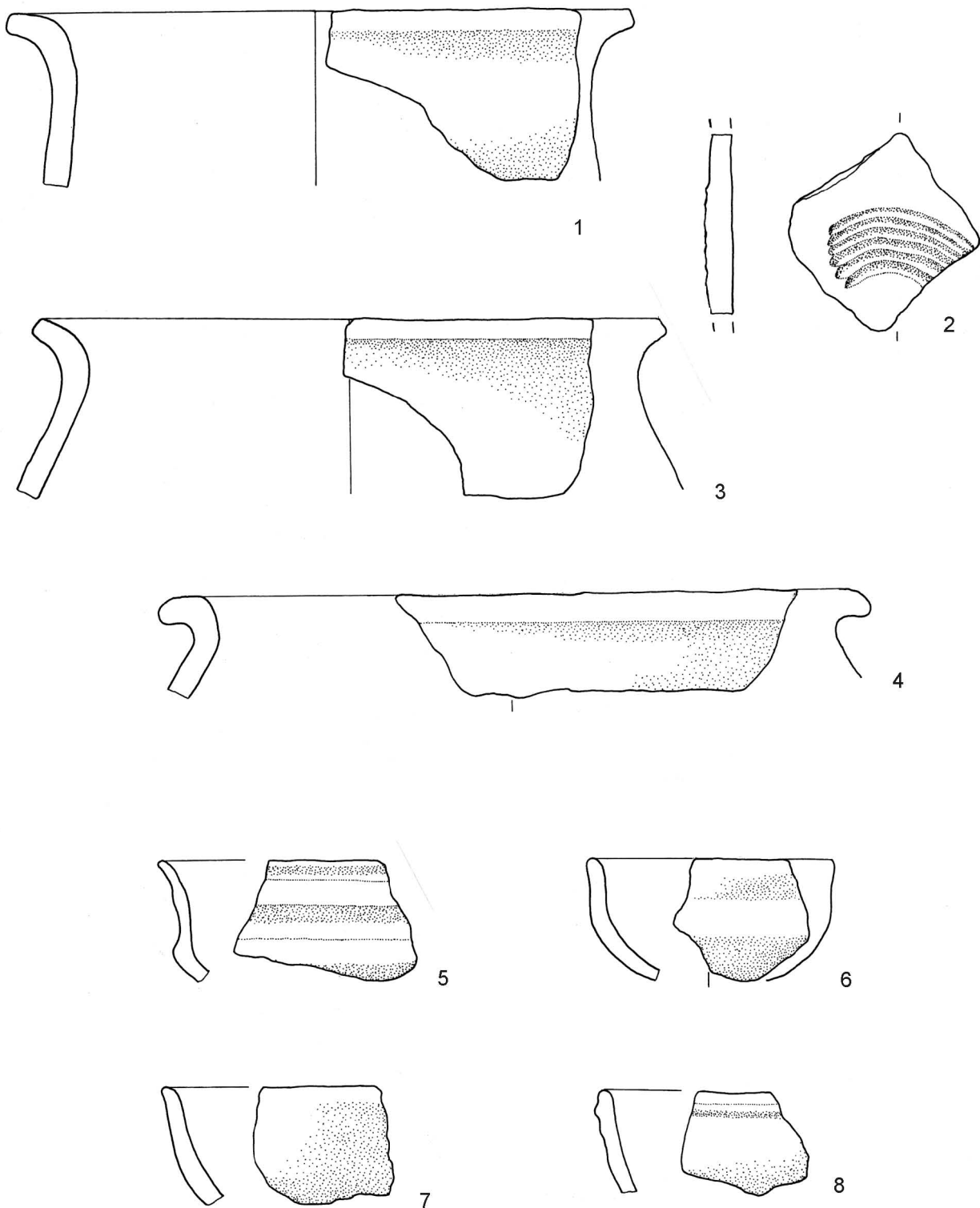

Tav. 209 - Noceto La Torretta: frammenti ceramici; 1-4) da US 5017; 5-8) da US 177 (scala 1:3).

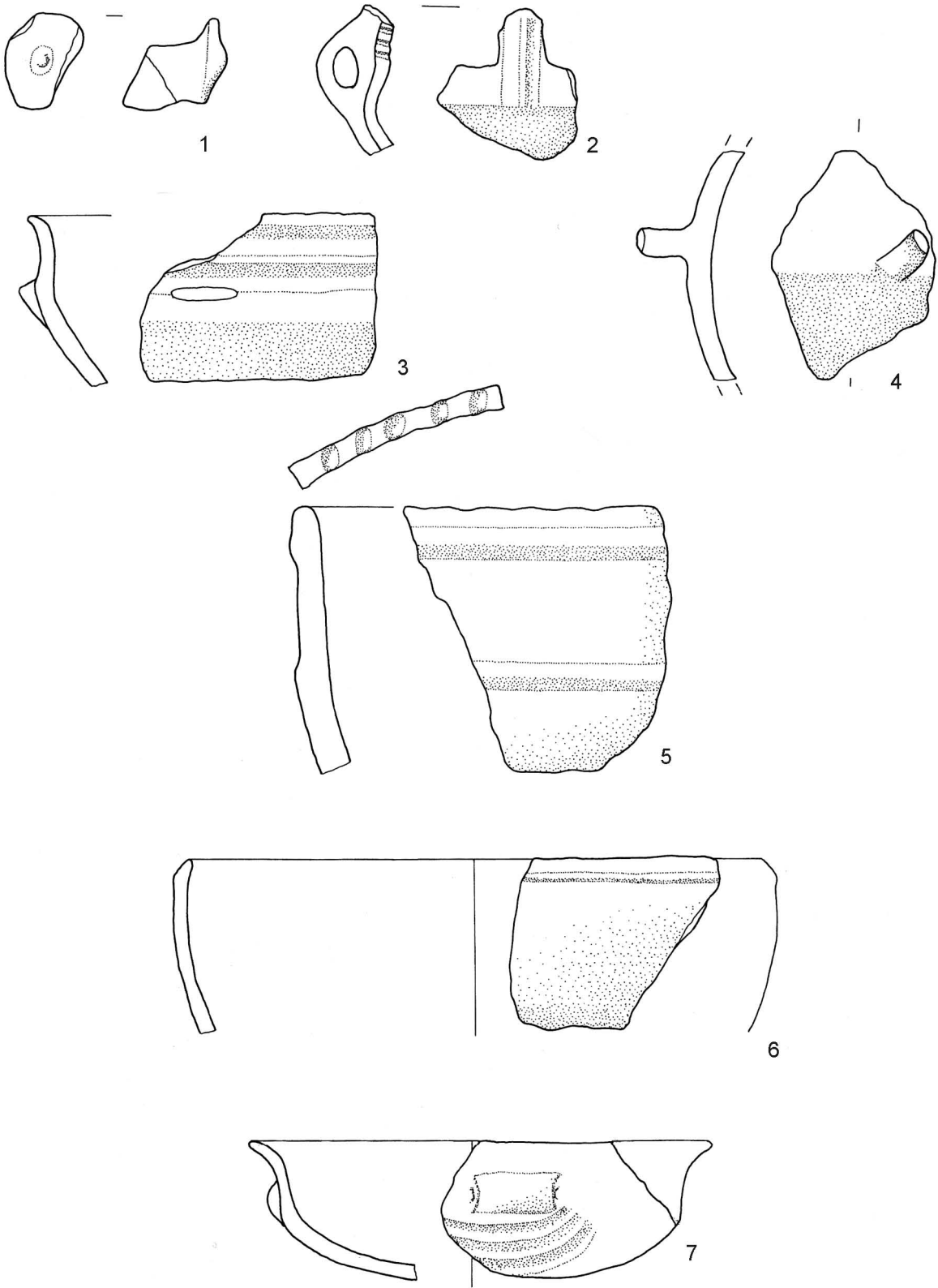

Tav. 210 - Noceto La Torretta: frammenti ceramici; 1) da US 5002fc; 2-4) da US 5002fa; 5) da US 5002f; 6-7) da US 5002c-e (scala 1:3).

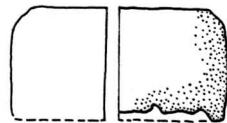
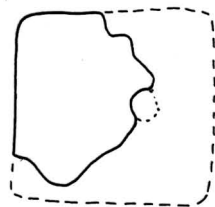
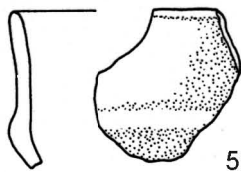
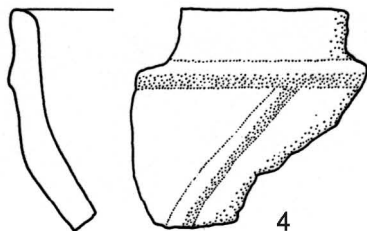
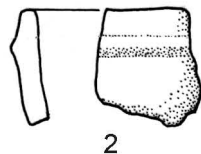
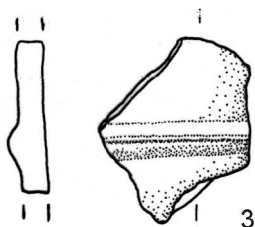
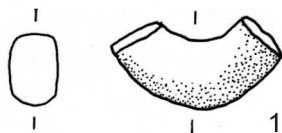

6

Tav. 211 - Cantiere Abruzzese Costruzioni: materiali rinvenuti durante i sondaggi; 1) US 1; 2, 3) US 2; 4, 6) US 3; 5) US 7 (scala 1:3).

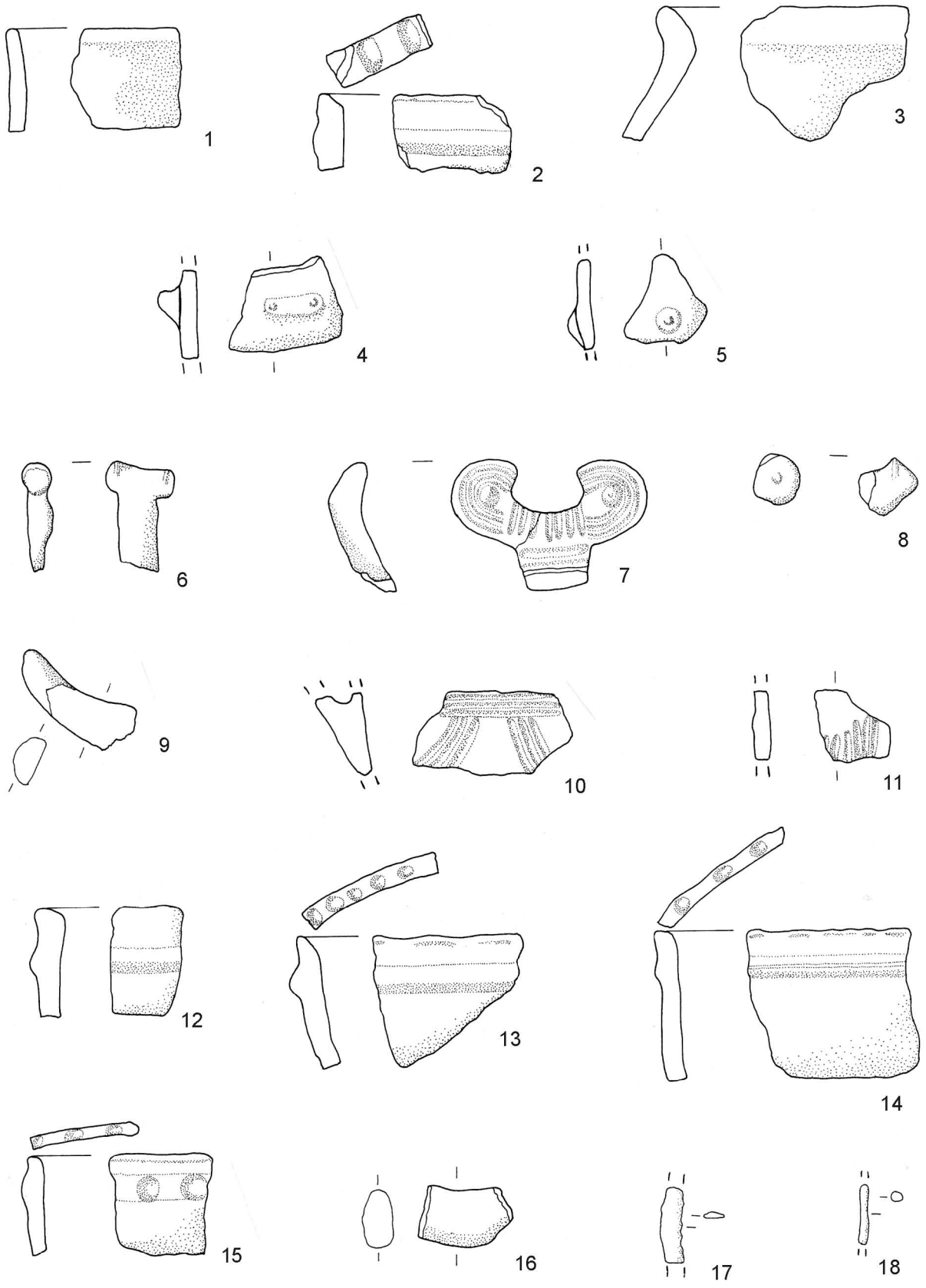

Tav. 212 - Cantiere Turrà e Franzè Costruzioni: materiali rinvenuti durante i sondaggi; 1-5) US 1; 6-16) US 2; 17) US 1; 18) US 2 (1-16 scala 1:3; 17, 18 scala 1:2).

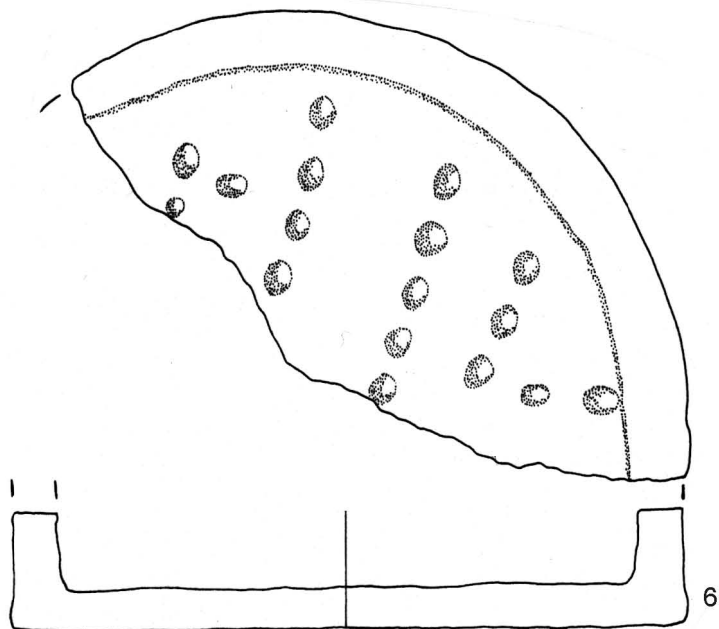
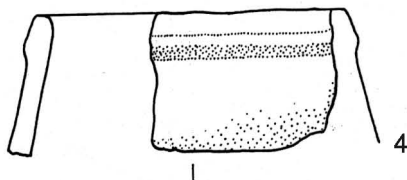
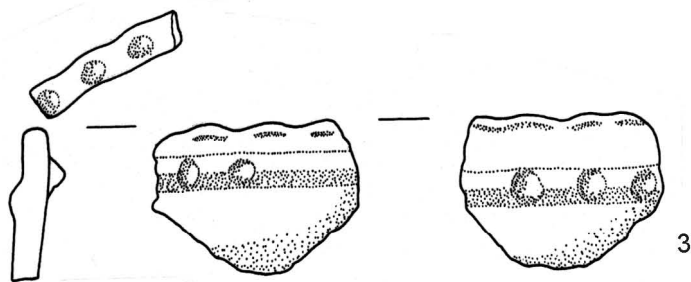
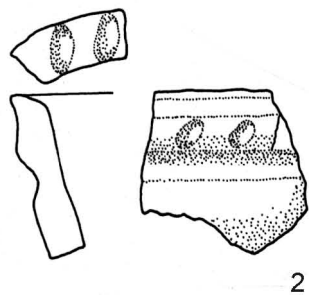
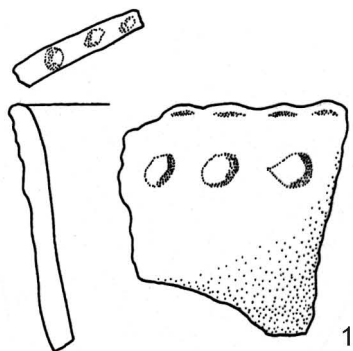

Tav. 213 - Cantiere Paglia Sud: materiali rinvenuti durante i sondaggi (scala 1:3).

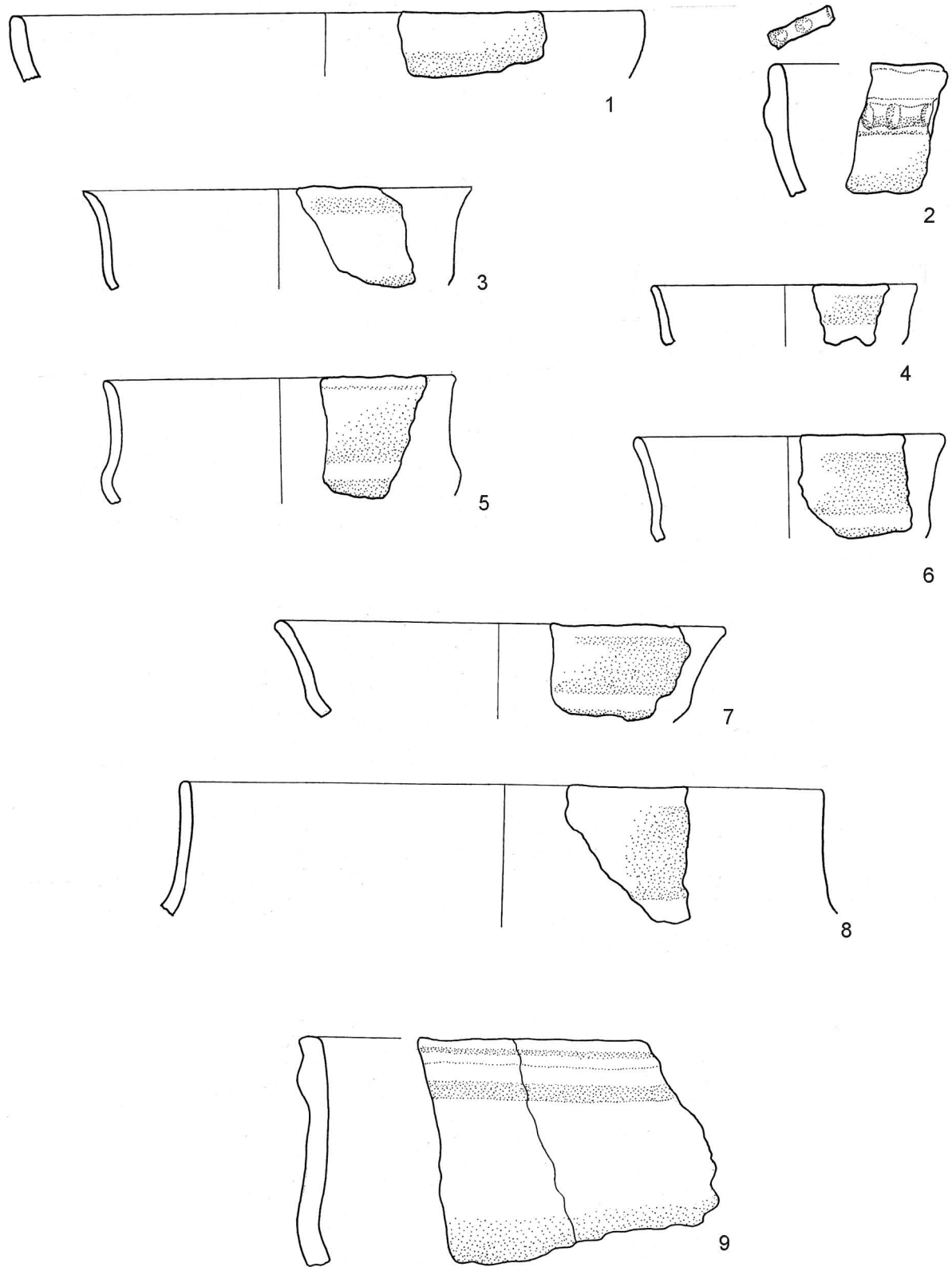

Tav. 214 - Cantiere Bonifica: materiali rinvenuti durante i sondaggi; 1,2) US 3; 3-9) US 4 (scala 1:3).

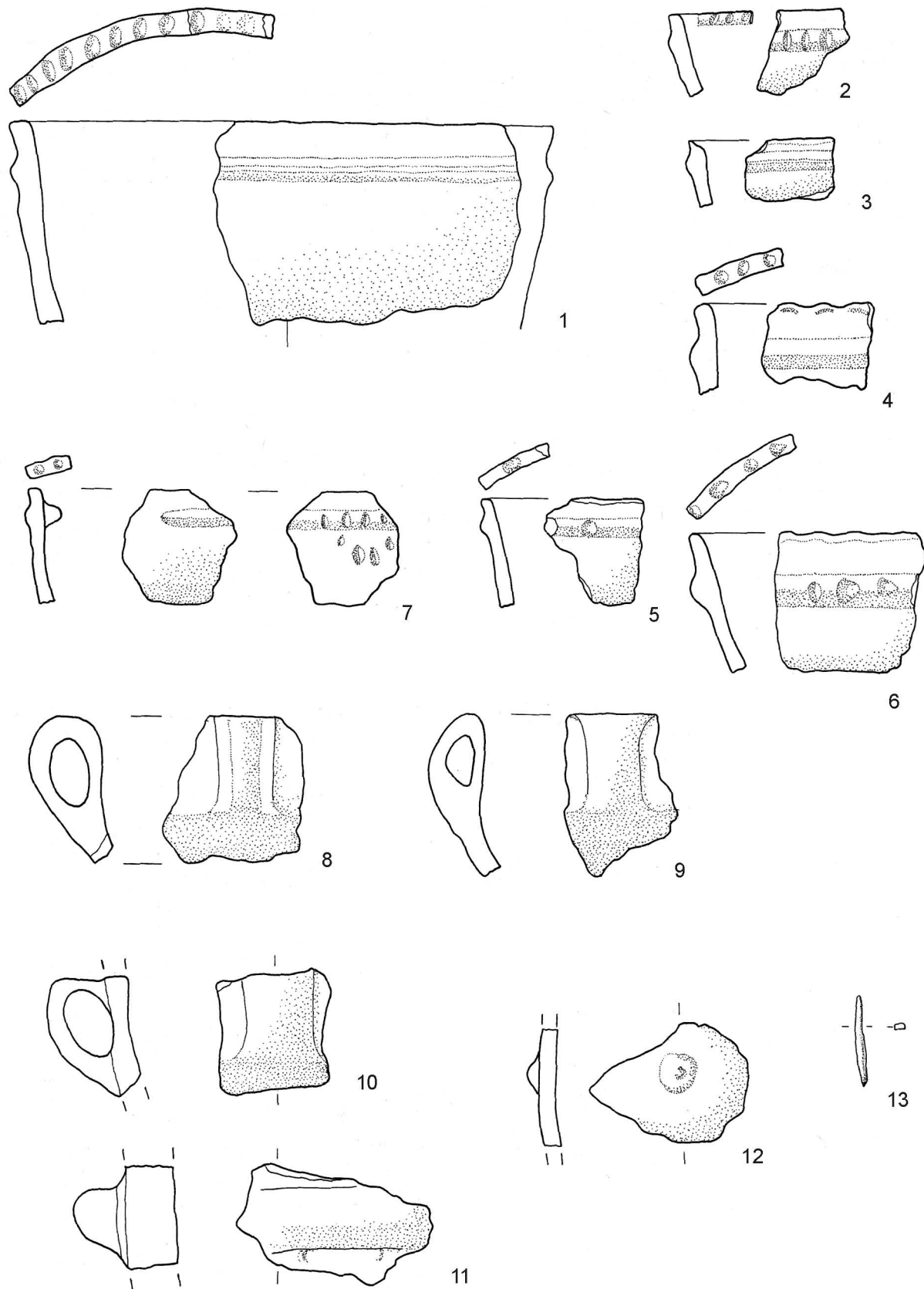

Tav. 215 - Cantiere Bonifica: materiali rinvenuti durante i sondaggi; 1-13) US 4 (1-12 scala 1:3; 13 scala 1:2).

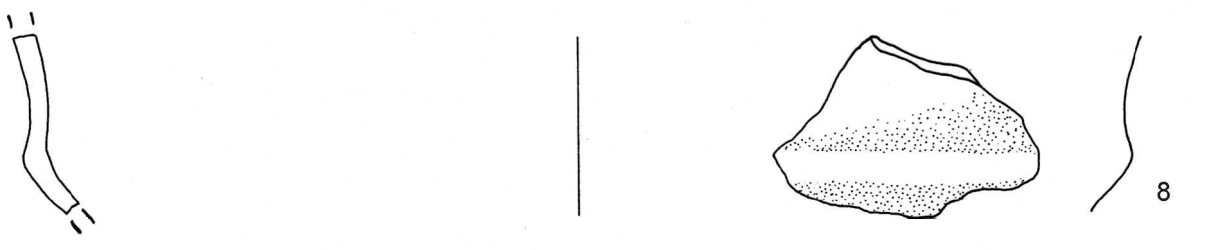
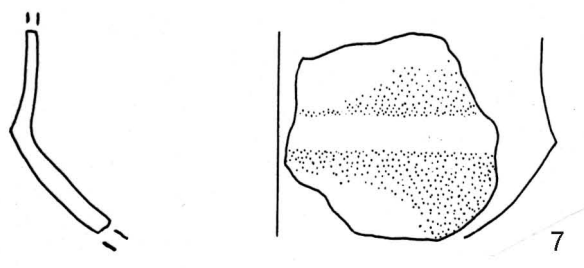
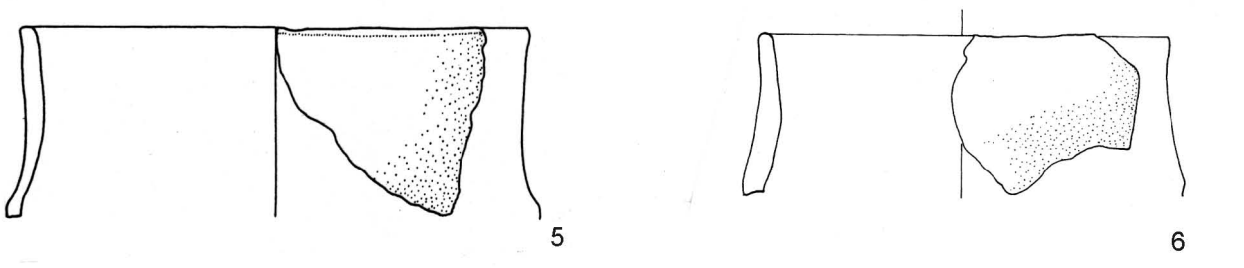
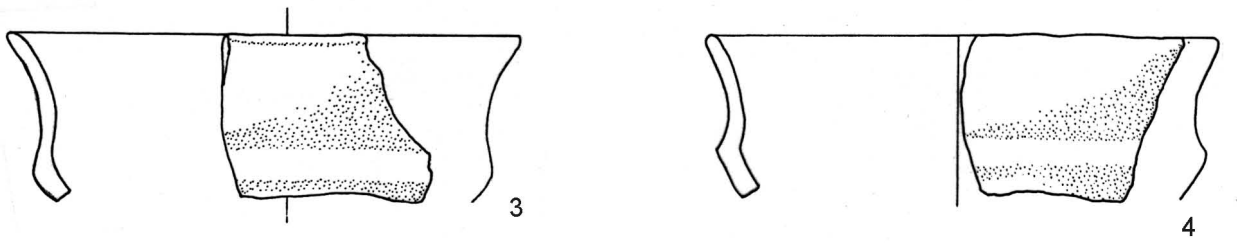
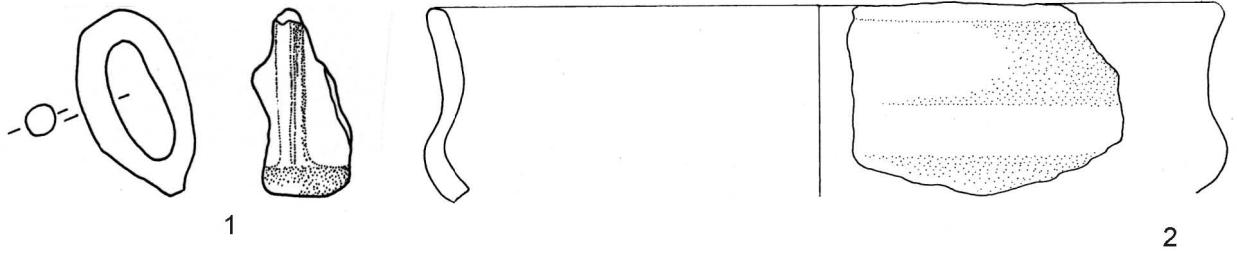

Tav. 216 - Cantiere Bellicchi: materiali rinvenuti durante i sondaggi. (scala 1:3).

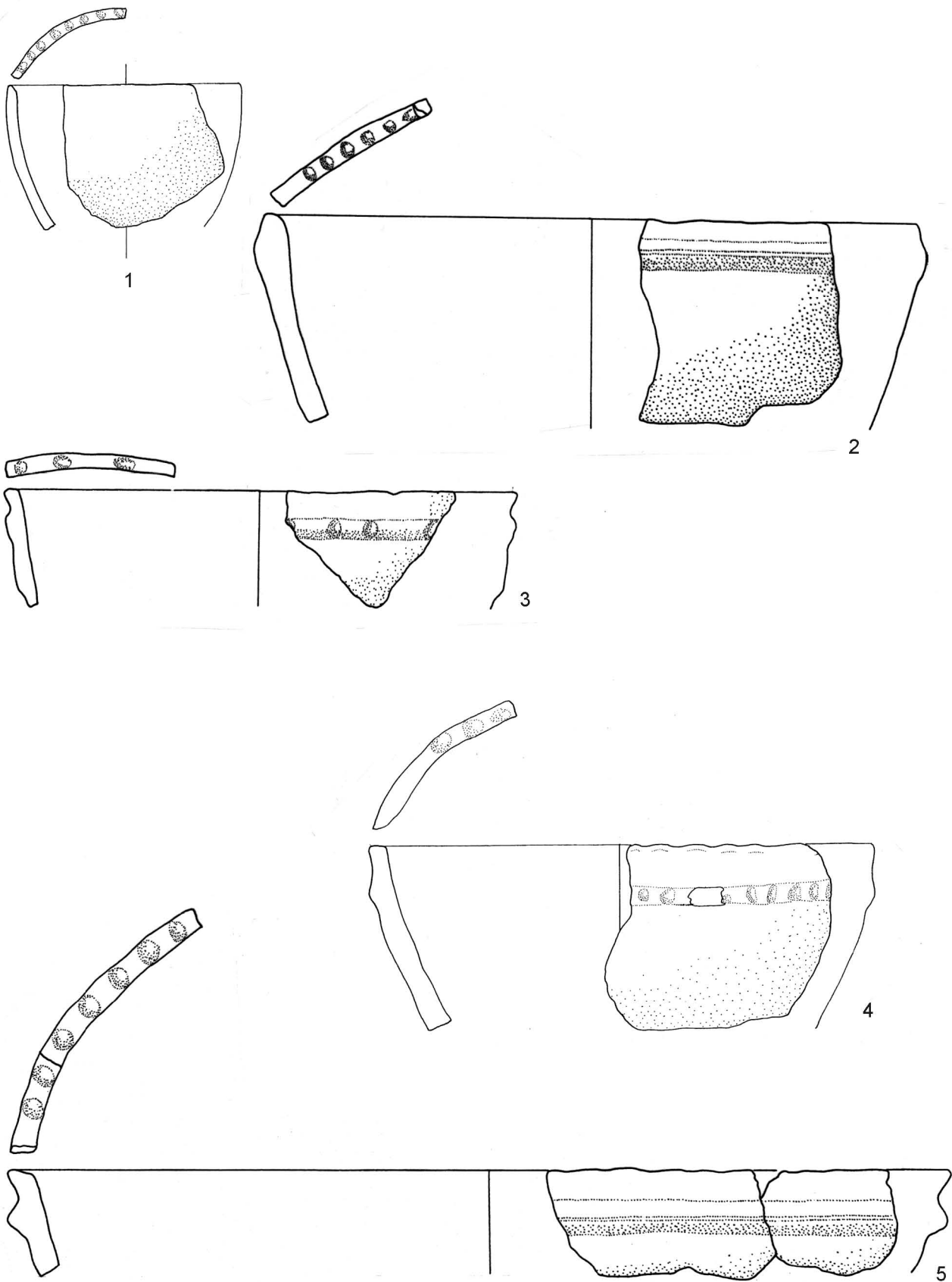

Tav. 217 - Cantiere Bellicchi: materiali rinvenuti durante i sondaggi (scala 1:3).

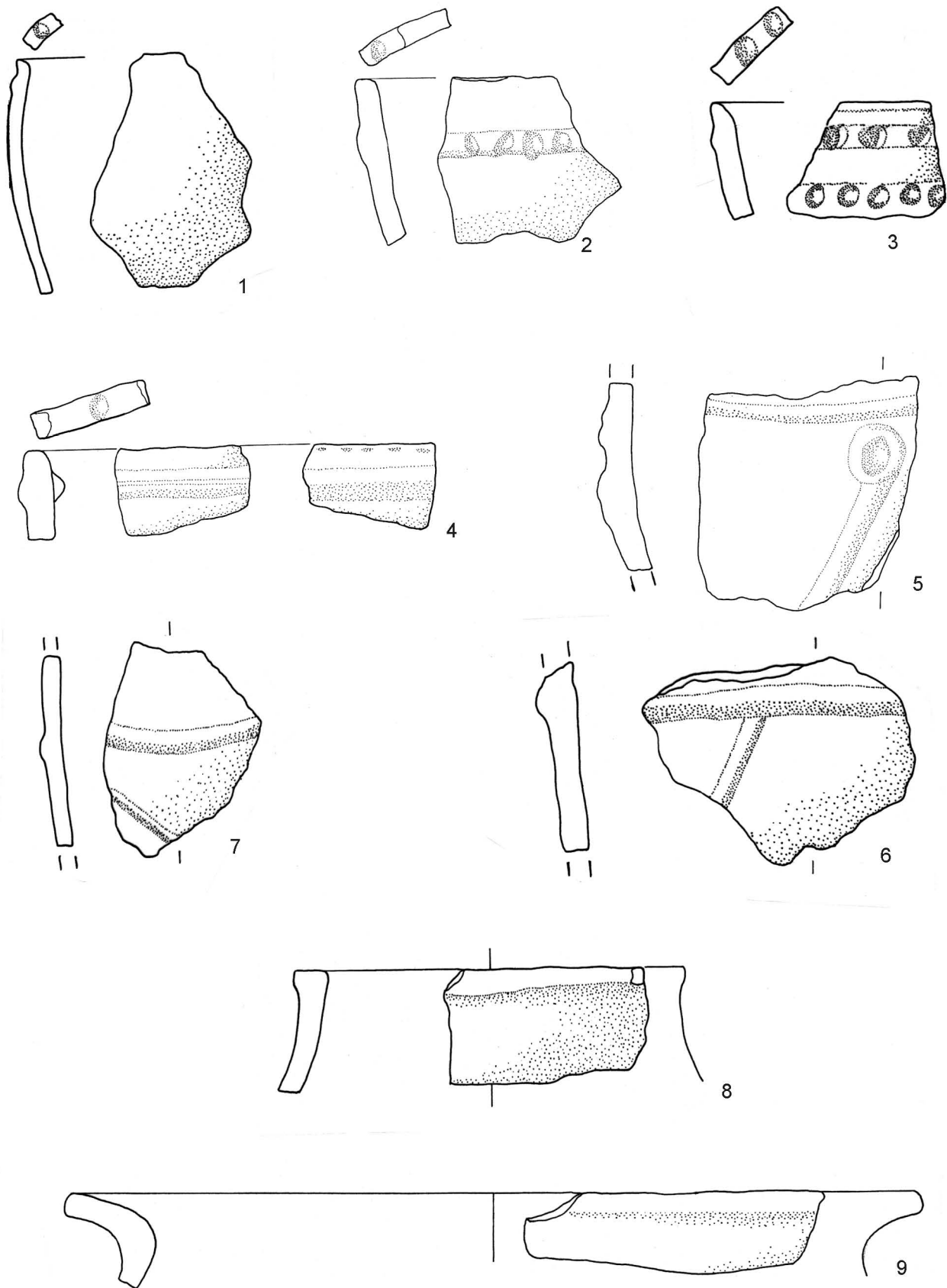

Tav. 218 - Cantiere Bellicchi: materiali rinvenuti durante i sondaggi (scala 1:3).

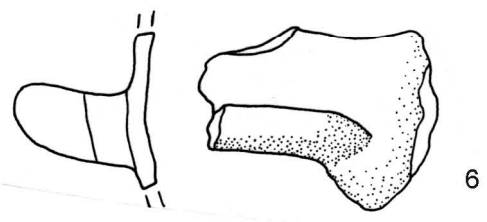
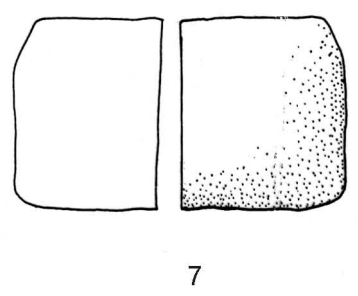
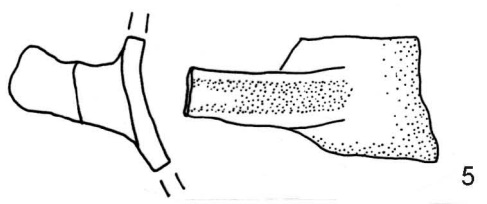
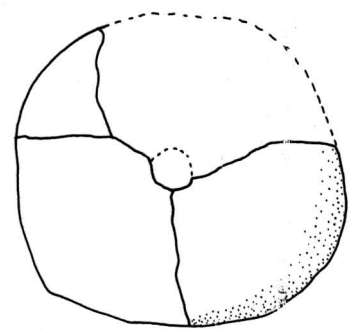
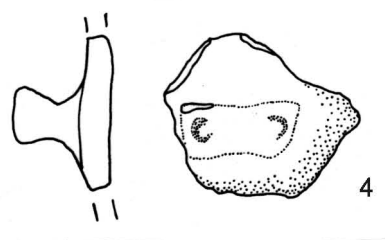
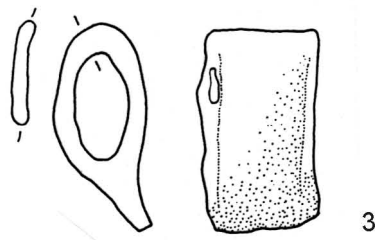
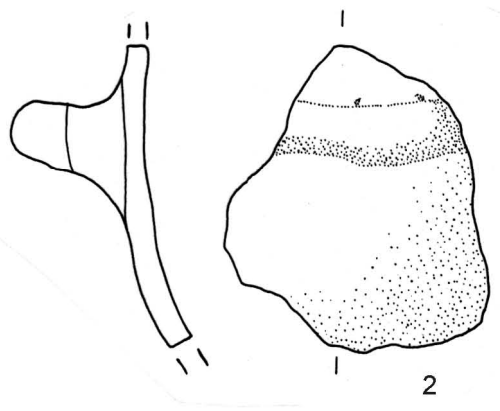
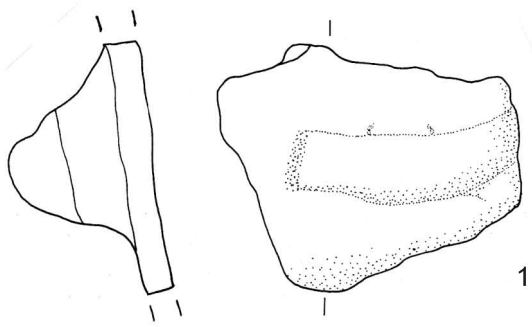

Tav. 219 - Cantiere Bellicchi: materiali rinvenuti durante i sondaggi (scala 1:3).